

Open Frame Display

5.7"~55"



User Manual

Contents

Preface	3
About This User Manual	5
Chapter 1: Introduction	6
1.1 Overview	7
1.2 Product Features	7
1.3 Package Contents	7
1.4 Product Overview	8
1.5 Connector Description	9
1.6 OSD Control Panel	10
1.6.1 OSD Control Panel Location	10
1.6.2 Control Buttons	10
1.6.3 Brightness Adjustment Knob	12
Chapter 2: Installation	13
2.1 Wiring Requirements	14
2.2 Mounting Guide	14
2.2.1 Panel Mount	14
2.2.2 VESA Mount	15
2.3 Cable Mounting Considerations	16
2.4 Connecting Power	16
2.5 Connecting Peripherals	17
2.5.1 VGA Connector	17
2.5.2 USB Connector for Touch	17
2.5.3 HDMI Connector	18
2.5.4 DVI Connector	18
2.5.5 S-Video Connector	18
2.5.6 Composite Video Connector	19
2.5.7 Display Port Connector	19
2.5.8 RS232 Connector for Remote Control	19
Chapter 3: Operating the Device	20
3.1 Turning on the System	21
3.2 OSD Menu Navigation	22
3.3 Troubleshooting Guide	27
Appendix	28
Appendix A: Resolution Table	29
Appendix B: Frequency Table	29
Appendix C: Product Dimensions	30

Preface

Copyright Notice

No part of this document may be reproduced, copied, translated, or transmitted in any form or by any means, electronic or mechanical, for any purpose, without the prior written permission of the original manufacturer.

Trademark Acknowledgement

Brand and product names are trademarks or registered trademarks of their respective owners.

Disclaimer

We reserve the right to make changes, without notice, to any product, including circuits and/or software described or contained in this manual in order to improve design and/or performance. We assume no responsibility or liability for the use of the described product(s) conveys no license or title under any patent, copyright, or masks work rights to these products, and make no representations or warranties that these products are free from patent, copyright, or mask work right infringement, unless otherwise specified. Applications that are described in this manual are for illustration purposes only. We make no representation or guarantee that such application will be suitable for the specified use without further testing or modification.

Warranty

Our warranty guarantees that each of its products will be free from material and workmanship defects for a period of one year from the invoice date. If the customer discovers a defect, we will, at his/her option, repair or replace the defective product at no charge to the customer, provide it is returned during the warranty period of one year, with transportation charges prepaid. The returned product must be properly packaged in its original packaging to obtain warranty service. If the serial number and the product shipping data differ by over 30 days, the in-warranty service will be made according to the shipping date. In the serial numbers the third and fourth two digits give the year of manufacture, and the fifth digit means the month (e. g., with A for October, B for November and C for December).

For example, the serial number 1W16Axxxxxxx means October of year 2016.

Customer Service

We provide a service guide for any problem by the following steps: First, visit the website of our distributor to find the update information about the product. Second, contact with your distributor, sales representative, or our customer service center for technical support if you need additional assistance.

You may need the following information ready before you call:

- Product serial number
- Software (OS, version, application software, etc.)
- Description of complete problem
- The exact wording of any error messages

In addition, free technical support is available from our engineers every business day. We are always ready to give advice on application requirements or specific information on the installation and operation of any of our products.

Advisory Conventions

Four types of advisories are used throughout the user manual to provide helpful information or to alert you to the potential for hardware damage or personal injury. These are Notes, Important, Cautions, and Warnings. The following is an example of each type of advisory.



Note:

A note is used to emphasize helpful information



Important:

An important note indicates information that is important for you to know.



Caution A Caution alert indicates potential damage to hardware and explains how to avoid the potential problem.

Attention Une alerte d'attention indique un dommage possible à l'équipement et explique comment éviter le problème potentiel.



Warning! An Electrical Shock Warning indicates the potential harm from electrical hazards and how to avoid the potential problem.

Avertissement! Un Avertissement de Choc Électrique indique le potentiel de chocs sur des emplacements électriques et comment éviter ces problèmes.



Earth Ground The Protective Conductor Terminal (Earth Ground) symbol indicates the potential risk of serious electrical shock due to improper grounding.

Mise à la Terre Le symbole de Mise à Terre indique le risque potentiel de choc électrique grave à la terre incorrecte.

Safety Information



Warning! Always completely disconnect the power cord from your chassis whenever you work with the hardware. Do not make connections while the power is on. Sensitive electronic components can be damaged by sudden power surges. Only experienced electronics personnel should open the PC chassis.

Avertissement! Toujours débrancher le cordon d'alimentation du chassis lorsque vous travaillez sur celui-ci. Ne pas brancher de connexions lorsque l'alimentation est présente. Des composants électroniques sensibles peuvent être endommagés par des sauts d'alimentation. Seulement du personnel expérimenté devrait ouvrir ces chassis.

Caution Always ground yourself to remove any static charge before touching the CPU card. Modern electronic devices are very sensitive to static electric charges. As a safety precaution, use a grounding wrist strap at all times. Place all electronic components in a static-dissipative surface or static-shielded bag when they are not in the chassis.



Attention Toujours vérifier votre mise à la terre afin d'éliminer toute charge statique avant de toucher la carte CPU. Les équipements électroniques modernes sont très sensibles aux décharges d'électricité statique. Toujours utiliser un bracelet de mise à la terre comme précaution. Placer toutes les composantes électroniques sur une surface conçue pour dissiper les charges, ou dans un sac anti-statique lorsqu'elles ne sont pas dans le chassis.

Safety Precautions

For your safety carefully read all the safety instructions before using the device. Keep this user manual for future reference.

- Always disconnect this equipment from any AC outlet before cleaning. Do not use liquid or spray detergents for cleaning. Use a damp cloth.
- For pluggable equipment, the power outlet must be installed near the equipment and must be easily accessible.
- Keep this equipment away from humidity.
- Put this equipment on a reliable surface during installation. Dropping it or letting it fall could cause damage.
- The openings on the enclosure are for air convection and to protect the equipment from overheating.
- Before connecting the equipment to the power outlet make sure the voltage of the power source is correct.
- Position the power cord so that people cannot step on it. Do not place anything over the power cord.
- If the equipment is not used for a long time, disconnect it from the power source to avoid damage by transient over-voltage.
- Never pour any liquid into an opening. This could cause fire or electrical shock.
- Never open the equipment. For safety reasons, only qualified service personnel should open the equipment.
- All cautions and warnings on the equipment should be noted.
- Always ground yourself to remove any static charge before touching the board.

About This User Manual

This User Manual provides information about using the Winmate® Open Frame Display. The documentation set provides information for specific user needs, and includes:

- **Open Frame Display User Manual** – contains detailed description on how to use the display, its components and features.



Note:

Some pictures in this guide are samples and can differ from actual product.

Document Revision History

Version	Date	Note
1.0	18-Aug-2017	New document release.
1.1	21-Nov-2018	Add 24/28/38/55-inch display.
1.2	2-Feb-2019	Revise format.
1.3	25-Aug-2020	Standard video input change to 1 x VGA (D-sub 15), 1 x HDMI (Type-A).
1.4	9-Sep-2020	Revise resolution table, frequency table.
1.5	20-Nov-2020	Add Appendix C: Product Dimensions.

Chapter 1: Introduction

This chapter gives you product overview, describes features and hardware specification. You will find all accessories that come with the display device in the packing list. Connector description included in this chapter.



1.1 Overview

Congratulations on purchasing Winmate® Open Frame Display. Versatile display in an open-frame housing designed for rear and VESA mounting with integrated bracket design for KIOSK applications..

1.2 Product Features

Winmate® Open Frame Display features:

- 5.7"-55" TFT LCD
- Standard 1 x VGA (D-sub 15), 1 x HDMI (Type-A)
- Open frame housing
- Sleek and flush mounts
- Suitable for industrial applications

1.3 Package Contents

Carefully remove the box and unpack your display. Accessories may vary based on your order .Please check if all the items listed below are inside your package. If any of the ordered items are missing or damaged contact us immediately.



- **User Manual (Hardcopy)**
Part No. 91521112100P



- **Black Screw Bolts***
Varies by product

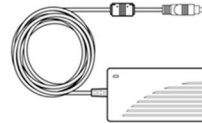

- **110~240V AC Power Adapter**
Varies by product

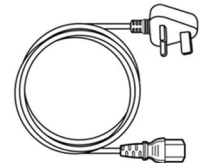

- **Power Cord**
Varies by country

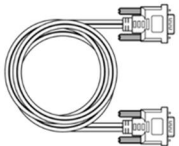

- **VGA Cable**

Part No. 9441151150Q8

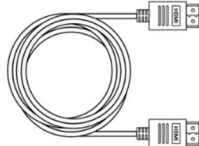

- **HDMI Cable**

Part No. 94E0190190P3

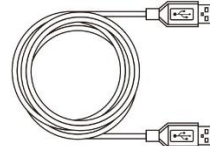

- **USB Cable**

Part No. 948018102100

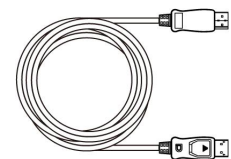

- **Display Port Cable**

Part No. 94E0200200K0

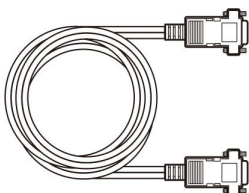

- **RS232 Cable**

Part No. 94G4094090K1

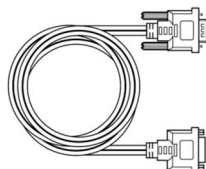

- **DVI Cable**

Part No. 9455295290Q0

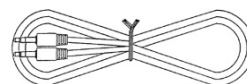

- **Audio Cable**

Part No. 946020100000



- **Remote Control**

Part No. 9B0000000418

**Notice: Screw bolts provided by Winmate only to be used to screw the display onto a console from the rear side. If you prefer your own bolts, please make sure to use M4 and 30mm in length.*

1.4 Product Overview

This section describes physical appearance of the Open Frame Display.



Note: Notice that standard input terminals include VGA and HDMI. Your device may be equipped with other input terminals based on your order.



Note: Notice that input and output connectors may vary by product size and specifications. The picture above shows only a prototype model for information purposes only. The location of OSD panel may vary by model. Refer to a product datasheet for more details.

For product dimensions and VESA dimensions of the specific model, please refer to the [Appendix C](#) of this user manual.



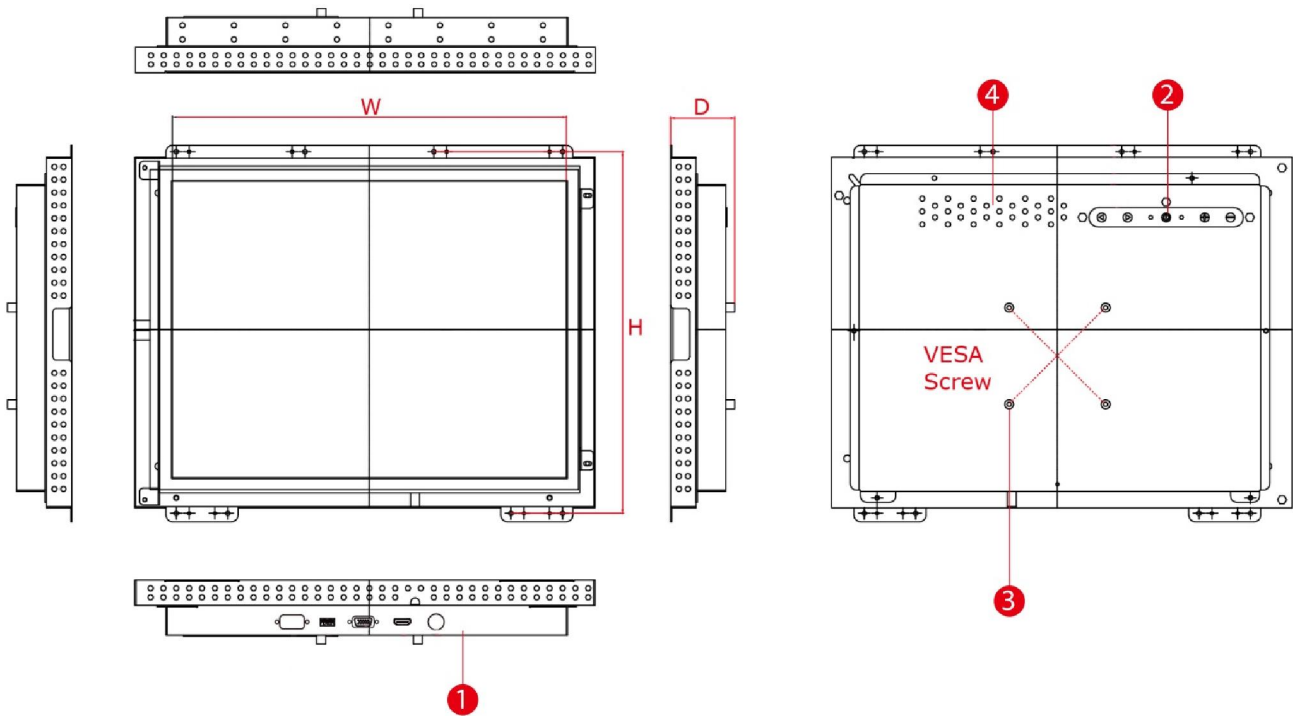







Unit: W x H x D, mm



No	Item	Description
1	I/O Connectors	Use input/ output connectors to connect your display to external devices such as an external PC or notebook, speaker or headphones. Input and output connectors vary by product size and specifications. Standard input terminals include VGA and HDMI. Your device may be equipped with other input terminals based on your order.
2	OSD Control Panel	An on-screen display (OSD) is a control panel on a display allows you to select viewing options and/or adjust components of the display, such as brightness, contrast, and horizontal and vertical positioning.
3	VESA Mount	VESA is a standard used for mounting displays to stands or wall mounts. VESA dimensions vary by display size.
4	Speaker	The speaker generates a sound. Notice that it is an optional feature and may not be present in your device.

1.5 Connector Description

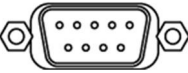
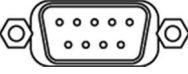
Display input and output connectors are located on the bottom side. Notice that input and output connectors may vary by product size and specifications.

Item	Description
	Power Jack – Connects computer to source of power.
	USB for Touch - Connects USB for touch capabilities.
	VGA (RGB) –Transmits video from a PC to a display. <i>Example: A notebook PC to a display.</i>
	HDMI –Transmits and protects copyrighted digital video and audio. <i>Example: An HD ready TV to a display.</i>
	DVI – Transmits video from a PC to a display. <i>Example: A notebook PC to a display.</i>
	Display Port – Transmits a video signal from a PC to a display. <i>Example: A TV to a display.</i>
	S-Video – Transmits al standard definition video, typically 480i or 576 from a PC to a display. <i>Example: A TV to a display.</i>
	Composite Video (Yellow) – Transmits analog video signal from an external PC to a display. <i>Example: A TV to a display.</i>
	RS232 for Remote Control –For remote control. <i>Example: A remote controller.</i>
	RS232 for Touch – For touch capabilities. <i>Example: A touch to display.</i>
	USB for Touch –For touch capabilities. <i>Example: A touch to display.</i>
	Audio (Green) – Transmits audio signal audio-in. <i>Example: A sound system to a display.</i>

1.6 OSD Control Panel

1.6.1 OSD Control Panel Location

The location of the OSD control panel may vary by model. Please refer to product datasheet for more details.

1.6.2 Control Buttons

OSD control panel varies by product specifications. Refer to a product datasheet to check the OSD control panel type of a particular model.

Type A

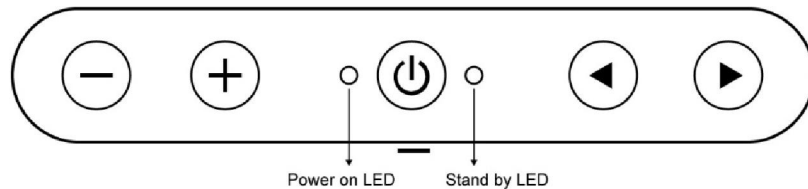

Buttons

Icon	Function
	Decrease the value / Select up
	Increase the value / Select down
	Power switch
	Select left / Exit / Auto adjustment
	Select right / Call main OSD menu / Enter

LED Indicators

Description	Function
Power	Lights up in "Green" when the monitor turn on
Stand by	Lights up in "Orange" when the device cannot detect any input source

Type B

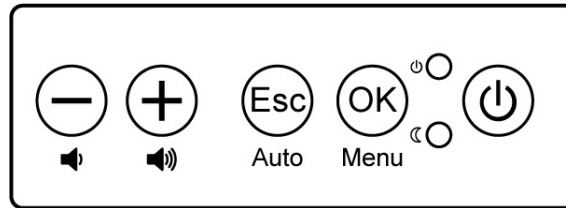

Buttons

Icon	Function
	Decrease the value / Select up
	Increase the value / Select down
	Power switch
 Auto	Select left / Exit / Auto adjustment
 Menu	Select right / Call main OSD menu / Enter

LED Indicators

Icon	Description	Function
	Power	Lights up in "Green" when the monitor turn on
	Stand by	Lights up in "Orange" when the device cannot detect any input source.

Type C

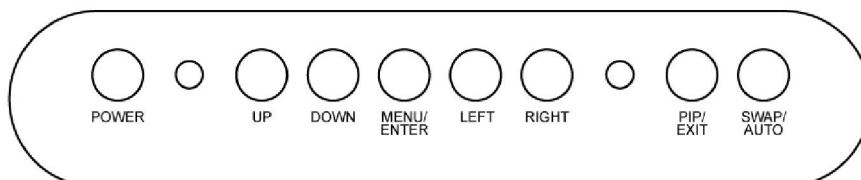

Buttons

Icon	Function
POWER	Power switch
UP	Select up
DOWN	Select down
MENU/ ENTER	Call main OSD menu/ Enter
LEFT	Select left / Decrease the value
RIGHT	Select right / Increase the value / Source
PIP/ EXIT	Opens PIP/ Exit
SWAP/ AUTO	PIP SWAP/ AUTO adjustment







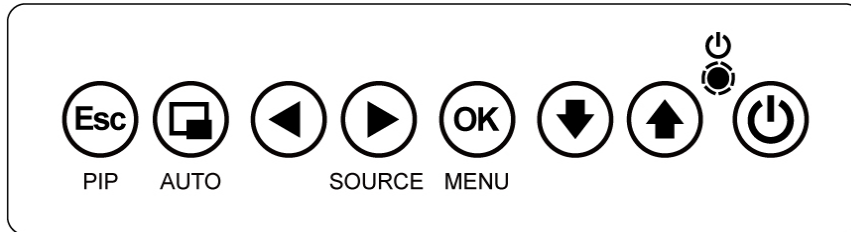

LED Indicators

Description	Function
Power	Lights up in "Green" when the monitor turn on
Stand by	Lights up in "Orange" when the device cannot detect any input source

Type D



Buttons

Icon	Function
 PIP	Exit / PIP
 AUTO	PIP SWAP/ AUTO adjustment
	Select left / Decrease the value
 SOURCE	Select right / Increase the value / Source
 MENU	Enter / Call main OSD menu
	Select down
	Select up
	Power switch

LED Indicators

Description	Function
Power	Lights up in "Green" when the monitor turn on
Stand by	Lights up in "Orange" when the device cannot detect any input source

1.6.3 Brightness Adjustment Knob

Brightness adjustment knob is located on the OSD control panel the rear side of the display.

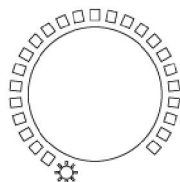

Chapter 2: Installation

This chapter provides hardware installation instructions and mounting guide for all available mounting options. Pay attention to cautions and warning to avoid any damages

2.1 Wiring Requirements

The following common safety precautions should be observed before installing any electronic device:

- Strive to use separate, non-intersecting paths to route power and networking wires. If power wiring and device wiring paths must cross make sure the wires are perpendicular at the intersection point.
- Keep the wires separated according to interface. The rule of thumb is that wiring that shares similar electrical characteristics may be bundled together.
- Do not bundle input wiring with output wiring. Keep them separate.
- When necessary, it is strongly advised that you label wiring to all devices in the system.
- Do not run signal or communication wiring and power wiring in the same conduit. To avoid interference, wires with different signal characteristics (i.e., different interfaces) should be routed separately.
- Be sure to disconnect the power cord before installing and/or wiring your device.
- Verify the maximum possible current for each wire gauge, especially for the power cords. Observe all electrical codes dictating the maximum current allowable for each wire gauge.
- If the current goes above the maximum ratings, the wiring could overheat, causing serious damage to your equipment.

Be careful when handling the unit. When the unit is plugged in, the internal components generate a lot of heat which may leave the outer casing too hot to touch.

2.2 Mounting Guide

The Open Frame Display can be applied for several different installation methods, including panel mount, bracket mount, and VESA mount. Refer to sub-sections below for more details.



Caution Follow mounting instructions and use recommended mounting hardware to avoid the risk of injury.

Attention Suivez les instructions de montage et d'utilisation recommandé le matériel de montage pour éviter le risque de blessure.

2.2.1 Panel Mount

The Open Frame Display Series comes with clamp mounts that enable you to install the unit onto a wall (where space has been cut out to accommodate the rest of the hardware). Winmate provides VESA mount kit by request.

Installation Instruction

1. Make a cutout on the fixture (ex. wall) according to the cutout dimensions of the display.
2. Based on the drawing, mark screw holes on a front side of the fixture. Place display on the fixture from the rear side.
3. Use electric screwdriver to fasten M3 screws from the front side.

4. You complete the installation. Please connect all the peripherals if needed.

1

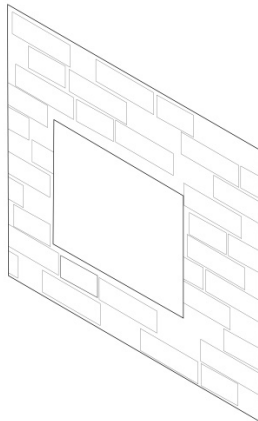

2

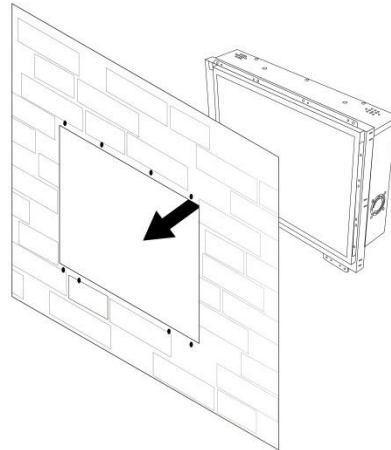

3

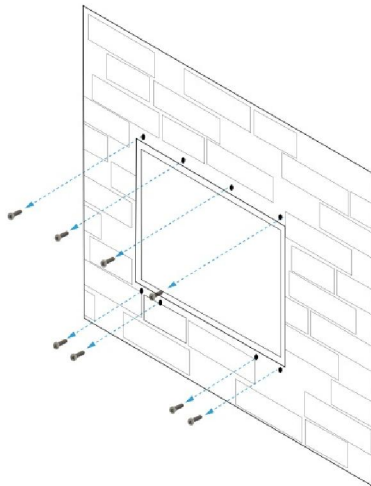

4

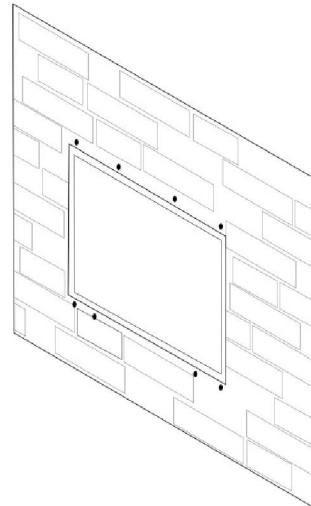

2.2.2 VESA Mount

The Open Frame Display Series comes with VESA mount holes for mounting. Notice that VESA stand and mounting kit are not provided by Winmate.

Installation Instruction:

1. Screw VESA bracket to the fixture (ex. swing arm) with four VESA screws.
2. Place the device on VESA bracket.

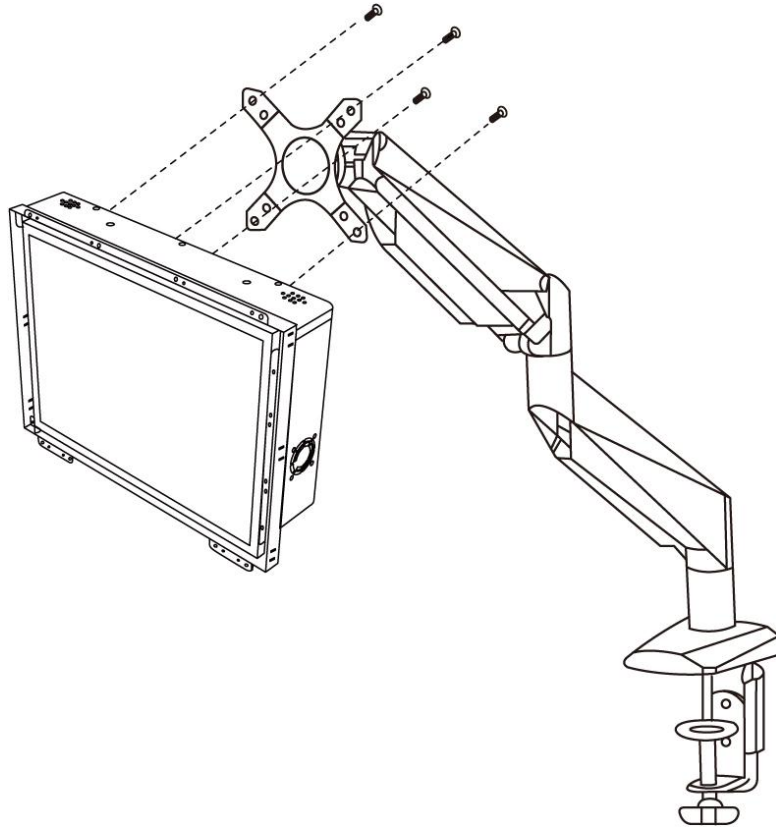

For product VESA dimensions refer to [Appendix C](#) of this user manual.

2.3 Cable Mounting Considerations

For a nice look and safe installation, make sure cables are neatly hidden behind the device.



Caution Observe all local installation requirements for connection cable type and protection level.

Attention Suivre tous les règlements locaux d'installations, de câblage et niveaux de protection.



Caution Turn off the device and disconnect other peripherals before installation.

Attention Éteindre l'appareil et débrancher tous les périphériques avant l'installation.

2.4 Connecting Power

This section provides information on how to use connectors on the Open Frame Display. Be cautious while working with these modules. Please carefully read the content of this chapter in order to avoid any damages.

Installation instruction:

1. Connect the AC cord to the AC IN terminal on the AC adaptor.
2. Connect the DC OUT terminal of the AC adaptor to the DC IN terminal on the monitor.
3. Align the notch on the cord connector with the guiding groove and plug it in.
4. Connect the AC cord plug to the power outlet.

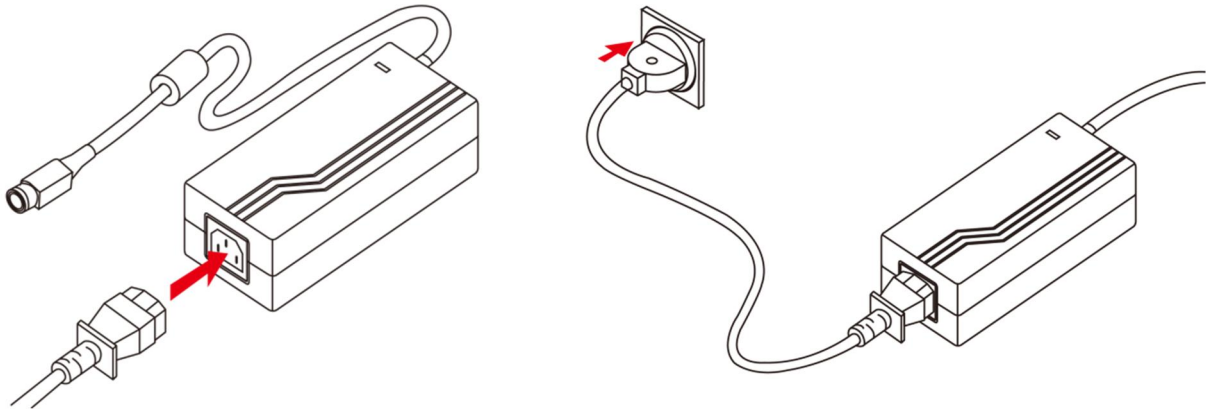

Notice that the type of connector varies based on your order.

2.5 Connecting Peripherals

The panel control port is designed for monitors that work with a variety of compatible video sources. Due to the possible deviations between these signal sources, you may have to make adjustments to the monitor settings from the OSD menu when switching between these sources.

2.5.1 VGA Connector

The Open Frame Display Series uses standard 15pin D-sub connector. Plug 15-pin VGA signal cable to the VGA connector in the rear of motherboard, and plug the other end to the monitor. Secure cable connectors with hexagonal copper pillars M3x4mm.

Pin assignment and signal names of VGA connector

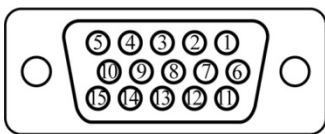

Pin №	Signal Name	Pin №	Signal Name
1	RED	2	GREEN
3	BLUE	4	NC
5	GND	6	AGND
7	AGND	8	AGND
9	VGA_5V	10	GND
11	NC	12	DDCSDA
13	H Sync	14	V Sync
15	DDCSCL		

2.5.2 USB Connector for Touch

Use USB connector for touch capabilities.

Pin assignment and signal names of USB connector for touch



Pin No.	Signal Name	Pin No.	Signal Name
1	+5V	2	Data-
3	Data+	4	GND

2.5.3 HDMI Connector

Plug HDMI signal cable to the HDMI connector on the rear side of PC system, and plug the other end to the monitor.

Pin assignment and signal names of HDMI connector



Pin №	Signal Name	Pin №	Signal Name
1	HDMI_RX2+	2	GND
3	HDMI_RX2-	4	HDMI_RX1+
5	GND	6	HDMI_RX1-
7	HDMI_RX0+	8	GND
9	HDMI_RX0-	10	HDMI_RXC+
11	GND	12	HDMI_RXC-
13	HDMI_CON_CEC	14	NC
15	HDMI_CON_SCL	16	HDMI_CON_SDA
17	GND	18	+5V_HDMI
19	HDMI_CON_HP		

2.5.4 DVI Connector

Use DVI cable to connect your TFT LCD display to the external PC system. Fasten cable connectors with screws.

Pin assignment and signal names of DVI connector



Pin №	Signal Name	Pin №	Signal Name
1	TMDS2-	2	TMDS2+
3	GND	4	TMDS 4-
5	TMDS4+	6	DVI_SCL
7	DVI_SDA	8	NC
9	TMDS1-	10	DVI_RX1+
11	GND	12	TMDS 3-
13	TMDS3+	14	+5V
15	GND	16	DVI_CON_HP
17	TMDS0-	18	TMDS0+
19	GND	20	TMDS5-
21	TMDS5+	22	GND
23	DVI_CLKP	24	DVI_CLKN
C1	NC	C2	NC
C3	NC	C4	NC
C5	NC		

2.5.5 S-Video Connector

Use Mini-DIN connector to connect S-Video to the display.

Pin assignment and signal names of S-Video connector

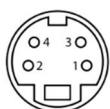

Pin №	Signal Name	Pin №	Signal Name
1	GND	2	GND
3	Y	4	C

2.5.6 Composite Video Connector

Use composite video cable to connect composite video input.

Pin assignment and signal names for Composite Video connector

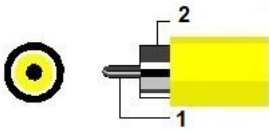

Pin No	Signal Name	Pin No	Signal Name
1	Composite Video Signal	2	GND

2.5.7 Display Port Connector

Use Display Port cable to connect your TFT LCD display to the external PC system.

Pin assignment and signal name of Display Port connector

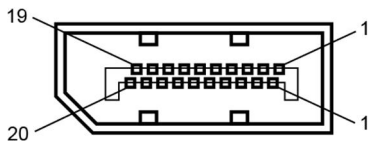

Pin No.	Signal Name	Pin No.	Signal Name
1	Lane 0 P	2	GND
3	Lane 0 N	4	Lane 1 P
5	GND	6	Lane 1 N
7	Lane 2 P	8	GND
9	Lane 2 N	10	Lane 3 P
11	GND	12	Lane 3 N
13	GND	14	GND
15	AUX P	16	GND
17	AUX N	18	Hot Plug
19	Return	20	DP_PWR

2.5.8 RS232 Connector for Remote Control

Use RS232 cable to connect your TFT LCD display to remote control.

Pin assignment and signal name of RS-232 connector for remote control

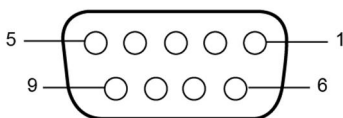

Pin No.	Signal Name	Signal Name
1	DCD	NC (no connection)
2	RXD	Reception data
3	TXD	Transmission data
4	DTR	Data terminal ready
5	GND	GND
6	DSR	Data set ready
7	RTS	Request to send
8	CTS	Short circuit at pin 7 on the display
9	RI	NC (no connection)

Chapter 3: Operating the Device

In this chapter you will find instructions on how to operate the display.



3.1 Turning on the System

To turn on the system:

1. Connect the power adapter cable to the DC IN of the display.
2. Connect the power cord to the power adapter.
3. Connect the power cord to a power outlet.
4. Press the power button  located on the OSD control panel on the rear to turn on the system.

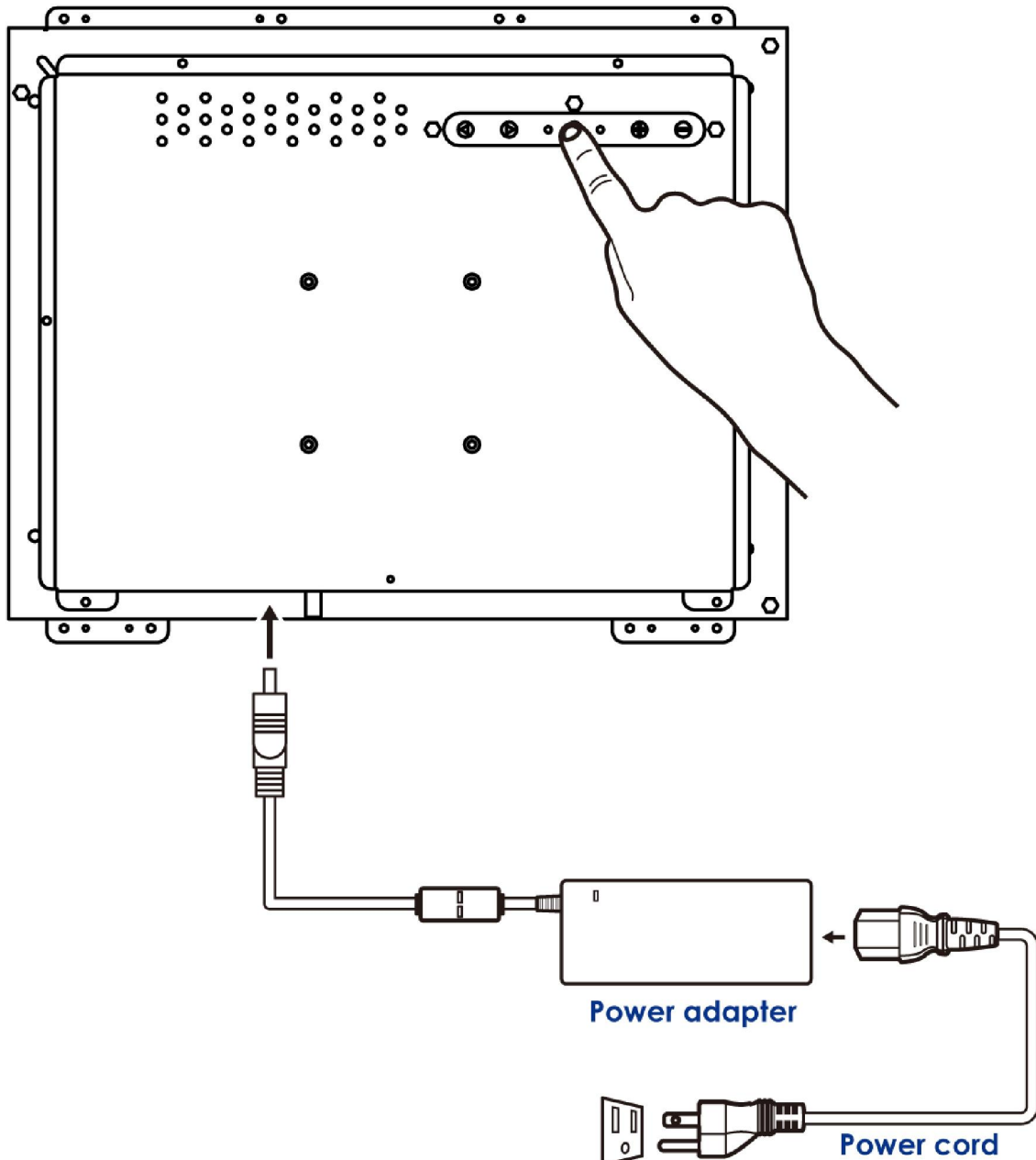

Notice that the type of connector varies based on your order.

3.2 OSD Menu Navigation

The OSD menu varies based on your OSD control panel.

For 5 Key OSD Control Panel



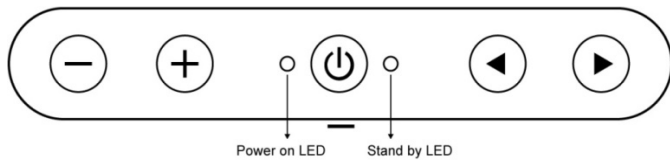

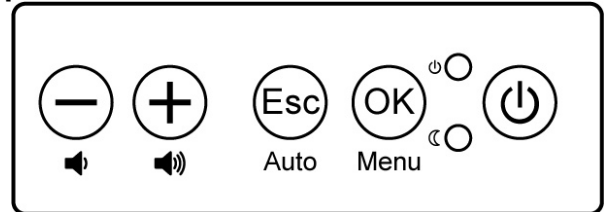

Type A



Type B



OSD Icon	Sub-menu	Settings	Note
 BRICONTRAST	BRIGHTNESS	slider bar	Default 50
	Use to adjust the screen's brightness. Range 0 to 100		
 POSITION	CONTRAST	slider bar	Default 50
	Use to adjust the screen's contrast. Range 0 to 100		
 IMAGE	H POSITION	slider bar	
	Use to adjust the image to the left or right on the screen. Range 0 to 100		
	V POSITION	slider bar	
Use to adjust the image up or down on the screen. Range 0 to 100			
 IMAGE	AUTO	Select and execute	
	Use to choose the best settings for the current input signal		
	CLOCK	slider bar	
	Use to adjust the value of horizontal image. Range 0 to 100		
	PHASE	slider bar	
Use to adjust the phase control (Phase adjustment may be required to optimize the display quality)			
WHITE BALANCE	Select and execute		
Use to set RGB signal voltage level			

OSD Icon	Sub-menu	Settings	Note
 COLOR	USER	R.G.B slider bar	Default USER
	Choose RED/GREEN/BLUE to set value of color temperature brightness to suit your own preference		
	9300K	Select and execute	
	Use to set value of display for the CIE coordinate 9300 color temperature		
	6500K	Select and execute	
	Use to set value of display for the CIE coordinate 6500 color temperature		
	ADC BRIGHTNESS	slider bar	Default 50
Set value of display for ADC Brightness. Range 0 to 100			
 XII GAMMA	GAMMA 0	Select and execute	Default GAMMA0
	Choose the parameter of GAMMA 0 as default setting.		
	GAMMA 1	Select and execute	
	Choose the parameter of GAMMA 1 as default setting.		
	GAMMA 2	Select and execute	
Choose the parameter of GAMMA 2 as default setting.			
 OP OPTION	VR Brightness	ON/OFF	Default OFF (Optional Function)
	Choose the brightness control mode by VR control		
	Volume	slider bar	Default 10
	Use to set value of Volume		
	Speaker	ON/OFF	Default OFF
Use to set value of Volume Speaker			
 CHANNEL	AUTO SCAN	Select and execute	Default mode
	Auto detect the input source		
	ANALOG	Select and execute	
	Switch the setting of signal input to Analog mode		
HDMI/ DVI/ DP	Select and execute	Optional	
Switch the setting of signal input to HDMI mode			
 RECALL	YES	Select and execute	
	Recall the factory default setting		
	NO	Select and execute	
Return to main menu			
 EXIT	YES	Select and execute	
	Exit the OSD menu		
	NO	Select and execute	
Return to main menu			

For 8 Key OSD Control Panel

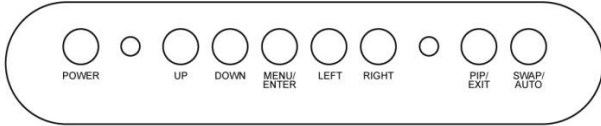

Type C



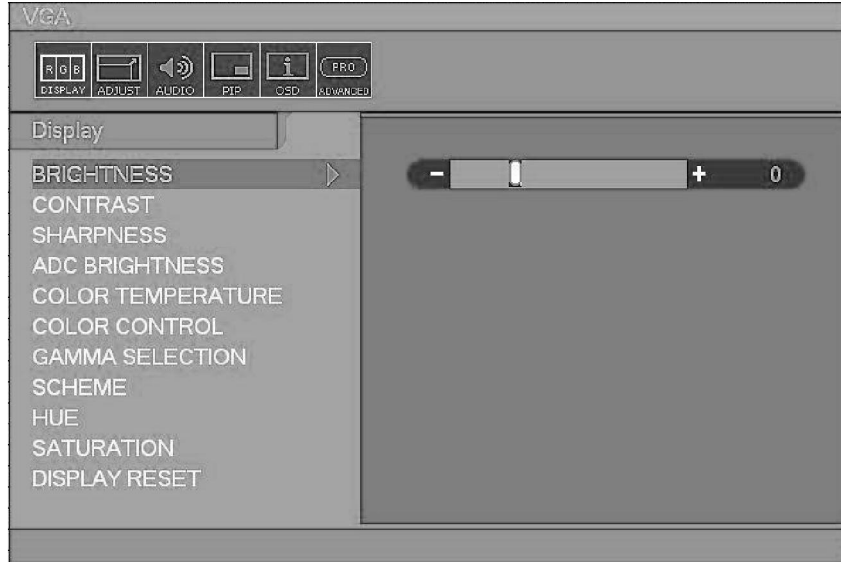
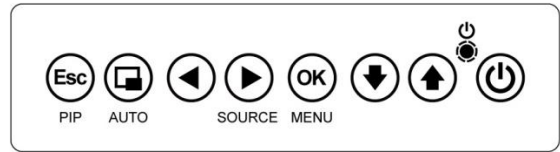

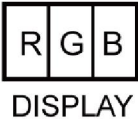
Type D

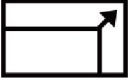

OSD icon	Sub-menu	Settings	Note
	BRIGHTNESS	slider bar	
	Adjusts the overall image and background brightness. Press “◀” or “▶” to adjust.		
	CONTRAST	slider bar	
	Adjusts the image brightness in relationship to the background. Press “◀” or “▶” to adjust.		
	SHARPNESS	slider bar	
	Adjusts the crispness of the image. Press “◀” or “▶” to adjust.		
	ADC BRIGHTNESS *VGA CHANNEL ONLY	slider bar	
	Adjusts the ADC brightness. Press “◀” or “▶” to adjust.		
	COLOR TEMPERATURE	USER/6500K/9300K	
	Adjusts the color temperature of the entire screen. A low color temperature will make the screen reddish. A high color temperature will make the screen bluish.		
	COLOR CONTROL	R slider bar	
		G slider bar	
		B slider bar	
		Y slider bar	
		M slider bar	
Adjusts the levels of the Red, Green, Blue, Yellow, magenta, and cyan. Press “◀” or “▶” to adjust.			
GAMMA SELECTION	@NATIVE		
	@1.8		
	@2.2		
Select a display gamma value for best picture quality.			
SCHEME	USER		
	GAME		
	SPORT		
	VIVID		
	CINEMA		
Select scheme for different default setting combination.			
DISPLAY RESET	YES/NO		
Resets the following settings within the DISPLAY menu back to factory setting:			

OSD icon	Sub-menu	Settings	Note
 ADJUST	AUTO SETUP *VGA CHANNEL ONLY	PRESS YES TO AUTO SETUP	
	Automatically adjusts screen size, H position, V position, Clock, Clock Phase		
	AUTO ADJUSTMENT *VGA CHANNEL ONLY	ON/OFF	
	H Position, V Position and Clock Phase are adjusted automatically upon power on.		
	H POSITION *VGA CHANNEL ONLY	slider bar	
	Controls the horizontal position of the image within the Display area of the LCD. Press + to move right. Press - to move left.		
	V POSITION *VGA CHANNEL ONLY	slider bar	
	Controls the vertical position of the image within the Display area of the LCD. Press + to move up. Press - to move down.		
	CLOCK *VGA CHANNEL ONLY	slider bar	
	Press + to expand the width of the image on the right of the screen. Press - to narrow the width of the image on the left.		
	PHASE *VGA CHANNEL ONLY	slider bar	
	Adjusts the visual "noise" on the image.		
	WHITE BALANCE *VGA CHANNEL ONLY	YES/NO	
	Perform the white balance		
	SCALING	@ ASPECT	
		@ OFF	
@ FULL			
Adjust the image scaling setting			
ADJUST RESET	YES/NO		
Resets the following settings within the ADJUST menu back to factory setting.			
 AUDIO	VOLUME	slider bar	
	MUTE	ON/OFF	
	AUDIO RESET	YES/NO	
	Resets "AUDIO" settings back to factory settings.		
 PIP	PIP SOURCE	VGA	
		DVI	
		Composite	
		S-Video	
	PIP MODE	@OFF	
		@LARGE PIP	
		@SMALL PIP	
		@SIDE BY SIDE ASPECT	
		@SIDE BY SIDE FULL	
	Selects the size of the sub-picture used in Picture-in-Picture (PIP) mode.		
	PIP POSITION	BOTTOM RIGHT	
		TOP RIGHT	
TOP LEFT			
BOTTOM LEFT			
Determines where the PIP appears on the screen.			
PIP RESET	YES/NO		
Resets the following settings within the PIP menu back to factory setting.			

OSD icon	Sub-menu	Settings	Note
 OSD	OSD TURN OFF	slider bar	
	Turns off the OSD after a period of inactivity. The preset choices are 0-60 seconds.		
	OSD POSITION	H - slider bar	
		V - slider bar	
	Determines the location where the OSD appears on the screen.		
	OSD TRANSPARENCY	@OFF	
		@TYPE1	
		@TYPE2	
	set the transparency level of OSD.		
	OSD Rotated	@OFF	
		@90	
		@270	
	Set to rotate the OSD menu.		
	MONITOR INFORMATION	Version	
		Panel Resolution	
Main Resolution			
PIP Resolution			
Show BIOS version & resolution info.			
OSD RESET	YES/NO		
Resets the following settings auto.			
 ADVANCED	CHANNEL SELECT	VGA	
		AUTO	
		DVI	
		CVBS	
		SVIDEO	
	Select the input signal source.		
	FLIP	@OFF	
		@H-FLIP	
		@V-FLIP	
		@HV-FLIP	
Adjust the flip settings.			
BRIGHTNESS MIN	Slider bar		
SCAN MODE	OVER SCAN		
	UNDER SCAN		
ADVANCED RESET	YES/NO		
Resets the following settings within the ADVANCED menu back to factory setting.			
FACTORY RESET	YES/NO		
Resets OSD options back to factory settings EXCEPT FOR: CHANGE SECURITY PASSWORD and SECURITY PASSWORD.			

3.3 Troubleshooting Guide

If your display fails to operate correctly, check the following chart for possible solution before calling for repairs:

Condition	Check Point
The picture does not appear	<ul style="list-style-type: none"> ✓ Check if the signal cable is firmly seated in the socket. ✓ Check if the Power is ON at the computer ✓ Check if the brightness control is at the appropriate position, not at the minimum.
The screen is not synchronized	<ul style="list-style-type: none"> ✓ Check if the signal cable is firmly seated in the socket. ✓ Check if the output level matches the input level of your computer. ✓ Make sure the signal timings of the computer system are within the specification of the display. ✓ If your computer was working with a CRT display, you should check the current signal timing and turn off your computer before you connect the VGA Cable to this display.
The position of the screen is not in the center	<ul style="list-style-type: none"> ✓ Adjust the H-position, and V-position, or Perform the Auto adjustment.
The screen is too bright (too dark)	<ul style="list-style-type: none"> ✓ Check if the brightness or contrast control is at the appropriate position, not at the Maximum (Minimum).
The screen is shaking or waving	<ul style="list-style-type: none"> ✓ Perform the Auto adjustment. ✓ Moving all objects which emit a magnetic field such as motor or transformer, away from the display. ✓ Check if the specific voltage is applied. ✓ Check if the signal timing of the computer system is within the specification of display.

If you are unable to correct the fault by using this chart, stop using your display and contact your distributor or dealer for further assistance.

Appendix

This chapter contains additional product information, including troubleshooting guide and frequency table



Appendix A: Resolution Table

V-VGA, D-DVI, H-HDMI

Resolution Support Table																																	
Panel Size	5.7"/6.5"			7"			8"/8.4"/12.1"			7"/10.1"			10.4"/12.1"/15"			10.1"/12.1"			17"/19"			15.6"/18.5"			20.1"/23.1"			15.6"/18.5"/21.5"/23.8"/27"/32"/42"			10.1"/24"		
Panel Native Resolution	640x480			800x480			800x600			1024x600			1024x768			1280x800			1280x1024			1366x768			1600x1200			1920x1080			1920x1200		
support resolution	V	D	H	V	D	H	V	D	H	V	D	H	V	D	H	V	D	H	V	D	H	V	D	H	V	D	H	V	D	H	V	D	H
640*480 (4:3)	V	V	V	V	V	V	V	V	V	V	V	V	V	V	V	V	V	V	V	V	V	V	V	V	V	V	V	V	V	V			
480P			V		V			V			V			V			V			V			V			V			V				
800*480				V	V	V																											
800*600 (4:3)							V	V	V	V	V	V	V	V	V	V	V	V	V	V	V	V	V	V	V	V	V	V	V	V	V		
1024*768 (4:3)													V	V	V	V	V	V	V	V	V	V	V	V	V	V	V	V	V	V	V		
1280*720 (16:9) 720P			V		V			V			V			V			V			V	V	V	V		V	V	V	V	V	V	V		
1280*768																						V	V	V									
1280*800 (16:10)																V	V	V									V	V	V	V	V		
1280*1024 (5:4)																			V	V	V				V	V	V	V	V	V	V		
1366*768																						V	V	V									
1400*1050 (4:3)																									V	V	V						
1440*900 (16:10)																										V	V	V	V	V	V		
1600*1200 (4:3)																									V	V	V						
1680*1050 (16:10)																										V	V	V	V	V	V		
1920*1080 (16:9)1080P			V		V			V			V			V			V			V			V		V	V	V	V	V	V	V		
1920*1200 (16:10)																													V	V	V		

Appendix B: Frequency Table

Frequency Table				
	Vertical Frequency	V	D	H
640*480(4:3)	60	V	V	V
	72	V		
	75	V		
480P	60	V	V	V
800*480	60	V	V	V
800*600(4:3)	60	V	V	V
	72	V		
	75	V		
1024*768(4:3)	60	V	V	V
	75	V		
1280*720(16:9) 720P	60	V	V	V
1280*768	60	V	V	V
1280*800(16:10)	60	V	V	V
1280*1024(5:4)	60	V	V	V
	75	V		
1366*768	60	V	V	V
1400*1050(4:3)	60	V	V	V
1440*900(16:10)	60	V	V	V
1600*1200(4:3)	60	V	V	V
1680*1050(16:10)	60	V	V	V
1920*1080(16:9)1080P	60	V	V	V
1920*1200(16:10)	60	V	V	V

Appendix C: Product Dimensions

Model Name	Dimensions	Cutout	VESA
	(W x H x D, mm)	(W x H, mm)	(W x H, mm)
R05T100-OFD1HB	168.4 x 132.8 x 38.6 mm	152.6 x 134.8 mm	N/A
R06L200-OFA1	249 x 142.8 x 37.1 mm	188.4 x 145.8 mm	N/A
R08L200-OFU1	251.2 x 174.8 x 49 mm	236.18 x 175.78 mm	75 x 75 mm
R08L200-OFU1TR	251 x 174 x 49 mm	238 x 177.8 mm	75 x 75 mm
R08T100-OFA1	221 x 163 x 45.9 mm	205.81 x 163.8 mm	75 x 75 mm
R08T200-OFT1HB	251.2 x 174.8 x 49 mm	238.4 x 177.8 mm	75 x 75 mm
R10L100-OFP3	260 x 215 x 40 mm	200.02 x 263 mm	75 x 75 mm
R10L100-OFT2	260 x 215 x 38 mm	263 x 199 mm	75 x 75 mm
R10L100-OFT2HB	260 x 215 x 38 mm	263 x 199 mm	75 x 75 mm
R10L600-OFP1	260 x 215 x 35 mm	263 x 200 mm	75 x 75 mm
R10L600-OFP1HB	260 x 215 x 35 mm	263 x 200 mm	75 x 75 mm
R10L600-OFP1TR	260 x 215 x 35 mm	263 x 200 mm	75 x 75 mm
R12L600-OFM2	300 x 250 x 40 mm	235 x 303 mm	75 x 75 mm
R12L600-OFM2HB	300 x 250 x 40 mm	235 x 303 mm	75 x 75 mm
R12L600-OFM2TR	300 x 250 x 40 mm	235 x 303 mm	75 x 75 mm
R12T600-OFL1	300 x 250 x 40 mm	235 x 303 mm	75 x 75 mm
R12T600-OFL1HB	300 x 250 x 38 mm	235 x 303 mm	75 x 75 mm
R15L100-OFA1	358 x 293 x 53 mm	275.1 x 360.6 mm	75 x 75 mm
R15L100-OFA1TR	358 x 293 x 53 mm	275.1 x 360.6 mm	75 x 75 mm
R15L100-OFA3	357.6 x 292 x 49.8 mm	275.1 x 360.6 mm	75 x 75 mm
R15L100-OFC3HB	357.6 x 292 x 49.8 mm	275.1 x 360.6 mm	75 x 75 mm
R15L600-OFC3	357.6 x 292 x 47.8 mm	275.1 x 360.6 mm	75 x 75 mm
R19L300-OFA1	445 x 355 x 56 mm	432 x 342 mm	75 x 75, 100 x 100 mm
R19L300-OFA1(HB)	445 x 355 x 55 mm	432 x 342 mm	75 x 75, 100 x 100 mm
R19L300-OFM1	445 x 355 x 56 mm	432 x 342 mm	75 x 75, 100 x 100 mm
R19L300-OFM2	445 x 355 x 56 mm	432 x 342 mm	75 x 75, 100 x 100 mm
R19L300-OFM2TR	445 x 355 x 56 mm	432 x 342 mm	75 x 75, 100 x 100 mm
R20L100-OFA2	434 x 342 x 60 mm	441.5 X 345 mm	75 x 75, 100 x 100 mm
S17L500-OFA1HB	410 x 312 x 58 mm	395 X 315 mm	75 x 75 mm
S17L500-OFA1TR	410 x 312 x 58 mm	395 X 315 mm	75 x 75 mm
S17L500-OFM1	410 x 330 x 58 mm	395 X 315 mm	75 x 75 mm
W07T700-OFA4	190 x 138 x 34.3 mm	193 x 128.6 mm	75 x 75 mm
W07T700-OF01HB	139.6 x 176 x 33 mm	193 x 128.6 mm	75 x 75 mm
W10L100-OFH1	237 x 174 x 30 mm	240 x 163 mm	75 x 75 mm
W10L100-OFH1HB	237 x 174.30 x 30 mm	240 x 163 mm	75 x 75 mm
W12L100-OFM9	280 x 206 x 35 mm	283 x 191 mm	75 x 75 mm
W12L100-OFM9HB	280 x 206 x 35 mm	283 x 191 mm	75 x 75 mm
W15L100-OFA2	366.3 x 248 x 40 mm	369.3 x 234 mm	75 x 75, 100 x 100 mm
W15L100-OFA2HB	366.3 x 248 x 40 mm	369.3 x 234 mm	75 x 75, 100 x 100 mm
W18L100-OFA2	451 x 278 x 48 mm	437.8 x 265 mm	75 x 75 mm
W18L100-OFA2HB	451.4 x 278 x 48 mm	437.8 x 265 mm	75 x 75 mm
W18L100-OFA3HB	451.4 x 278 x 48 mm	437.8 x 265 mm	75 x 75 mm
W22L100-OFA3	504 x 318 x 60 mm	507 x 303 mm	75 x 75, 100 x 100 mm

Model Name	Dimensions	Cutout	VESA
	(W x H x D, mm)	(W x H, mm)	(W x H, mm)
W22L100-OFA3HB	504 x 318 x 60 mm	507 x 303 mm	75 x 75, 100 x 100 mm
W24L100-OFA2	576.4 x 343.6 x 58 mm	561.4 x 325.6 mm	75 x 75, 100 x 100, 200 x 100 mm
W24L100-OFA2HB	576.4 x 343.6 x 58 mm	561.4 x 325.6 mm	75 x 75, 100 x 100, 200 x 100 mm
W24L100-OFA2TR	576 x 343 x 58 mm	561.4 x 325.6 mm	75 x 75, 100 x 100, 200 x 100 mm
W24L100-OFS1	570 x 375 x 58 mm	555 x 360.6 mm	75 x 75, 100 x 100, 200 x 100 mm
W27L100-OFA1	688.8 x 427 x 56 mm	638.2 x 376.4 mm	75 x 75, 100 x 100, 200 x 100 mm
W28L100-OFA2	734 x 252 x 51 mm	737 x 235 mm	N/A
W32L300-OFA3	810 x 499.4 x 68 mm	777 x 466.4 mm	75 x 75, 100 x 100, 200 x 100 mm
W32L300-OFA3HB	810 x 499.4 x 68 mm	777 x 466.4 mm	75 x 75, 100 x 100, 200 x 100 mm
W32L300-OFA3TR	810 x 499.4 x 68 mm	777 x 466.4 mm	75 x 75, 100 x 100, 200 x 100 mm
W38L100-OFA1	954 x 308 x 66 mm	928.8 x 282 mm	200 x 200, 400 x 200 mm
W42L300-OFA3	1024 x 617.20 x 68 mm	965 x 557.8 mm	75 x 75, 100 x 100, 200 x 100 mm
W42L300-OFA3HB	1024.2 x 617.2 x 68 mm	965 x 557.8 mm	75 x 75, 100 x 100, 200 x 100 mm

Product Mechanical Drawing

Unit: W x H x D, mm

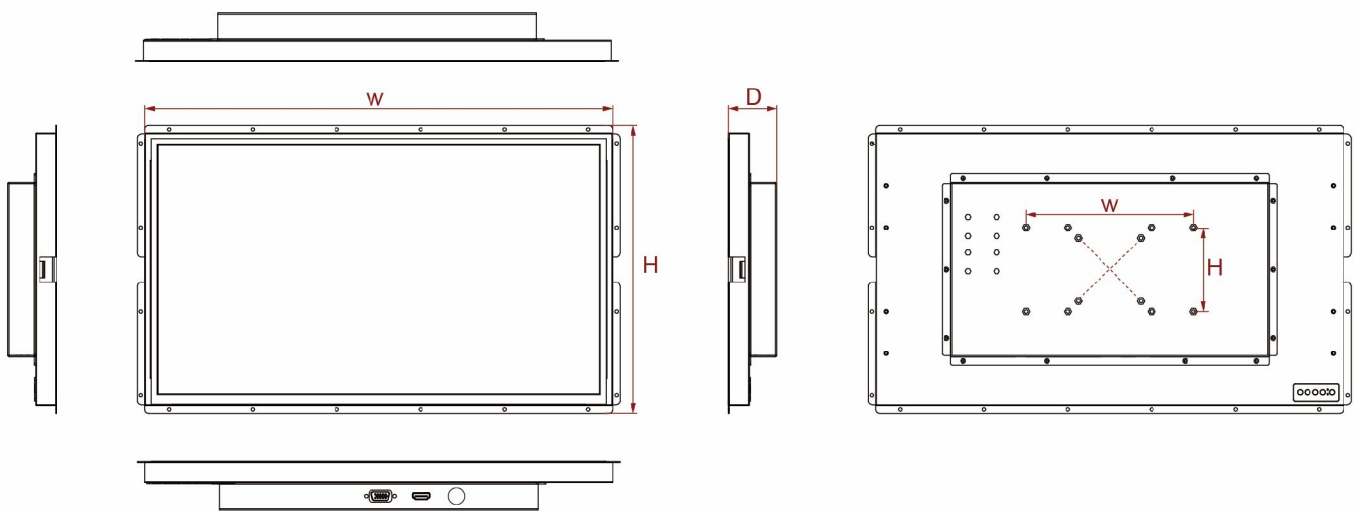

Cutout

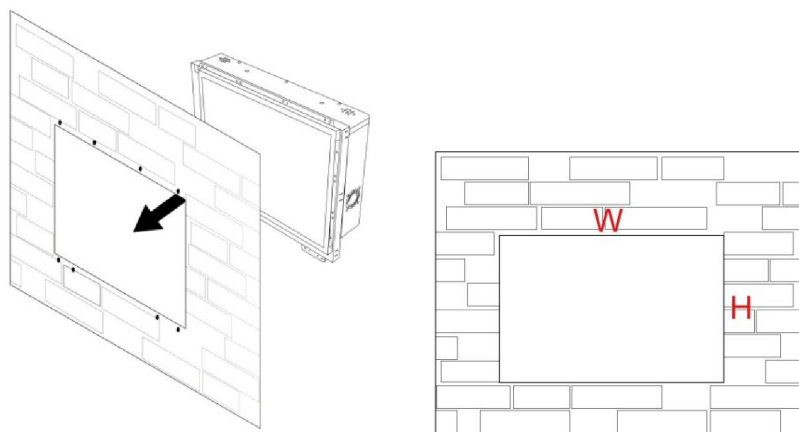

Winmate Inc.
9F, No.111-6, Shing-De Rd., San-Chung District,
New Taipei City 24158, Taiwan, R.O.C
www.winmate.com

Copyright © Winmate Inc. All rights reserved.

