



IEI Technology Corp.



MODEL:

# uIBX-210-CV-N2600 Series

Fanless Embedded System with Intel® Atom™ N2600  
DC 1.6GHz, Intel® NM10 chipset, Pre-installed 2GB DDR3  
memory, VGA, HDMI, GbE, Four USB 2.0,  
Three COM and RoHS Compliant

## User Manual

Rev. 1.01 – 28 February 2013



# Revision

---

| Date             | Version | Changes                          |
|------------------|---------|----------------------------------|
| 28 February 2013 | 1.01    | Update Section 2.3: Packing List |
| 27 December 2012 | 1.00    | Initial release                  |

# Copyright

---

## COPYRIGHT NOTICE

The information in this document is subject to change without prior notice in order to improve reliability, design and function and does not represent a commitment on the part of the manufacturer.

In no event will the manufacturer be liable for direct, indirect, special, incidental, or consequential damages arising out of the use or inability to use the product or documentation, even if advised of the possibility of such damages.

This document contains proprietary information protected by copyright. All rights are reserved. No part of this manual may be reproduced by any mechanical, electronic, or other means in any form without prior written permission of the manufacturer.

## TRADEMARKS

All registered trademarks and product names mentioned herein are used for identification purposes only and may be trademarks and/or registered trademarks of their respective owners.

# Table of Contents

---

|   |           |
|---|-----------|
| <b>1 INTRODUCTION.....</b>                              | <b>1</b>  |
| 1.1 OVERVIEW.....                                       | 2         |
| 1.2 MODEL VARIATIONS .....                              | 2         |
| 1.3 FEATURES.....                                       | 3         |
| 1.4 TECHNICAL SPECIFICATIONS .....                      | 3         |
| 1.5 FRONT PANEL.....                                    | 5         |
| 1.6 REAR PANEL.....                                     | 5         |
| 1.7 DIMENSIONS.....                                     | 7         |
| <b>2 UNPACKING .....</b>                                | <b>8</b>  |
| 2.1 ANTI-STATIC PRECAUTIONS .....                       | 9         |
| 2.2 UNPACKING PRECAUTIONS.....                          | 9         |
| 2.3 PACKING LIST.....                                   | 10        |
| <b>3 INSTALLATION .....</b>                             | <b>11</b> |
| 3.1 INSTALLATION PRECAUTIONS .....                      | 12        |
| 3.2 INSTALLATION AND CONFIGURATION STEPS .....          | 12        |
| 3.3 WI-FI ANTENNA INSTALLATION (WI-FI MODEL ONLY) ..... | 12        |
| 3.4 AT/ATX MODE SELECTION.....                          | 13        |
| 3.4.1 AT Power Mode.....                                | 14        |
| 3.4.2 ATX Power Mode .....                              | 14        |
| 3.5 RESET THE SYSTEM .....                              | 14        |
| 3.6 POWERING ON THE SYSTEM.....                         | 15        |
| 3.7 MOUNT THE SYSTEM.....                               | 15        |
| 3.7.1 Wall Mount.....                                   | 16        |
| 3.7.2 VESA mount 75 .....                               | 18        |
| 3.7.3 VESA mount 100 .....                              | 21        |
| 3.8 EXTERNAL PERIPHERAL INTERFACE CONNECTORS.....       | 23        |
| 3.8.1 Audio Connection.....                             | 25        |
| 3.8.2 HDMI Device Connection.....                       | 26        |
| 3.8.3 LAN Connection.....                               | 27        |

|  |           |
|--|-----------|
| 3.8.4 RS-232 Serial Port Connection.....           | 28        |
| 3.8.5 RS-422/485 Serial Port Connection.....       | 29        |
| 3.8.6 USB Device Connection.....                   | 30        |
| 3.8.7 VGA Monitor Connection .....                 | 31        |
| <b>4 SYSTEM MOTHERBOARD .....</b>                  | <b>32</b> |
| 4.1 OVERVIEW.....                                  | 33        |
| 4.1.1 Layout .....                                 | 33        |
| 4.2 INTERNAL PERIPHERAL CONNECTORS .....           | 33        |
| 4.2.1 Battery Connector (BAT1).....                | 34        |
| 4.2.2 BIOS Programming Connector (SPI1).....       | 34        |
| 4.2.3 Debug port Connector (DEBUGCN1).....         | 34        |
| 4.2.4 HDD LED Connector (HDDLED1).....             | 35        |
| 4.2.5 JSATA Connector (JSATA2).....                | 35        |
| 4.2.6 Power LED Connector (PWRLED1).....           | 35        |
| 4.2.7 USB 2.0 Connector (USB4_5).....              | 36        |
| 4.2.8 SATA Connector (S_ATA1).....                 | 36        |
| 4.2.9 SATA Power Connector (CNI).....              | 36        |
| 4.3 EXTERNAL INTERFACE PANEL CONNECTORS .....      | 37        |
| 4.3.1 Audio Jack (JAUDIO1).....                    | 37        |
| 4.3.2 Ethernet Connector (LAN1).....               | 37        |
| 4.3.3 HDMI Connector (HDMI1).....                  | 38        |
| 4.3.4 Power Connector (DC_JACK1) .....             | 38        |
| 4.3.5 RS-232 Serial Ports (COM1, COM2).....        | 38        |
| 4.3.6 RS-422/485 Serial Port (COM3) .....          | 39        |
| 4.3.7 USB 2.0 Connectors (USB0_1).....             | 39        |
| 4.3.8 USB 2.0 Connector (USB23).....               | 39        |
| 4.3.9 VGA Connector (VGA1).....                    | 39        |
| 4.4 JUMPER SETTINGS .....                          | 40        |
| 4.4.1 AT/ATX Mode Select Jumper (J_AUTOPWR1) ..... | 40        |
| <b>5 SYSTEM MAINTENANCE .....</b>                  | <b>41</b> |
| 5.1 SYSTEM MAINTENANCE INTRODUCTION .....          | 42        |
| 5.2 ANTI-STATIC PRECAUTIONS .....                  | 42        |
| 5.3 TURN OFF THE POWER .....                       | 43        |

|  |           |
|--|-----------|
| 5.4 REPLACING COMPONENTS.....                            | 43        |
| 5.4.1 Hard Disk Drive (HDD) Replacement.....             | 43        |
| 5.4.2 Memory Module Replacement .....                    | 46        |
| 5.4.3 WLAN Card Replacement .....                        | 47        |
| <b>6 BIOS.....</b>                                       | <b>50</b> |
| 6.1 INTRODUCTION.....                                    | 51        |
| 6.1.1 Starting Setup.....                                | 51        |
| 6.1.2 Using Setup .....                                  | 51        |
| 6.1.3 Getting Help.....                                  | 52        |
| 6.1.4 Unable to Reboot after Configuration Changes ..... | 52        |
| 6.1.5 BIOS Menu Bar.....                                 | 52        |
| 6.2 MAIN.....  | 53        |
| 6.3 ADVANCED.....  | 54        |
| 6.3.1 ACPI Configuration.....                            | 54        |
| 6.3.2 RTC Wake Settings .....                            | 55        |
| 6.3.3 CPU Configuration.....                             | 57        |
| 6.3.4 SATA Configuration .....                           | 58        |
| 6.3.5 USB Configuration.....                             | 59        |
| 6.3.6 F81866 Super IO Configuration.....                 | 60        |
| 6.3.6.1 Serial Port n Configuration.....                 | 61        |
| 6.3.7 F81866 H/W Monitor.....                            | 64        |
| 6.3.8 Serial Port Console Redirection .....              | 65        |
| 6.3.8.1 Console Redirection Settings.....                | 66        |
| 6.4 iEi FEATURE.....                                     | 68        |
| 6.5 CHIPSET .....  | 69        |
| 6.5.1 Host Bridge Configuration .....                    | 70        |
| 6.5.1.1 Intel IGD Configuration.....                     | 70        |
| 6.5.2 Southbridge Configuration .....                    | 71        |
| 6.6 BOOT.....  | 72        |
| 6.7 SECURITY.....  | 75        |
| 6.7.1 HDD Security Configuration.....                    | 76        |
| 6.8 SAVE & EXIT .....                                    | 77        |
| <b>7 SOFTWARE DRIVERS .....</b>                          | <b>79</b> |

|   |            |
|---|------------|
| 7.1 AVAILABLE SOFTWARE DRIVERS .....                                  | 80         |
| 7.2 STARTING THE DRIVER PROGRAM .....                                 | 80         |
| 7.3 CHIPSET DRIVER INSTALLATION.....                                  | 81         |
| 7.4 GRAPHIC DRIVER INSTALLATION.....                                  | 85         |
| 7.5 LAN DRIVER INSTALLATION .....                                     | 88         |
| 7.6 AUDIO DRIVER INSTALLATION .....                                   | 92         |
| <b>A SAFETY PRECAUTIONS .....</b>                                     | <b>95</b>  |
| A.1 SAFETY PRECAUTIONS .....  | 96         |
| <i>A.1.1 General Safety Precautions</i> .....                         | 96         |
| <i>A.1.2 Anti-static Precautions</i> .....                            | 97         |
| <i>A.1.3 Product Disposal</i> .....                                   | 98         |
| A.2 MAINTENANCE AND CLEANING PRECAUTIONS .....                        | 98         |
| <i>A.2.1 Maintenance and Cleaning</i> .....                           | 98         |
| <i>A.2.2 Cleaning Tools</i> .....                                     | 99         |
| <b>B BIOS MENU OPTIONS .....</b>                                      | <b>100</b> |
| <b>C ONE KEY RECOVERY .....</b>                                       | <b>103</b> |
| C.1 ONE KEY RECOVERY INTRODUCTION .....                               | 104        |
| <i>C.1.1 System Requirement</i> .....                                 | 105        |
| <i>C.1.2 Supported Operating System</i> .....                         | 106        |
| C.2 SETUP PROCEDURE FOR WINDOWS .....                                 | 107        |
| <i>C.2.1 Hardware and BIOS Setup</i> .....                            | 108        |
| <i>C.2.2 Create Partitions</i> .....                                  | 108        |
| <i>C.2.3 Install Operating System, Drivers and Applications</i> ..... | 112        |
| <i>C.2.4 Building the Recovery Partition</i> .....                    | 113        |
| <i>C.2.5 Create Factory Default Image</i> .....                       | 115        |
| C.3 AUTO RECOVERY SETUP PROCEDURE .....                               | 120        |
| C.4 SETUP PROCEDURE FOR LINUX .....                                   | 125        |
| C.5 RECOVERY TOOL FUNCTIONS .....                                     | 128        |
| <i>C.5.1 Factory Restore</i> .....                                    | 129        |
| <i>C.5.2 Backup System</i> .....                                      | 130        |
| <i>C.5.3 Restore Your Last Backup</i> .....                           | 131        |
| <i>C.5.4 Manual</i> .....   | 132        |
| C.6 RESTORE SYSTEMS FROM A LINUX SERVER THROUGH LAN .....             | 133        |

|   |     |
|---|-----|
| <i>C.6.1 Configure DHCP Server Settings</i> .....   | 134 |
| <i>C.6.2 Configure TFTP Settings</i> .....  | 135 |
| <i>C.6.3 Configure One Key Recovery Server Settings</i> .....   | 136 |
| <i>C.6.4 Start the DHCP, TFTP and HTTP</i> .....  | 137 |
| <i>C.6.5 Create Shared Directory</i> .....  | 137 |
| <i>C.6.6 Setup a Client System for Auto Recovery</i> .....  | 138 |
| <b>C.7 OTHER INFORMATION</b> .....  | 141 |
| <i>C.7.1 Using AHCI Mode or ALi M5283 / VIA VT6421A Controller</i> .....  | 141 |
| <i>C.7.2 System Memory Requirement</i> .....  | 143 |
| <b>D WATCHDOG TIMER</b> .....   | 144 |
| <b>E HAZARDOUS MATERIALS DISCLOSURE</b> .....   | 147 |
| <b>E.1 HAZARDOUS MATERIALS DISCLOSURE TABLE FOR IPB PRODUCTS CERTIFIED AS ROHS COMPLIANT UNDER 2002/95/EC WITHOUT MERCURY</b> ..... | 148 |



# List of Figures

---

|   |    |
|---|----|
| Figure 1-1: uIBX-210-CV-N2600.....                    | 2  |
| Figure 1-2: uIBX-210-CV-N2600 Front Panel.....        | 5  |
| Figure 1-3: uIBX-210-CV-N2600 Rear Panel.....         | 6  |
| Figure 1-4: Physical Dimensions (mm).....             | 7  |
| Figure 3-1: Wi-Fi Antenna Installation.....           | 13 |
| Figure 3-2: AT/ATX Switch Location.....               | 13 |
| Figure 3-3: Reset Button Location.....                | 15 |
| Figure 3-4: Power Button Location.....                | 15 |
| Figure 3-5: Wall-mounting Bracket.....                | 16 |
| Figure 3-6: Chassis Support Screws.....               | 17 |
| Figure 3-7: Secure the uIBX-210-CV-N2600.....         | 18 |
| Figure 3-8: Panel PC (VESA 75 mm).....                | 18 |
| Figure 3-9: Mount Kit Installation.....               | 19 |
| Figure 3-10: Slide the System.....                    | 19 |
| Figure 3-11: Mount Kit Screws.....                    | 20 |
| Figure 3-12: Stand Installation.....                  | 20 |
| Figure 3-13: Panel PC (VESA 100 mm).....              | 21 |
| Figure 3-14: 100 mm to 75 mm Adapter.....             | 21 |
| Figure 3-15: Mount Kit Installation.....              | 22 |
| Figure 3-16: Slide the System.....                    | 22 |
| Figure 3-17: Mount Kit Screws.....                    | 23 |
| Figure 3-18: Stand Installation.....                  | 23 |
| Figure 3-19: Peripheral Connectors (Front Panel)..... | 24 |
| Figure 3-20: Peripheral Connectors (Rear Panel).....  | 25 |
| Figure 3-21: Audio Connector.....                     | 26 |
| Figure 3-22: HDMI Connection.....                     | 27 |
| Figure 3-23: LAN Connection.....                      | 28 |
| Figure 3-24: DB-9 Serial Port Connector.....          | 29 |
| Figure 3-25: RS-422/485 Cable.....                    | 30 |
| Figure 3-26: USB Device Connection.....               | 30 |

|   |     |
|---|-----|
| Figure 3-27: VGA Connector .....                            | 31  |
| Figure 4-1: System Motherboard .....                        | 33  |
| Figure 5-1: Retention Screws Removal .....                  | 43  |
| Figure 5-2: HDD Bracket Retention Screws .....              | 44  |
| Figure 5-3: HDD Bracket .....                               | 44  |
| Figure 5-4: HDD Retention Screws .....                      | 45  |
| Figure 5-5: Remove the old HDD .....                        | 45  |
| Figure 5-6: uIBX-210-CV-N2600 SO-DIMM Socket Location ..... | 46  |
| Figure 5-7: DDR3 SO-DIMM Module Installation .....          | 47  |
| Figure 5-8: uIBX-210-CV-N2600 SO-DIMM Socket Location ..... | 48  |
| Figure 5-9: Removing the Antennas .....                     | 48  |
| Figure 5-10: Releasing the WLAN Card .....                  | 49  |
| Figure 5-11: Removing the WLAN card .....                   | 49  |
| Figure 7-1: Drivers .....                                   | 81  |
| Figure 7-2: Chipset Driver Screen .....                     | 82  |
| Figure 7-3: Chipset Driver Welcome Screen .....             | 82  |
| Figure 7-4: Chipset Driver License Agreement .....          | 83  |
| Figure 7-5: Chipset Driver Read Me File .....               | 84  |
| Figure 7-6: Chipset Driver Installation Finish Screen ..... | 84  |
| Figure 7-7: VGA Driver Welcome Screen .....                 | 85  |
| Figure 7-8: VGA Driver License Agreement .....              | 86  |
| Figure 7-9: VGA Driver Read Me File .....                   | 86  |
| Figure 7-10: VGA Driver Setup Operations .....              | 87  |
| Figure 7-11: VGA Driver Installation Finish Screen .....    | 88  |
| Figure 7-12: Windows Control Panel .....                    | 88  |
| Figure 7-13: System Control Panel .....                     | 89  |
| Figure 7-14: Device Manager List .....                      | 90  |
| Figure 7-15: Update Driver Software Window .....            | 91  |
| Figure 7-16: Locate Driver Files .....                      | 91  |
| Figure 7-17: LAN Driver Installation .....                  | 92  |
| Figure 7-18: LAN Driver Installation Complete .....         | 92  |
| Figure 7-19: Audio Driver Welcome Screen .....              | 93  |
| Figure 7-20: Audio Driver Installation .....                | 94  |
| Figure 7-21: Audio Driver Installation Complete .....       | 94  |
| Figure C-1: IEI One Key Recovery Tool Menu .....            | 104 |

|   |     |
|---|-----|
| Figure C-2: Launching the Recovery Tool .....                 | 109 |
| Figure C-3: Recovery Tool Setup Menu .....                    | 109 |
| Figure C-4: Command Prompt .....                              | 110 |
| Figure C-5: Partition Creation Commands.....                  | 111 |
| Figure C-6: Launching the Recovery Tool .....                 | 113 |
| Figure C-7: Manual Recovery Environment for Windows .....     | 113 |
| Figure C-8: Building the Recovery Partition.....              | 114 |
| Figure C-9: Press Any Key to Continue .....                   | 114 |
| Figure C-10: Press F3 to Boot into Recovery Mode.....         | 115 |
| Figure C-11: Recovery Tool Menu .....                         | 115 |
| Figure C-12: About Symantec Ghost Window.....                 | 116 |
| Figure C-13: Symantec Ghost Path .....                        | 116 |
| Figure C-14: Select a Local Source Drive .....                | 117 |
| Figure C-15: Select a Source Partition from Basic Drive ..... | 117 |
| Figure C-16: File Name to Copy Image to .....                 | 118 |
| Figure C-17: Compress Image.....                              | 118 |
| Figure C-18: Image Creation Confirmation .....                | 119 |
| Figure C-19: Image Creation Complete .....                    | 119 |
| Figure C-20: Image Creation Complete .....                    | 119 |
| Figure C-21: Press Any Key to Continue .....                  | 120 |
| Figure C-22: Auto Recovery Utility .....                      | 121 |
| Figure C-23: Launching the Recovery Tool .....                | 121 |
| Figure C-24: Auto Recovery Environment for Windows .....      | 121 |
| Figure C-25: Building the Auto Recovery Partition.....        | 122 |
| Figure C-26: Factory Default Image Confirmation .....         | 122 |
| Figure C-27: Image Creation Complete .....                    | 123 |
| Figure C-28: Press any key to continue .....                  | 123 |
| Figure C-29: Partitions for Linux.....                        | 125 |
| Figure C-30: Manual Recovery Environment for Linux .....      | 126 |
| Figure C-31: Access menu.lst in Linux (Text Mode).....        | 127 |
| Figure C-32: Recovery Tool Menu .....                         | 127 |
| Figure C-33: Recovery Tool Main Menu .....                    | 128 |
| Figure C-34: Restore Factory Default.....                     | 129 |
| Figure C-35: Recovery Complete Window .....                   | 130 |
| Figure C-36: Backup System.....                               | 130 |

|   |            |
|---|------------|
| <b>Figure C-37: System Backup Complete Window .....</b>         | <b>131</b> |
| <b>Figure C-38: Restore Backup .....</b>                        | <b>131</b> |
| <b>Figure C-39: Restore System Backup Complete Window .....</b> | <b>132</b> |
| <b>Figure C-40: Symantec Ghost Window .....</b>                 | <b>132</b> |

# List of Tables

|  |           |
|--|-----------|
| <b>Table 1-1: Model Variations .....</b>                                 | <b>2</b>  |
| <b>Table 1-2: Technical Specifications .....</b>                         | <b>5</b>  |
| <b>Table 2-1: Package List Contents .....</b>                            | <b>10</b> |
| <b>Table 4-1: Peripheral Interface Connectors .....</b>                  | <b>34</b> |
| <b>Table 4-2: Battery Connector Pinouts (BAT1) .....</b>                 | <b>34</b> |
| <b>Table 4-3: BIOS Programming Connector Pinouts (SPI1) .....</b>        | <b>34</b> |
| <b>Table 4-4: Debug port Connector Pinouts (DEBUGCN1).....</b>           | <b>35</b> |
| <b>Table 4-5: HDD LED Connector Pinouts (HDDLED1).....</b>               | <b>35</b> |
| <b>Table 4-6: JSATA Connector Pinouts (JSATA2) .....</b>                 | <b>35</b> |
| <b>Table 4-7: Power LED Connector Pinouts (PWRLED1) .....</b>            | <b>35</b> |
| <b>Table 4-8: USB 2.0 Connector Pinouts (USB4_5).....</b>                | <b>36</b> |
| <b>Table 4-9: SATA Connector Pinouts (S_ATA1) .....</b>                  | <b>36</b> |
| <b>Table 4-10: SATA Power Connector Pinouts (CN1) .....</b>              | <b>36</b> |
| <b>Table 4-11: Rear Panel Connectors .....</b>                           | <b>37</b> |
| <b>Table 4-12: Audio Jack Pinouts (JAUDIO1) .....</b>                    | <b>37</b> |
| <b>Table 4-13: Ethernet Connector Pinouts (LAN1) .....</b>               | <b>38</b> |
| <b>Table 4-14: HDMI Connector (HDMI1) Pinouts.....</b>                   | <b>38</b> |
| <b>Table 4-15: Power Connector Pinouts (DC_JACK1) .....</b>              | <b>38</b> |
| <b>Table 4-16: RS-232 Serial Ports Pinouts (COM1, COM2).....</b>         | <b>39</b> |
| <b>Table 4-17: RS-422/485 Serial Port Pinouts (COM3) .....</b>           | <b>39</b> |
| <b>Table 4-18: USB 2.0 Connectors Pinouts (USB0_1).....</b>              | <b>39</b> |
| <b>Table 4-19: USB 2.0 Connector Pinouts (USB2_3).....</b>               | <b>39</b> |
| <b>Table 4-20: VGA Connector Pinouts (VGA1) .....</b>                    | <b>40</b> |
| <b>Table 4-21: Jumper .....</b>  | <b>40</b> |
| <b>Table 4-22: AT/ATX Mode Select Jumper Settings (J_AUTOPWR1) .....</b> | <b>40</b> |
| <b>Table 6-1: BIOS Navigation Keys .....</b>                             | <b>52</b> |

Chapter

1

# Introduction

---

## 1.1 Overview



**Figure 1-1: uIBX-210-CV-N2600**

The uIBX-210-CV-N2600 embedded system is a fanless system with one VGA port and one HDMI port for dual display. It accepts a Intel® N2600 1.6GHz dual-core processor and supports one 204-pin 800 MHz dual-channel DDR3 SDRAM SO-DIMM module up to 2 GB. The uIBX-210-CV-N2600 supports a 2.5" SATA HDD with up to 3 Gb/s data transfer rate. Three serial ports and four external USB 2.0 ports ensure simplified connectivity to a variety of external peripheral devices.

## 1.2 Model Variations

The model variations of the uIBX-210-CV-N2600 series are listed below.

| Models                             | CPU                | Wireless         |
|------------------------------------|--------------------|------------------|
| <b>uIBX-210-CV-N2600/2GB-R10</b>   | Intel® Atom™ N2600 | N/A              |
| <b>UIBX-210W -CV-N2600/2GB-R10</b> | Intel® Atom™ N2600 | 2T2R 802.11b/g/n |

**Table 1-1: Model Variations**

### 1.3 Features

The uIBX-210-CV-N2600 features are listed below:

- Slim and compact embedded system design with Intel® 3rd Gen Atom N2600 dual-core processor , Supports DDR3 memory (System Max. 2GB)
- 12V only single voltage design, supports AT/ATX power mode selection
- Flexible VGA and HDMI with dual-display support
- Support PCIe Mini card slot
- Fully I/O with four USB, one VGA, one HDMI, three COM and audio

### 1.4 Technical Specifications

The uIBX-210-CV-N2600 technical specifications are listed in **Table 1-2**.

|                         |   |
|-------------------------|---|
| Chassis                 |   |
| Form Factor             | uIBX  |
| Color                   | Silver  |
| Dimensions              | 146.6mm x 132mm x 45.2mm                      |
| Chassis Construction    | Aluminum Alloy, ABS                           |
| Motherboard             |   |
| CPU                     | Intel® N2600 1.6GHz dual-core processor,      |
| Chipset                 | Intel® NM10                                   |
| BIOS                    | UEFI BIOS                                     |
| Memory                  | 2GB DDR3 800MHz (N2600 supports up to 2GB)    |
| Chipset Graphics Engine | Intel® GMA 3600, 400 MHz core speed for N2600 |
| Expansion               | 1 x PCIe Mini card slot                       |
| Audio                   | Realtek ALC662 HD Audio codec                 |
| Storage                 |   |
| SATA                    | 1 x 2.5" SATA HDD                             |



| System Function     |  |
|---------------------|--|
| Display Output      | Support HDMI, VGA for dual independent display<br>Display 1: Analog CRT up to 1920x1200 for Cedarview-D and Cedarview-M, support CRT hot plug<br>Display 2: HDMI up to 1920 x 1200 |
| Ethernet            | 1 x RJ-45 LAN by Realtek RTL8111E GbE  |
| Super I/O           | Fintek F81866  |
| Indicators          | HDD LED / Power LED indicator  |
| Front I/Os          | 1 x HDMI<br>1 x VGA<br>2 x USB port<br>1 x Mic-in<br>1 x Line-out,   |
| Rear I/Os           | 2 x USB port<br>2 x RS-232 (COM 1, COM 2)<br>1 x RS-422/485 (COM 3)<br>1 x RJ-45 LAN   |
| Interior Expansions | 1 x PCIe Mini slot (reserved for Wi-Fi)  |
| Button & Switch     | Reset switch<br>AT/ATX switch<br>Power Button  |
| Power               |  |
| Power Supply        | AT/ATX support<br>DC IN:12V/5A<br>Locking type DC-in jack on board (rear side)   |
| Power Consumption   | +12V @ 1.57A (Intel R Atom N2600 dual Core 1.6GHz , DDR3 800 2GB memory)   |
| Reliability         |  |
| Watchdog Timer      | Software programmable 1~255 sec. system reset  |

## uIBX-210-CV-N2600 Embedded System

|                       |  |
|-----------------------|--|
| Hardware Monitor      | Fintek F81865  |
| Operating Temperature | 0°C ~ 50°C with air flow   |
| Mounting              | VESA 75  |
| EMC/Safety            | CE, FCC class A  |
| Supported OS          | Microsoft® WES7E<br>Microsoft® Windows® XP Embedded<br>Microsoft® CE 6.0 |

**Table 1-2: Technical Specifications**

### 1.5 Front Panel

The front panel of the uIBX-210-CV-N2600 has the following features (**Figure 1-2**):

- 2 x RS-232 serial port connectors (COM1, COM2)
- 1 x RS-422/485 serial port connector (COM3)
- 1 x RJ-45 LAN connector
- 2 x USB 2.0 connectors

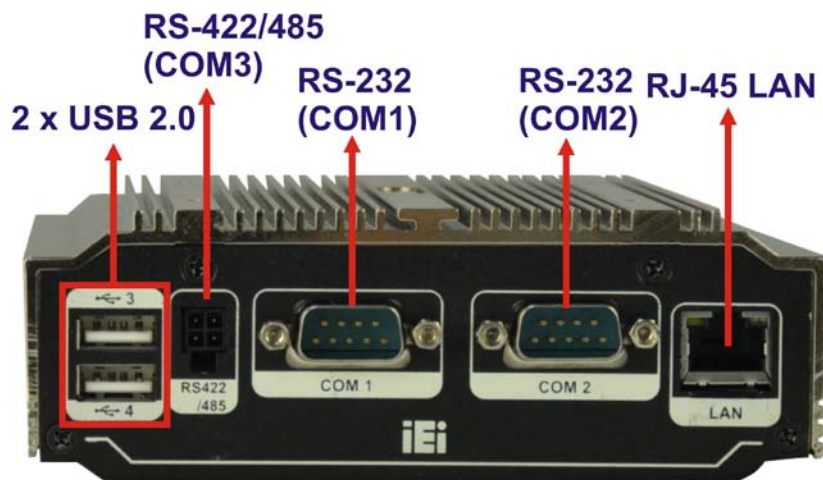

**Figure 1-2: uIBX-210-CV-N2600 Front Panel**

### 1.6 Rear Panel

The rear panel of the uIBX-210-CV-N2600 has the following features (**Figure 1-3**):

- 2 x Antenna connectors

- 1 x AT/ATX Switch
- 1 x HDD LED
- 1 x HDMI port
- 1 x Line out
- 1 x Mic
- 1 x Power button
- 1 x Power LED
- 1 x Reset button
- 2 x USB 2.0 connectors
- 1 x 12 V DC IN
- 1 x VGA port

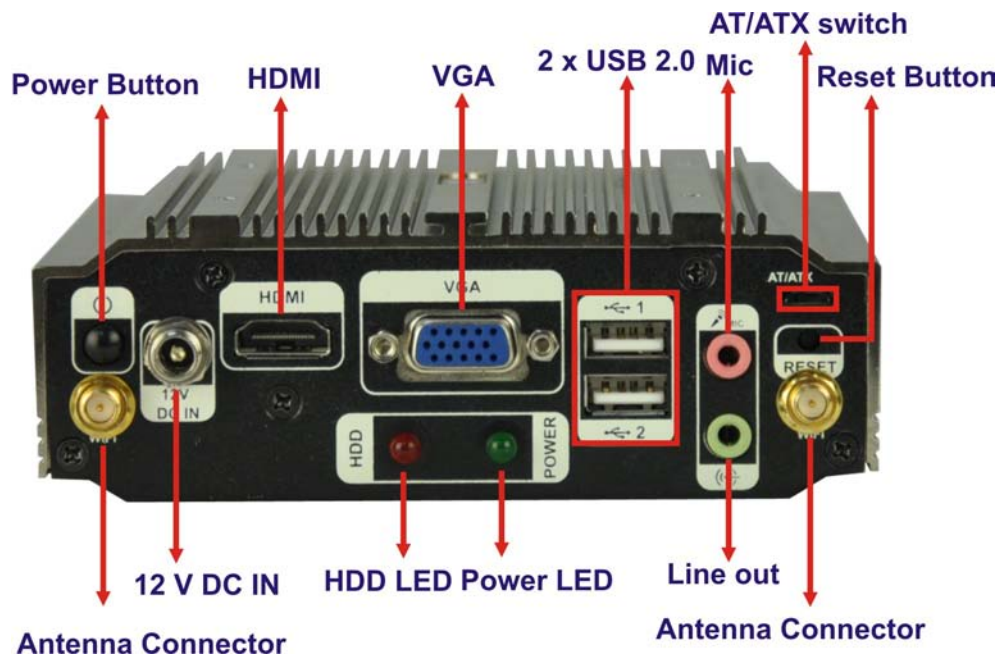

Figure 1-3: uIBX-210-CV-N2600 Rear Panel

## 1.7 Dimensions

The physical dimensions are shown below:

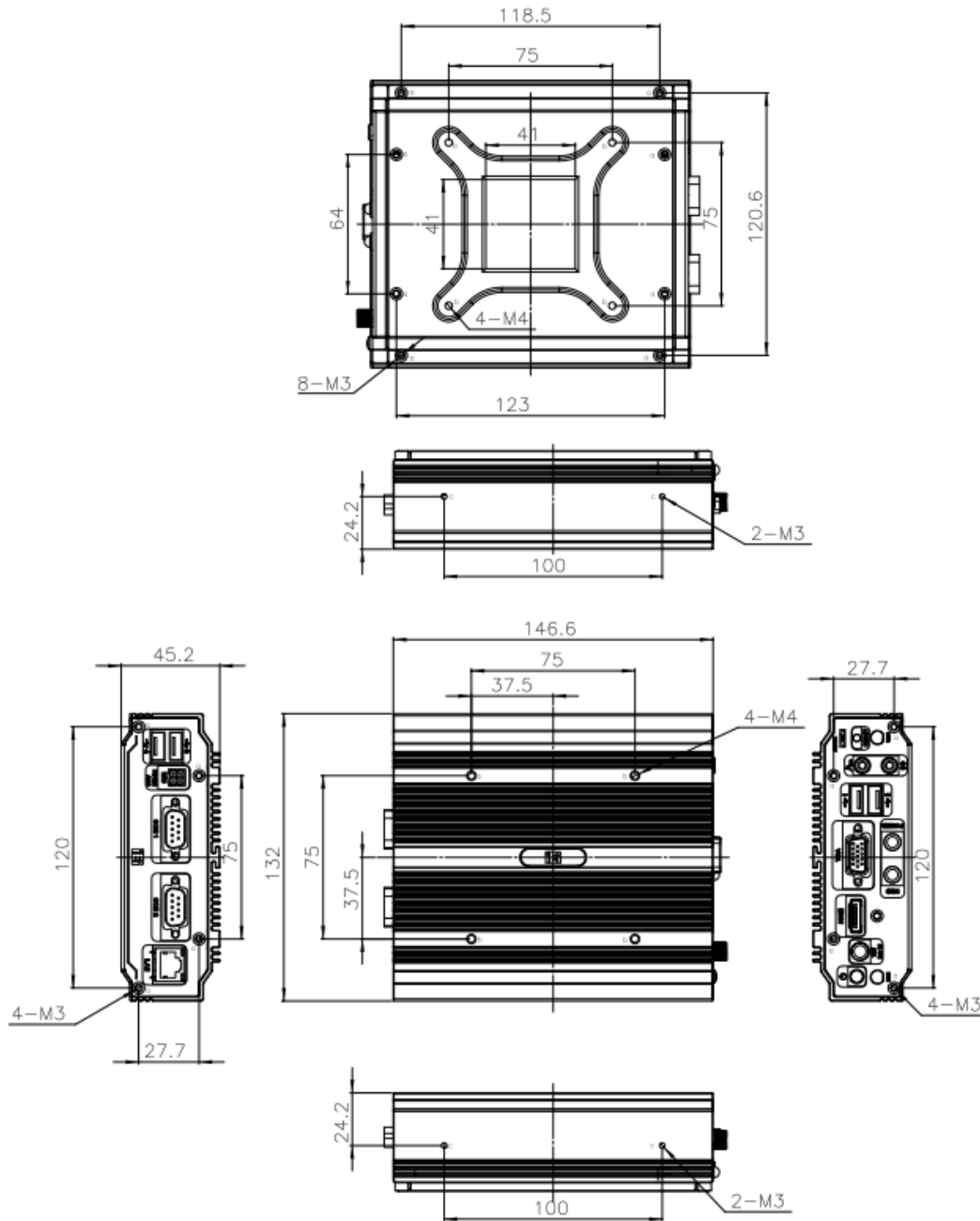

Figure 1-4: Physical Dimensions (mm)

Chapter

2

# Unpacking

---

## 2.1 Anti-static Precautions

---



### WARNING:

Failure to take ESD precautions during installation may result in permanent damage to the uIBX-210-CV-N2600 and severe injury to the user.

---

Electrostatic discharge (ESD) can cause serious damage to electronic components, including the uIBX-210-CV-N2600. Dry climates are especially susceptible to ESD. It is therefore critical that whenever the uIBX-210-CV-N2600 or any other electrical component is handled, the following anti-static precautions are strictly adhered to.

- **Wear an anti-static wristband:** Wearing a simple anti-static wristband can help to prevent ESD from damaging the board.
- **Self-grounding:** Before handling the board, touch any grounded conducting material. During the time the board is handled, frequently touch any conducting materials that are connected to the ground.
- **Use an anti-static pad:** When configuring the uIBX-210-CV-N2600, place it on an anti-static pad. This reduces the possibility of ESD damaging the uIBX-210-CV-N2600.

## 2.2 Unpacking Precautions

When the uIBX-210-CV-N2600 is unpacked, please do the following:

- Follow the anti-static precautions outlined in **Section 2.1**.
- Make sure the packing box is facing upwards so the uIBX-210-CV-N2600 does not fall out of the box.
- Make sure all the components shown in **Section 2.3** are present.





## 2.3 Packing List



### NOTE:

If some of the components listed in the checklist below are missing, please do not proceed with the installation. Contact the IEI reseller or vendor you purchased the uIBX-210-CV-N2600 from or contact an IEI sales representative directly. To contact an IEI sales representative, please send an email to [sales@iei.com.tw](mailto:sales@iei.com.tw).

The uIBX-210-CV-N2600 is shipped with the following components:

| Quantity | Item and Part Number | Image  |
|----------|----------------------|--|
| 1        | uIBX-210-CV-N2600    |   |
| 1        | 1 x Adaptor 12V/5A   |  |
| 1        | 1 x Screw set        |  |
| 1        | Utility CD           |  |
| 1        | One Key Recovery CD  |  |

**Table 2-1: Package List Contents**

Chapter

3

# Installation

---



### 3.1 Installation Precautions

During installation, be aware of the precautions below:

- **Read the user manual:** The user manual provides a complete description of the uIBX-210-CV-N2600, installation instructions and configuration options.
- **DANGER! Disconnect Power:** Power to the uIBX-210-CV-N2600 must be disconnected during the installation process, or before any attempt is made to access the rear panel. Electric shock and personal injury might occur if the rear panel of the uIBX-210-CV-N2600 is opened while the power cord is still connected to an electrical outlet.
- **Qualified Personnel:** The uIBX-210-CV-N2600 must be installed and operated only by trained and qualified personnel. Maintenance, upgrades, or repairs may only be carried out by qualified personnel who are familiar with the associated dangers.
- **Grounding:** The uIBX-210-CV-N2600 should be properly grounded. The voltage feeds must not be overloaded. Adjust the cabling and provide external overcharge protection per the electrical values indicated on the label attached to the back of the uIBX-210-CV-N2600.

### 3.2 Installation and Configuration Steps

The following installation steps must be followed.

**Step 1:** Unpack the uIBX-210-CV-N2600.

**Step 2:** Configure the system.

**Step 3:** Connect peripheral devices to the uIBX-210-CV-N2600.

**Step 4:** Mount the uIBX-210-CV-N2600.

### 3.3 Wi-Fi Antenna Installation (Wi-Fi Model Only)

To install the Wi-Fi antennas to the uIBX-210-CV-N2600 series for efficient wireless network transmission, follow the steps below.

**Step 1:** Locate the antenna connectors on the rear panel of the embedded system.

**Step 2:** Install the antennas to the antenna connectors (**Figure 3-1**).



**Figure 3-1: Wi-Fi Antenna Installation**

### 3.4 AT/ATX Mode Selection

AT or ATX power mode can be used on the uIBX-210-CV-N2600. The selection is made through an AT/ATX switch located on the rear panel (**Figure 3-2**). To select AT mode or ATX mode, follow the steps below.

**Step 1:** Locate the AT/ATX switch on the rear panel (**Figure 3-2**).



**Figure 3-2: AT/ATX Switch Location**

**Step 2:** Adjust the AT/ATX switch.

### 3.4.1 AT Power Mode

With the AT mode selected, the power is controlled by a central power unit rather than a power switch. The uIBX-210-CV-N2600 panel PC turns on automatically when the power is connected. The AT mode benefits a production line to control multiple panel PCs from a central management center and other applications including:

- ATM
- Self-service kiosk
- Plant environment monitoring system
- Factory automation platform
- Manufacturing shop flow

### 3.4.2 ATX Power Mode

With the ATX mode selected, the uIBX-210-CV-N2600 panel PC goes in a standby mode when it is turned off. The panel PC can be easily turned on via network or a power switch in standby mode. Remote power control is perfect for advertising applications since the broadcasting time for each panel PC can be set individually and controlled remotely. Other possible application includes:

- Security surveillance
- Point-of-Sale (POS)
- Advertising terminal

## 3.5 Reset the System

The reset button enables user to reboot the system when the system is turned on. To reboot the system, follow the steps below.

**Step 1:** Locate the reset button on the rear panel (**Figure 3-3**).



**Figure 3-3: Reset Button Location**

**Step 2:** Press the reset button.

### 3.6 Powering On the System

To power on the system, follow the steps below:

**Step 1:** Press the power button on the front panel (**Figure 3-4**).

**Step 2:** Once turned on, the power LED should light up.

#### Power button



**Figure 3-4: Power Button Location**

### 3.7 Mount the System

The mounting methods are described below.

### 3.7.1 Wall Mount

To mount the embedded system onto a wall using the optional VESA 75 wall mount kit, please follow the steps below.

- Step 1:** Select the location on the wall for the wall-mounting bracket.
- Step 2:** Carefully mark the locations of the four brackets screw holes on the wall.
- Step 3:** Drill four pilot holes at the marked locations on the wall for the bracket retention screws.
- Step 4:** Align the wall-mounting bracket screw holes with the pilot holes.
- Step 5:** Secure the mounting-bracket to the wall by inserting the retention screws into the four pilot holes and tightening them (Figure 3-5).

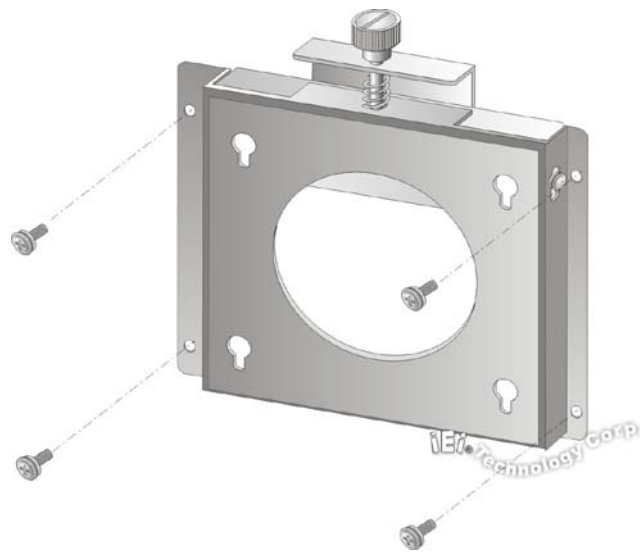
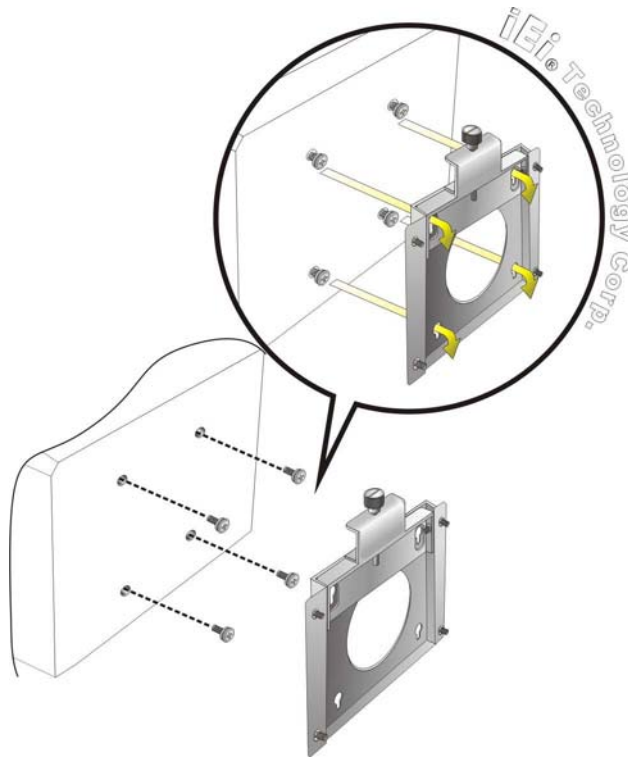

**Figure 3-5: Wall-mounting Bracket**

- Step 6:** Insert the four mounting screws provided in the package into the four screw holes on the bottom panel of the uIBX-210-CV-N2600 and tighten until the screw shank is secured against the bottom panel (Figure 3-6).
- Step 7:** Align the mounting screws on the bottom panel with the mounting holes on the bracket.

## uIBX-210-CV-N2600 Embedded System

- Step 8:** Carefully insert the screws through the holes and gently pull the system downwards until the system rests securely in the slotted holes (Figure 3-6). Ensure that all four of the mounting screws fit snugly into their respective slotted holes.



**Figure 3-6: Chassis Support Screws**

- Step 9:** Secure the uIBX-210-CV-N2600 by fastening the retention screw of the wall-mounting bracket. (Figure 3-7).



**NOTE:**

In the diagram below the bracket is already installed on the wall.

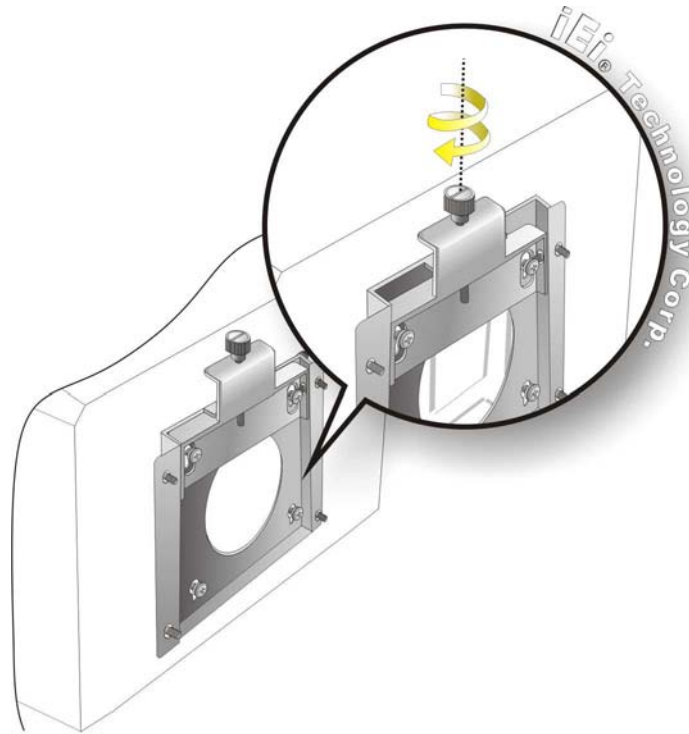

Figure 3-7: Secure the uIBX-210-CV-N2600

### 3.7.2 VESA mount 75

To mount the embedded system onto a panel PC (VESA 75 mm), please follow the steps below.

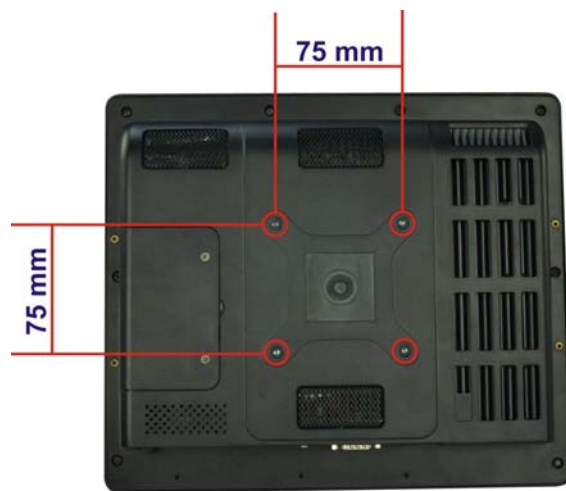

Figure 3-8: Panel PC (VESA 75 mm)

## uIBX-210-CV-N2600 Embedded System

**Step 1:** Install the mount kit on the back of the panel PC.



**Figure 3-9: Mount Kit Installation**

**Step 2:** Slide the uIBX-210-CV-N2600 into the mount kit.



**Figure 3-10: Slide the System**



Step 3: Fasten the four screws on the mount kit.



**Figure 3–11: Mount Kit Screws**

Step 4: Attach the uIBX-210-CV-N2600 to the stand using four retention screws.

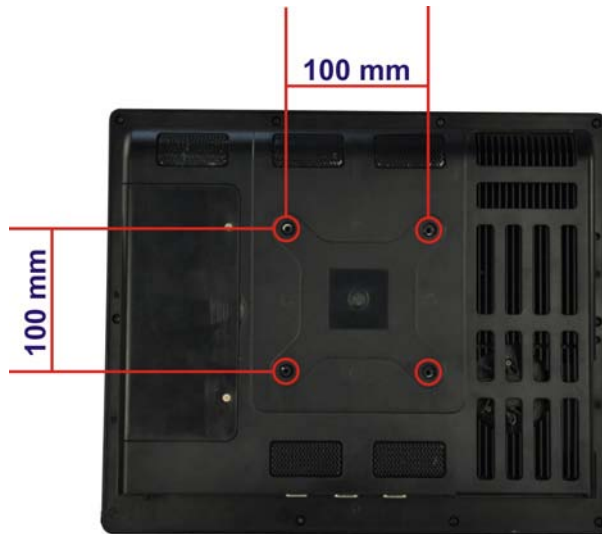

**Figure 3–12: Stand Installation**

## uIBX-210-CV-N2600 Embedded System

### 3.7.3 VESA mount 100

To mount the embedded system onto a panel PC (VESA 100 mm), please follow the steps below.



**Figure 3-13: Panel PC (VESA 100 mm)**

**Step 1:** If the mounting pattern on the panel PC is VESA 100 mm then the adapter must be attached.



**Figure 3-14: 100 mm to 75 mm Adapter**

**Step 2:** Fasten the mount kit onto the VESA mount 100 mm to 75 mm adapter on the back of the panel PC.



**Figure 3–15: Mount Kit Installation**

**Step 3:** Slide the uIBX-210-CV-N2600 into the mount kit.



**Figure 3–16: Slide the System**

## uIBX-210-CV-N2600 Embedded System

**Step 4:** Fasten the four screws on the mount kit.



**Figure 3-17: Mount Kit Screws**

**Step 5:** Attach the uIBX-210-CV-N2600 to the stand using four retention screws.



**Figure 3-18: Stand Installation**

### 3.8 External Peripheral Interface Connectors

The following external peripheral devices can be connected to the external peripheral interface connectors.

- Audio devices
- DVI devices
- HDMI devices
- RJ-45 Ethernet cable connector
- Serial devices
- USB devices

To install these devices, connect the corresponding cable connector from the actual device to the corresponding uIBX-210-CV-N2600 external peripheral interface connector making sure the pins are properly aligned.

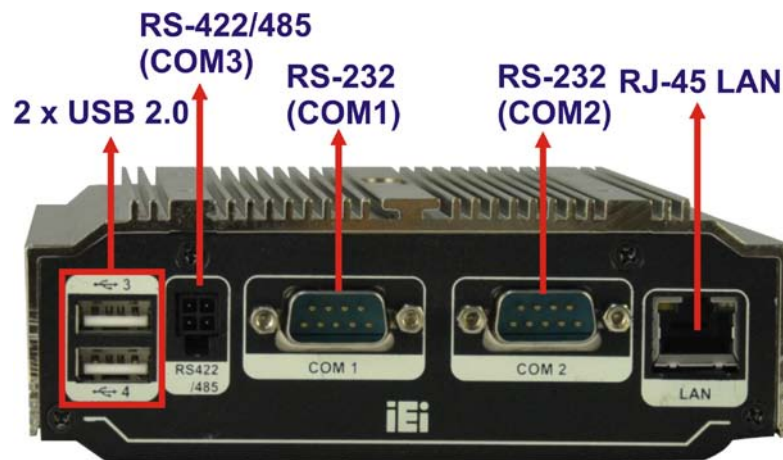

Figure 3-19: Peripheral Connectors (Front Panel)

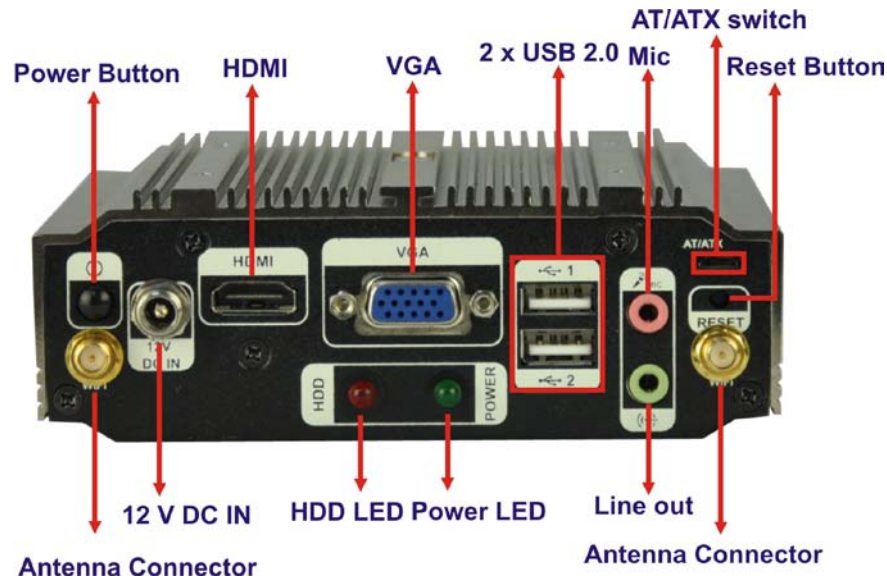

Figure 3-20: Peripheral Connectors (Rear Panel)

### 3.8.1 Audio Connection

The audio jacks on the external audio connector enable the uIBX-210-CV-N2600 to be connected to a stereo sound setup. To install the audio devices, follow the steps below.

**Step 1: Identify the audio plugs.** The plugs on your home theater system or speakers may not match the colors on the rear panel. If audio plugs are plugged into the wrong jacks, sound quality will be very bad.

**Step 2: Plug the audio plugs into the audio jacks.** Plug the audio plugs into the audio jacks. If the plugs on your speakers are different, an adapter will need to be used to plug them into the audio jacks.

- **Line Out port (Lime):** Connects to a headphone or a speaker.
- **Microphone (Pink):** Connects to a microphone.

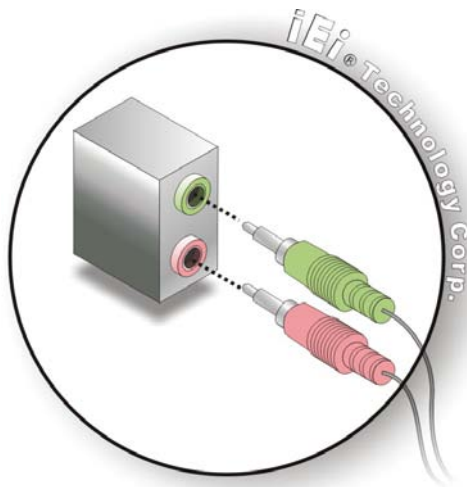

**Figure 3-21: Audio Connector**

**Step 3: Check audio clarity.** Check that the sound is coming through the right speakers by adjusting the balance front to rear and left to right.

### 3.8.2 HDMI Device Connection

The HDMI connector transmits a digital signal to compatible HDMI display devices such as a TV or computer screen. To connect the HDMI cable to the uIBX-210-CV-N2600, follow the steps below.

**Step 1: Locate the HDMI connector.** The location is shown in **Chapter 1**.

**Step 2: Align the connector.** Align the HDMI connector with the HDMI port. Make sure the orientation of the connector is correct.

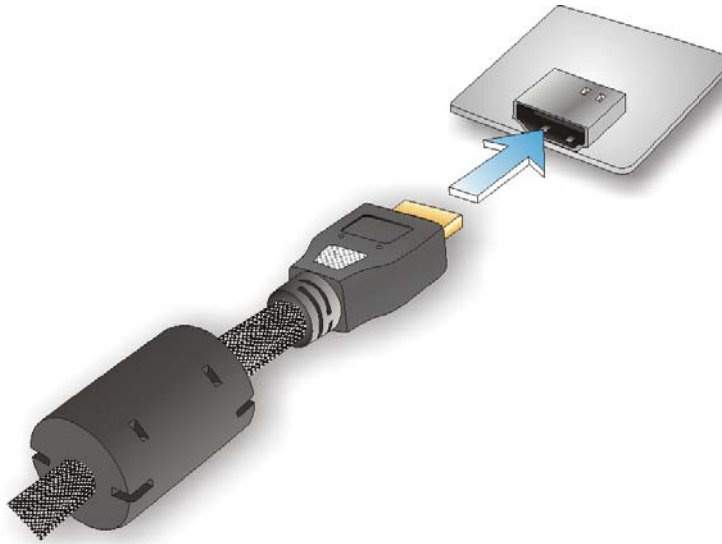

**Figure 3-22: HDMI Connection**

**Step 3: Insert the HDMI connector.** Gently insert the HDMI connector. The connector should engage with a gentle push. If the connector does not insert easily, check again that the connector is aligned correctly, and that the connector is being inserted with the right way up.

### 3.8.3 LAN Connection

There is one external RJ-45 LAN connector. The RJ-45 connector enables connection to an external network. To connect a LAN cable with an RJ-45 connector, please follow the instructions below.

**Step 1: Locate the RJ-45 connectors.** The location of the LAN connector is shown in **Chapter 1**.

**Step 2: Align the connectors.** Align the RJ-45 connector on the LAN cable with the RJ-45 connector on the uIBX-210-CV-N2600. See Figure 3-23.



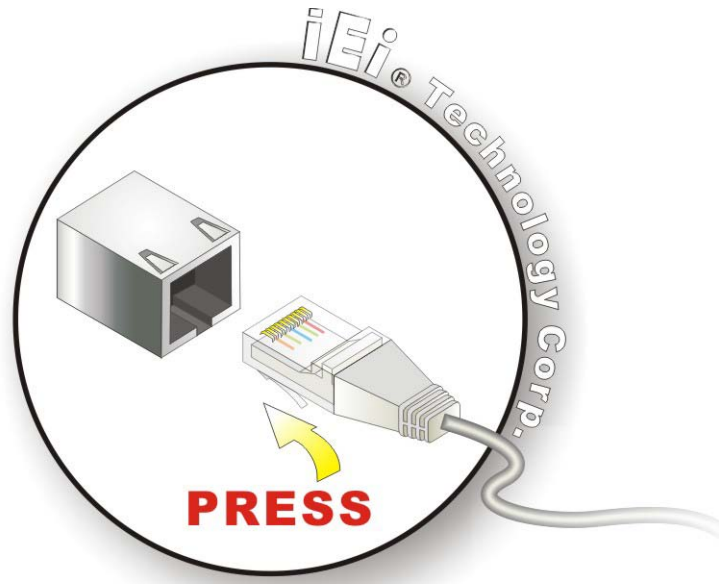

**Figure 3-23: LAN Connection**

**Step 3:** Insert the LAN cable RJ-45 connector. Once aligned, gently insert the LAN cable RJ-45 connector into the RJ-45 connector.

#### 3.8.4 RS-232 Serial Port Connection

There are two RS-232 DB-9 connectors of the uIBX-210-CV-N2600 for serial device connection. Follow the steps below to connect a serial device to the DB-9 connector of the uIBX-210-CV-N2600.

**Step 1:** Locate the DB-9 connector. The locations of the DB-9 connectors are shown in **Chapter 1**.

**Step 2:** Insert the serial connector. Insert the DB-9 connector of a serial device into the DB-9 connector on the uIBX-210-CV-N2600. See **Figure 3-24**.

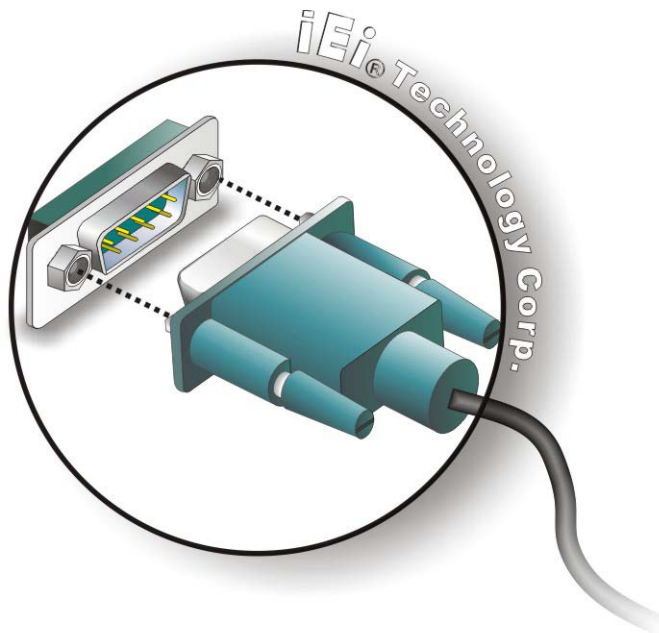

**Figure 3-24: DB-9 Serial Port Connector**

**Step 3: Secure the connector.** Secure the serial device connector to the external interface by tightening the two retention screws on either side of the connector.

### 3.8.5 RS-422/485 Serial Port Connection

There is one RS-422/485 serial port of the uIBX-210-CV-N2600 for serial device connection. Follow the steps below to connect a serial device to the RS-422/485 serial port of the uIBX-210-CV-N2600.

**Step 1:** Locate the RS-422/RS485 connector. The location of the RS-422/485 connector is shown in Figure 1-2.

**Step 2: Connect the RS-422/485 cable to the RS-422/485 connector.** The RS-422/485 cable can be bought from IEI and is shown in **Figure 3-25**.



**Figure 3-25: RS-422/485 Cable**

- Step 3: Insert the serial connector.** Insert the DB-9 connector of a serial device into the DB-9 connector on the RS-422/485 cable.
- Step 4: Secure the connector.** Secure the serial device connector to the external interface by tightening the two retention screws on either side of the connector.

### 3.8.6 USB Device Connection

There are four USB 2.0 connectors on the uIBX-210-CV-N2600. To connect a USB device, please follow the instructions below.

- Step 1: Locate the USB connectors.** The locations of the USB connectors are shown in **Chapter 1**.
- Step 2: Align the connectors.** Align the USB device connector with one of the connectors on the uIBX-210-CV-N2600. See **Figure 3-26**.

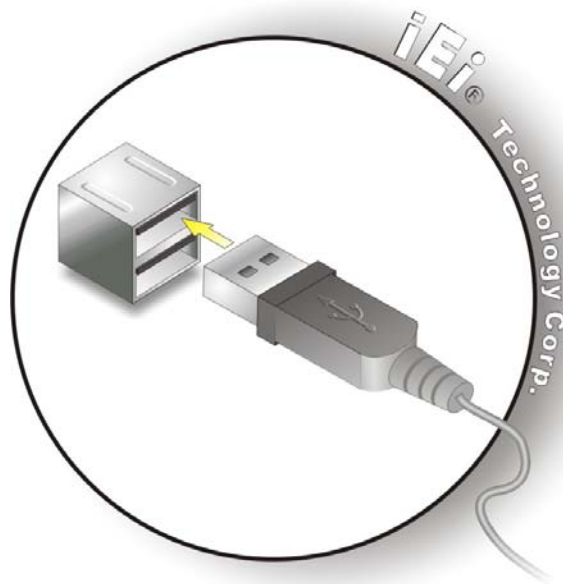

**Figure 3-26: USB Device Connection**

## uIBX-210-CV-N2600 Embedded System

**Step 3: Insert the device connector.** Once aligned, gently insert the USB device connector into the onboard connector.

### 3.8.7 VGA Monitor Connection

The uIBX-210-CV-N2600 has a single female DB-15 connector on the rear panel. The DB-15 connector is connected to a CRT or VGA monitor. To connect a monitor to the uIBX-210-CV-N2600, please follow the instructions below.

- Step 1: Locate the female DB-15 connector.** The location of the female DB-15 connector is shown in **Chapter 1**.
- Step 2: Align the VGA connector.** Align the male DB-15 connector on the VGA screen cable with the female DB-15 connector on the uIBX-210-CV-N2600.
- Step 3: Insert the VGA connector.** Once the connectors are properly aligned with the insert the male connector from the VGA screen into the female connector on the uIBX-210-CV-N2600. See **Figure 3-27**.

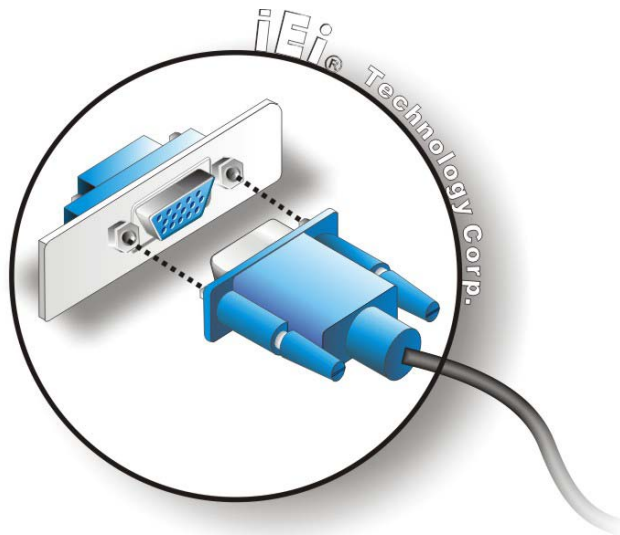

**Figure 3-27: VGA Connector**

- Step 4: Secure the connector.** Secure the DB-15 VGA connector from the VGA monitor to the external interface by tightening the two retention screws on either side of the connector.



Chapter

4

# System Motherboard

---

## 4.1 Overview

This chapter details all the jumpers and connectors of the system motherboard.

### 4.1.1 Layout

The figures below show all the connectors and jumpers of the system motherboard. The Pin 1 locations of the on-board connectors are also indicated in the diagram below.

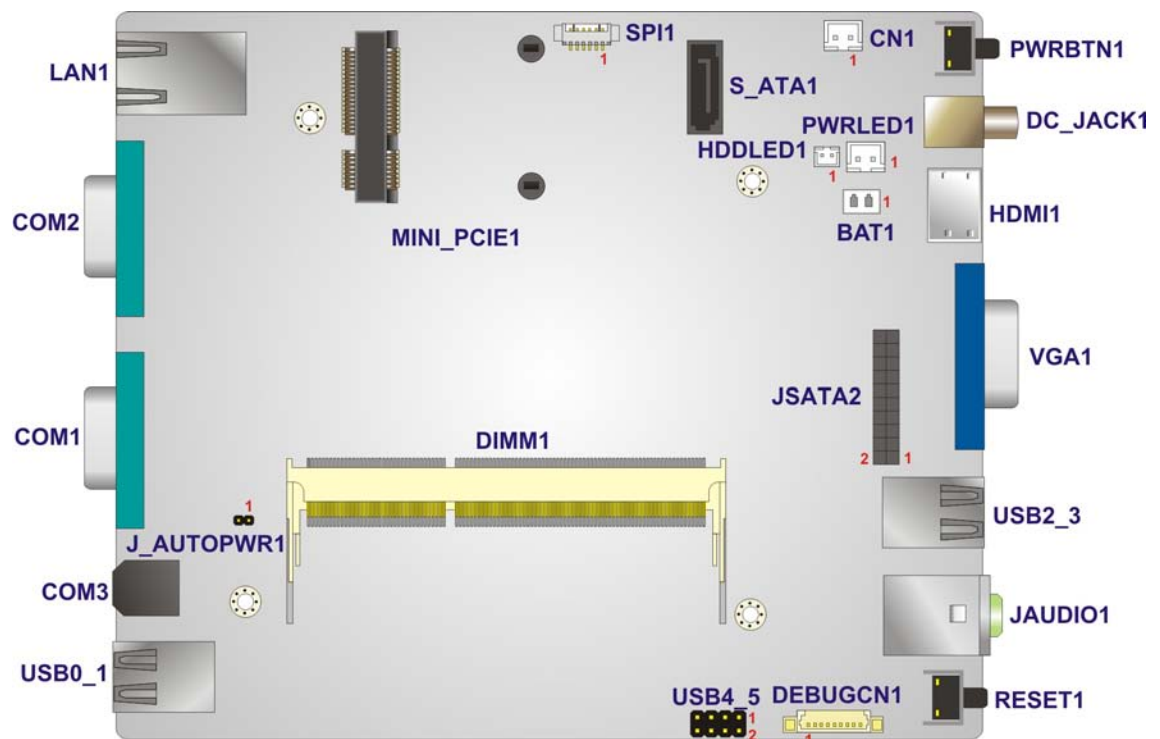

Figure 4-1: System Motherboard

## 4.2 Internal Peripheral Connectors

The table below shows a list of the internal peripheral interface connectors on the system motherboard. Pinouts of these connectors can be found in the following sections.

| Connector                  | Type        | Label |
|----------------------------|-------------|-------|
| Battery connector          | 2-pin wafer | BAT1  |
| BIOS programming connector | 6-pin wafer | SPI1  |

| Connector                  | Type                 | Label      |
|----------------------------|----------------------|------------|
| DDR3 SO-DIMM slot          | DDR3 SO-DIMM slot    | DIMM1      |
| Debug port connector       | 9-pin wafer          | DEBUGCN1   |
| HDD LED connector          | 2-pin wafer          | HDDLED1    |
| JSATA connector            | 20-pin connector     | JSATA2     |
| PCIe Mini Card Slot        | PCIe mini card slot  | MINI_PCIE1 |
| Power LED connector        | 2-pin wafer          | PWRLED1    |
| USB 2.0 connector          | 8-pin header         | USB4_5     |
| SATA 3Gb/s drive connector | 7-pin SATA connector | S_ATA1     |
| SATA power connector       | 2-pin wafer          | CN1        |

**Table 4-1: Peripheral Interface Connectors**

#### 4.2.1 Battery Connector (BAT1)

| PIN NO. | DESCRIPTION |
|---------|-------------|
| 1       | VBATT       |
| 2       | GND         |

**Table 4-2: Battery Connector Pinouts (BAT1)**

#### 4.2.2 BIOS Programming Connector (SPI1)

| PIN NO. | DESCRIPTION | PIN NO. | DESCRIPTION |
|---------|-------------|---------|-------------|
| 1       | +SPI_VCC    | 2       | SPI_CS#0_CN |
| 3       | SPI_S00_CN  | 4       | SPI_CLK0_CN |
| 5       | SPI_S10_CN  | 6       | GND         |

**Table 4-3: BIOS Programming Connector Pinouts (SPI1)**

#### 4.2.3 Debug port Connector (DEBUGCN1)

| PIN NO. | DESCRIPTION | PIN NO. | DESCRIPTION   |
|---------|-------------|---------|---------------|
| 1       | PLT_RST#    | 2       | LPC_DEBUG_CLK |
| 3       | GND         | 4       | LPC_AD3       |

|   |         |   |            |
|---|---------|---|------------|
| 5 | LPC_AD2 | 6 | LPC_AD1    |
| 7 | LPC_ADO | 8 | LPC_FRAME# |
| 9 | +3.3V   |   |            |

**Table 4-4: Debug port Connector Pinouts (DEBUGCN1)**

#### 4.2.4 HDD LED Connector (HDDLED1)

| PIN NO. | DESCRIPTION |
|---------|-------------|
| 1       | SATA_LED#   |
| 2       | +5V         |

**Table 4-5: HDD LED Connector Pinouts (HDDLED1)**

#### 4.2.5 JSATA Connector (JSATA2)

| PIN NO. | DESCRIPTION | PIN NO. | DESCRIPTION |
|---------|-------------|---------|-------------|
| 1       | GND         | 2       | +12V        |
| 3       | N/C         | 4       | +12V        |
| 5       | N/C         | 6       | N/C         |
| 7       | GND         | 8       | +5V         |
| 9       | SATA_RX1+   | 10      | +5V         |
| 11      | SATA_RX1-   | 12      | +5V         |
| 13      | GND         | 14      | +5V         |
| 15      | SATA_TX1-   | 16      | GND         |
| 17      | SATA_TX1+   | 18      | +3V         |
| 19      | GND         | 20      | +3V         |

**Table 4-6: JSATA Connector Pinouts (JSATA2)**

#### 4.2.6 Power LED Connector (PWRLED1)

| PIN NO. | DESCRIPTION | PIN NO. | DESCRIPTION |
|---------|-------------|---------|-------------|
| 1       | GND         | 2       | +5V         |

**Table 4-7: Power LED Connector Pinouts (PWRLED1)**



#### 4.2.7 USB 2.0 Connector (USB4\_5)

| PIN NO. | DESCRIPTION | PIN NO. | DESCRIPTION |
|---------|-------------|---------|-------------|
| 1       | +5V         | 2       | GND         |
| 3       | USB_PN5     | 4       | USB_PP6     |
| 5       | USB_PP5     | 6       | USB_PN6     |
| 7       | GND         | 8       | +5V         |

**Table 4-8: USB 2.0 Connector Pinouts (USB4\_5)**

#### 4.2.8 SATA Connector (S\_ATA1)

| PIN NO. | DESCRIPTION |
|---------|-------------|
| 1       | GND         |
| 2       | SATA_TX0+   |
| 3       | SATA_TX0-   |
| 4       | GND         |
| 5       | SATA_RX0-   |
| 6       | SATA_RX0+   |
| 7       | GND         |

**Table 4-9: SATA Connector Pinouts (S\_ATA1)**

#### 4.2.9 SATA Power Connector (CN1)

| PIN NO. | DESCRIPTION |
|---------|-------------|
| 1       | +5V         |
| 2       | GND         |

**Table 4-10: SATA Power Connector Pinouts (CN1)**

### 4.3 External Interface Panel Connectors

The table below shows a list of the external interface panel connectors on the system motherboard. Pinouts of these connectors can be found in the following sections.

| Connector                     | Type            | Label             |
|-------------------------------|-----------------|-------------------|
| Audio jack (mic-in, line-out) | Audio jack      | JAUDIO1           |
| Ethernet connector            | RJ-45           | LAN1              |
| HDMI connector                | HDMI            | HDMI1             |
| Power connector               | Power jack      | DC_JACK1          |
| RS-232 serial ports           | DB-9            | COM1, COM2        |
| RS-422/485 serial port        | 4-pin connector | COM3              |
| USB 2.0 connectors            | USB 2.0 port    | USB0_1,<br>USB2_3 |
| VGA connector                 | DB-15           | VGA1              |

**Table 4-11: Rear Panel Connectors**

#### 4.3.1 Audio Jack (JAUDIO1)

| PIN NO. | DESCRIPTION  | PIN NO. | DESCRIPTION  |
|---------|--------------|---------|--------------|
| 1       | GND_AUDIO    | 2       | LMIC1-CONN-L |
| 3       | GND_AUDIO    | 4       | JD_MIC       |
| 5       | LMIC1-CONN-R | 22      | LFRONT-L     |
| 23      | GND_AUDIO    | 24      | JD_FRONT     |
| 25      | LFRONT-R     |         |              |

**Table 4-12: Audio Jack Pinouts (JAUDIO1)**

#### 4.3.2 Ethernet Connector (LAN1)

| PIN NO. | DESCRIPTION | PIN NO. | DESCRIPTION |
|---------|-------------|---------|-------------|
| 1       | MDIO+       | 2       | MDIO-       |
| 3       | MDI1+       | 4       | MDI1-       |
| 5       | GND         | 6       | GND         |

|    |         |    |             |
|----|---------|----|-------------|
| 7  | MDI2+   | 8  | MDI2-       |
| 9  | MDI3+   | 10 | MDI3-       |
| 11 | LINK100 | 12 | LINK1000    |
| 13 | ACT     | 14 | +V3.3A_LAN1 |
| 15 | GND     | 16 | GND         |

**Table 4-13: Ethernet Connector Pinouts (LAN1)**

#### 4.3.3 HDMI Connector (HDMI1)

| PIN NO. | DESCRIPTION | PIN NO. | DESCRIPTION |
|---------|-------------|---------|-------------|
| 1       | HDMI_DATA2  | 2       | GND         |
| 3       | HDMI_DATA2# | 4       | HDMI_DATA1  |
| 5       | GND         | 6       | HDMI_DATA1# |
| 7       | HDMI_DATA0  | 8       | GND         |
| 9       | HDMI_DATA0# | 10      | HDMI_CLK    |
| 11      | GND         | 12      | HDMI_CLK#   |
| 13      | NC          | 14      | NC          |
| 15      | HDMI_SCL    | 16      | HDMI_SDA    |
| 17      | GND         | 18      | +5V         |
| 19      | HDMI_HPD    |         |             |

**Table 4-14: HDMI Connector (HDMI1) Pinouts**

#### 4.3.4 Power Connector (DC\_JACK1)

| PIN NO. | DESCRIPTION | PIN NO. | DESCRIPTION |
|---------|-------------|---------|-------------|
| 1       | VCC12V      | 2       | GND         |
| 3       | GND         |         |             |

**Table 4-15: Power Connector Pinouts (DC\_JACK1)**

#### 4.3.5 RS-232 Serial Ports (COM1, COM2)

| PIN NO. | DESCRIPTION | PIN NO. | DESCRIPTION |
|---------|-------------|---------|-------------|
| 1       | NDCD1/2     | 2       | NRXD1/2     |
| 3       | NTXD1/2     | 4       | NDTR1/2     |

|   |         |    |         |
|---|---------|----|---------|
| 5 | GND     | 6  | NDSR1/2 |
| 7 | NRTS1/2 | 8  | NCTS1/2 |
| 9 | NRI1/2  | 10 |         |

**Table 4-16: RS-232 Serial Ports Pinouts (COM1, COM2)**

#### 4.3.6 RS-422/485 Serial Port (COM3)

| PIN NO. | DESCRIPTION | PIN NO. | DESCRIPTION |
|---------|-------------|---------|-------------|
| 1       | RXD485+     | 2       | RXD485#     |
| 3       | TXD485+     | 4       | TXD485#     |

**Table 4-17: RS-422/485 Serial Port Pinouts (COM3)**

#### 4.3.7 USB 2.0 Connectors (USB0\_1)

| PIN NO. | DESCRIPTION | PIN NO. | DESCRIPTION |
|---------|-------------|---------|-------------|
| 1       | +5V         | 2       | USB_PN0     |
| 3       | USB_PP0     | 4       | GND         |
| 5       | +5V         | 6       | USB_PN1     |
| 7       | USB_PP1     | 8       | GND         |

**Table 4-18: USB 2.0 Connectors Pinouts (USB0\_1)**

#### 4.3.8 USB 2.0 Connector (USB23)

| PIN NO. | DESCRIPTION | PIN NO. | DESCRIPTION |
|---------|-------------|---------|-------------|
| 1       | +5V         | 2       | USB_PN2     |
| 3       | USB_PP2     | 4       | GND         |
| 5       | +5V         | 6       | USB_PN3     |
| 7       | USB_PP3     | 8       | GND         |

**Table 4-19: USB 2.0 Connector Pinouts (USB2\_3)**

#### 4.3.9 VGA Connector (VGA1)

| PIN NO. | DESCRIPTION | PIN NO. | DESCRIPTION |
|---------|-------------|---------|-------------|
| 1       | Red         | 2       | Green       |
| 3       | Blue        | 4       | NC          |

|    |        |    |         |
|----|--------|----|---------|
| 5  | GND    | 6  | GND     |
| 7  | GND    | 8  | GND     |
| 9  | VGAVCC | 10 | HOTPLUG |
| 11 | NC     | 12 | DDCDAT  |
| 13 | HSYNC  | 14 | VSYNC   |
| 15 | DDCCLK |    |         |

**Table 4-20: VGA Connector Pinouts (VGA1)**

## 4.4 Jumper Settings

The jumpers on the system motherboard are listed in **Table 4-21**.

| Connector          | Type         | Label      |
|--------------------|--------------|------------|
| AT/ATX mode select | 2-pin header | J_AUTOPWR1 |

**Table 4-21: Jumper**

### 4.4.1 AT/ATX Mode Select Jumper (J\_AUTOPWR1)

| Pin   | Description        |
|-------|--------------------|
| Short | AT Mode            |
| Open  | ATX Mode (Default) |

**Table 4-22: AT/ATX Mode Select Jumper Settings (J\_AUTOPWR1)**

Chapter

5

# System Maintenance

---

## 5.1 System Maintenance Introduction

If the components of the uIBX-210-CV-N2600 fail they must be replaced. Component that can be replaced include:

- HDD module
- SO-DIMM module
- WLAN module

Please contact the system reseller or vendor to purchase the replacement parts. Back cover removal instructions for the uIBX-210-CV-N2600 are described below.

## 5.2 Anti-static Precautions



### WARNING:

Failure to take ESD precautions during the maintenance of the uIBX-210-CV-N2600 may result in permanent damage to the uIBX-210-CV-N2600 and severe injury to the user.

---

Electrostatic discharge (ESD) can cause serious damage to electronic components, including the uIBX-210-CV-N2600. Dry climates are especially susceptible to ESD. It is therefore critical that whenever the uIBX-210-CV-N2600 is accessed internally, or any other electrical component is handled, the following anti-static precautions are strictly adhered to.

- ***Wear an anti-static wristband:*** - Wearing a simple anti-static wristband can help to prevent ESD from damaging the board.
- ***Self-grounding:*** - Before handling the board touch any grounded conducting material. During the time the board is handled, frequently touch any conducting materials that are connected to the ground.
- ***Use an anti-static pad:*** - When configuring the uIBX-210-CV-N2600, place it on an anti-static pad. This reduces the possibility of ESD damaging the uIBX-210-CV-N2600.

- **Only handle the edges of the PCB:** - When handling the PCB, hold the PCB by the edges.

## 5.3 Turn off the Power



### WARNING:

Failing to turn off the system before opening can cause permanent damage to the system and serious or fatal injury to the user.

Before any maintenance procedures are carried out on the system, make sure the system is turned off.

## 5.4 Replacing Components

### 5.4.1 Hard Disk Drive (HDD) Replacement

To replace the hard drive, please follow the steps below:

**Step 1:** Remove eight (8) retention screws from the back cover (**Figure 5-1**).



**Figure 5-1: Retention Screws Removal**

**Step 2:** Remove the back cover and locate the HDD bracket (**Figure 5-2**).



**Step 3:** Remove the four HDD bracket retention screws and disconnect the SATA connector (JSATA2), as shown in **Figure 5-2**.



**Figure 5-2: HDD Bracket Retention Screws**

**Step 4:** Lift the HDD bracket out of the uIBX-210-CV-N2600 (**Figure 5-3**).



**Figure 5-3: HDD Bracket**

**Step 5:** Remove the four HDD retention screws (**Figure 5-4**).



**Figure 5-4: HDD Retention Screws**

**Step 6:** Remove the old HDD from the HDD bracket (**Figure 5-5**).



**Figure 5-5: Remove the old HDD**

**Step 7:** Slide the new HDD to the HDD bracket. Secure the HDD with the HDD bracket by four HDD retention screws.

**Step 8:** Correctly align the four retention screw holes on the HDD bracket with the retention screw holes on the chassis. Insert four previously removed retention screws to secure the HDD bracket to the chassis.

**Step 9:** Connect the SATA connector (JSATA2).

**Step 10:** Replace the back cover and secure it using eight (8) previously removed retention screws.

### 5.4.2 Memory Module Replacement

If the memory module fails, follow the instructions below to replace the memory module.

**Step 1:** Remove eight (8) retention screws from the back cover. See **Section 5.4.1**.

**Step 2:** Remove HDD module. See **Section 5.4.1**.

**Step 3:** Locate the memory module indicated below.

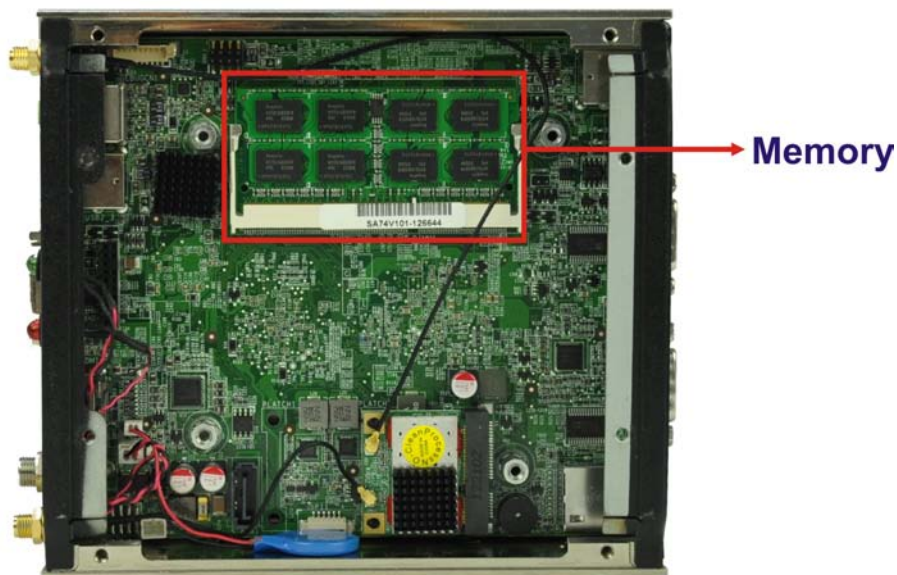

**Figure 5-6: uIBX-210-CV-N2600 SO-DIMM Socket Location**

**Step 4:** Remove the DDR3 memory module by pulling both the spring retainer clips outward from the socket.

**Step 5:** Grasp the DDR3 memory module by the edges and carefully pull it out of the socket.

**Step 6:** Install the new DDR3 memory module by pushing it into the socket at an angle (**Figure 5-7**).

## uIBX-210-CV-N2600 Embedded System

- Step 7:** Gently pull the spring retainer clips of the SO-DIMM socket out and push the rear of the DDR3 memory module down (**Figure 5-7**).
- Step 8:** Release the spring retainer clips on the SO-DIMM socket. They clip into place and secure the DDR3 memory module in the socket.

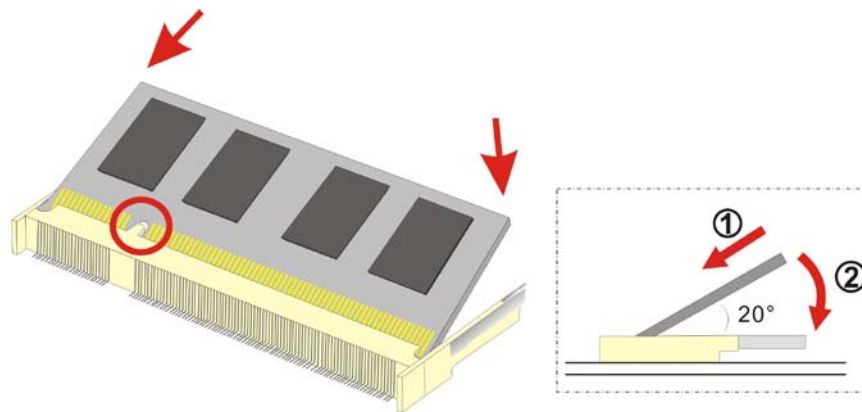

**Figure 5-7: DDR3 SO-DIMM Module Installation**

- Step 9:** Replace the back cover and secure it using eight (8) previously removed retention screws.

### 5.4.3 WLAN Card Replacement

The uIBX-210-CV-N2600 has one WLAN card slot. To replace the WLAN card, follow the instructions below.

- Step 1:** Remove eight (8) retention screws from the back cover. See **Section 5.4.1**.
- Step 2:** Remove HDD module. See **Section 5.4.1**.
- Step 3:** Locate the WLAN card.

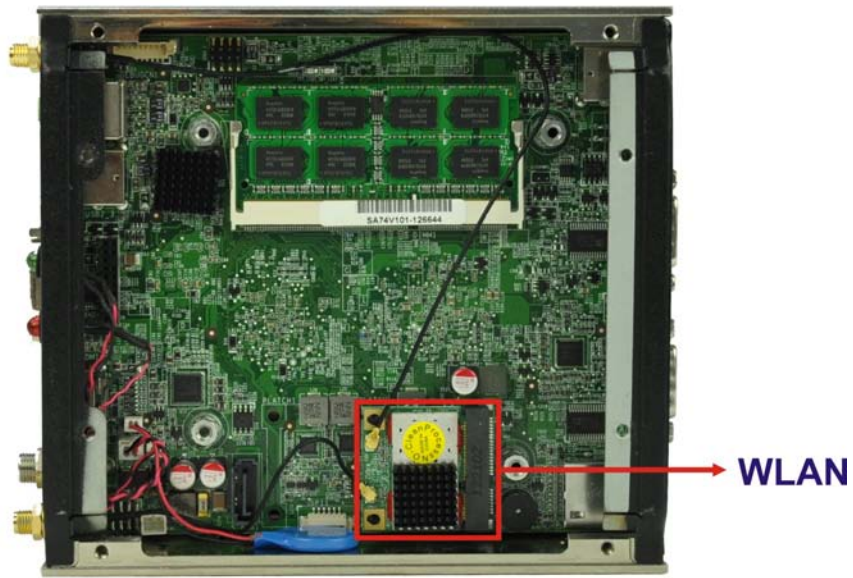

Figure 5-8: uIBX-210-CV-N2600 SO-DIMM Socket Location

Step 4: Disconnect the antenna connectors on the WLAN module (Figure 5-9).



Figure 5-9: Removing the Antennas

Step 5: Push the two spring clips in to release the WLAN card.



**Figure 5-10: Releasing the WLAN Card**

**Step 6:** Grasp the WLAN card by the edges and carefully pull it out of the socket (**Figure 5-11**).



**Figure 5-11: Removing the WLAN card**

**Step 7:** Install a new WLAN card by inserting the card into the slot at an angle

**Step 8:** Push the WLAN card down until the spring retainer clips lock into place.

**Step 9:** Connect the antenna connectors on the WLAN module.

**Step 10:** Replace the back cover and secure it using eight (8) previously removed retention screws.



Chapter

6

**BIOS**

---

## 6.1 Introduction

The BIOS is programmed onto the BIOS chip. The BIOS setup program allows changes to certain system settings. This chapter outlines the options that can be changed.

### 6.1.1 Starting Setup

The AMI BIOS is activated when the computer is turned on. The setup program can be activated in one of two ways.

1. Press the **DELETE** key as soon as the system is turned on or
2. Press the **DELETE** key when the “**Press Del to enter SETUP**” message appears on the screen.

If the message disappears before the **DELETE** key is pressed, restart the computer and try again.

### 6.1.2 Using Setup

Use the arrow keys to highlight items, press **ENTER** to select, use the PageUp and PageDown keys to change entries, press **F1** for help and press **ESC** to quit. Navigation keys are shown in.

| Key         | Function   |
|-------------|--|
| Up arrow    | Move to previous item  |
| Down arrow  | Move to next item  |
| Left arrow  | Move to the item on the left hand side   |
| Right arrow | Move to the item on the right hand side  |
| Esc key     | Main Menu – Quit and not save changes into CMOS<br>Status Page Setup Menu and Option Page Setup Menu --<br>Exit current page and return to Main Menu |
| F1 key      | General help, only for Status Page Setup Menu and Option Page Setup Menu   |
| F2 key      | Load previous values.  |
| F3 key      | Load optimized defaults  |



| Key    | Function                  |
|--------|---------------------------|
| F4 key | Save all the CMOS changes |

**Table 6-1: BIOS Navigation Keys**

### 6.1.3 Getting Help

When **F1** is pressed a small help window describing the appropriate keys to use and the possible selections for the highlighted item appears. To exit the Help Window press **Esc** or the **F1** key again.

### 6.1.4 Unable to Reboot after Configuration Changes

If the computer cannot boot after changes to the system configuration is made, CMOS defaults. Use the jumper described in Chapter 5.

### 6.1.5 BIOS Menu Bar

The **menu bar** on top of the BIOS screen has the following main items:

- Main – Changes the basic system configuration.
- Advanced – Changes the advanced system settings.
- Chipset – Changes the chipset settings.
- Boot – Changes the system boot configuration.
- Security – Sets User and Supervisor Passwords.
- Save & Exit – Selects exit options and loads default settings

The following sections completely describe the configuration options found in the menu items at the top of the BIOS screen and listed above.

## 6.2 Main

The **Main** BIOS menu (**BIOS Menu 1**) appears when the **BIOS Setup** program is entered. The **Main** menu gives an overview of the basic system information.

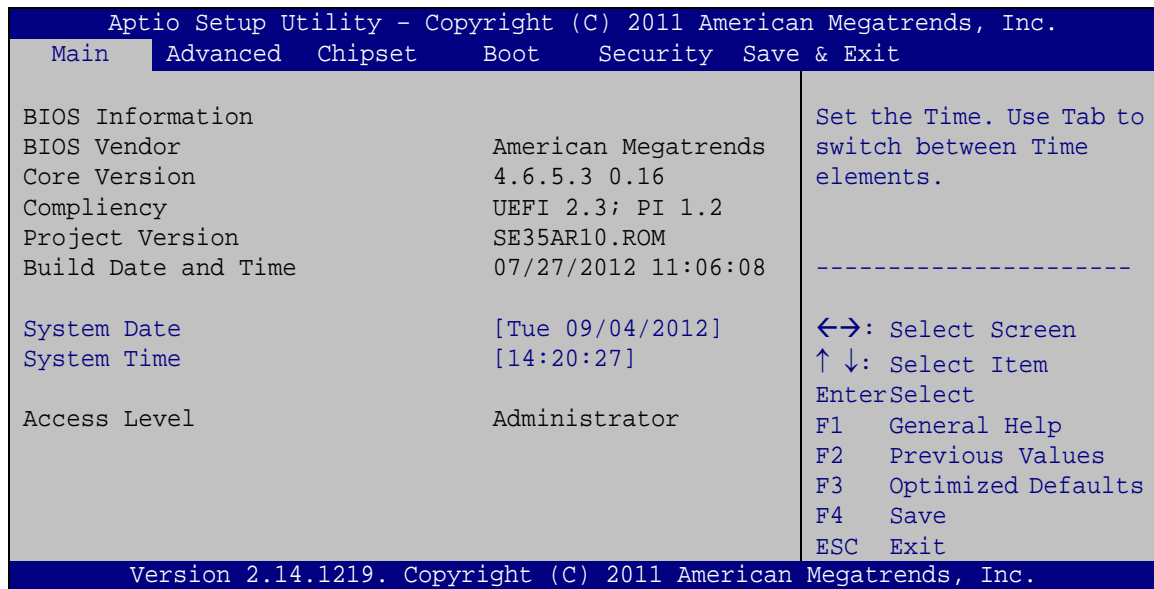

### BIOS Menu 1: Main

#### → BIOS Information

The **BIOS Information** lists a brief summary of the BIOS. The fields in **BIOS Information** cannot be changed. The items shown in the system overview include:

- **BIOS Vendor:** Installed BIOS vendor
- **Core Version:** Current BIOS version
- **Compliency:** Current compliant version
- **Project Version:** the board version
- **Build Date and Time:** Date the current BIOS version was made

The System Overview field also has two user configurable fields:

#### → System Date [xx/xx/xx]

Use the **System Date** option to set the system date. Manually enter the day, month and year.

➔ System Time [xx:xx:xx]

Use the **System Time** option to set the system time. Manually enter the hours, minutes and seconds.

## 6.3 Advanced

Use the **Advanced** menu (**BIOS Menu 2**) to configure the CPU and peripheral devices through the following sub-menus:



### WARNING!

Setting the wrong values in the sections below may cause the system to malfunction. Make sure that the settings made are compatible with the hardware.

```

Aptio Setup Utility - Copyright (C) 2009 American Megatrends, Inc.
Main  Advanced  Chipset  Boot  Security  Save & Exit
-----
> ACPI Settings
> RTC Wake Settings
> CPU Configuration
> SATA Configuration
> USB Configuration
> F81866 Super IO Configuration
> F81866 H/M Monitor
> Serial Port Console Redirection
> iEi Feature

System ACPI Parameters
-----
<->: Select Screen
↑ ↓: Select Item
Enter>Select
F1  General Help
F2  Previous Values
F3  Optimized
Defaults
F4  Save
ESC Exit

Version 2.14.1219. Copyright (C) 2011 American Megatrends, Inc.
    
```

### BIOS Menu 2: Advanced

#### 6.3.1 ACPI Configuration

The **ACPI Configuration** menu (**BIOS Menu 3**) configures the Advanced Configuration and Power Interface (ACPI) options.

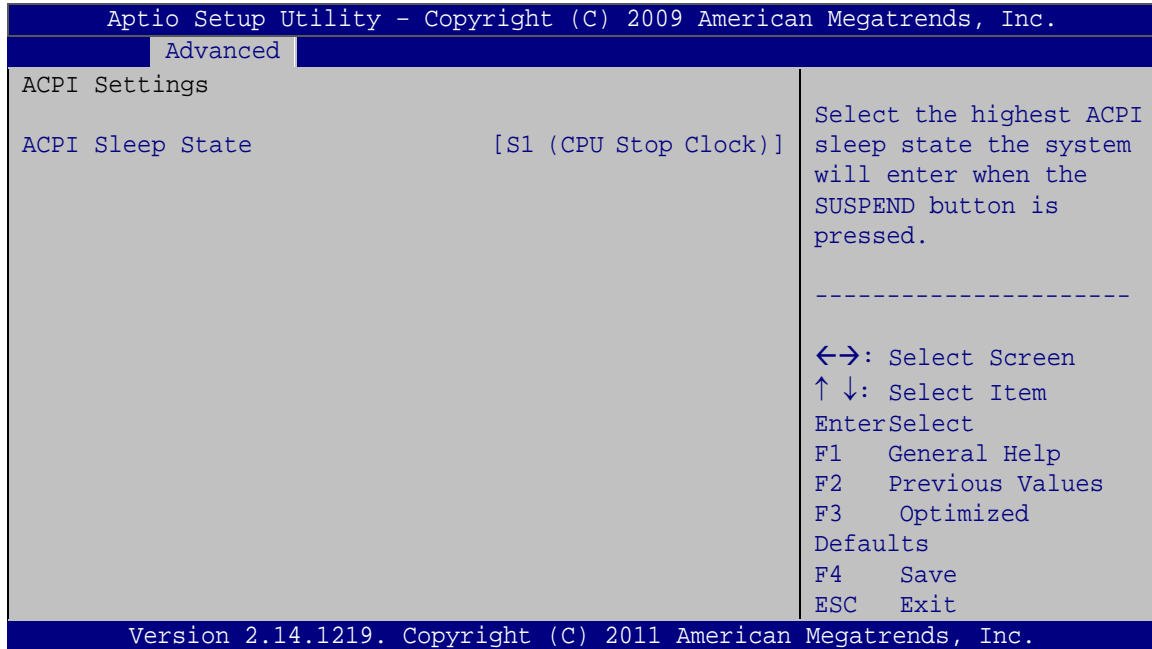

### BIOS Menu 3: ACPI Configuration

#### → ACPI Sleep State [S1 (CPU Stop Clock)]

Use the **ACPI Sleep State** option to specify the sleep state the system enters when it is not being used.

- **S1 (CPU Stop Clock)** **DEFAULT** The system enters S1 (POS) sleep state. The system appears off. The CPU is stopped; RAM is refreshed; the system is running in a low power mode.
- **S3 (Suspend to RAM)** The caches are flushed and the CPU is powered off. Power to the RAM is maintained. The computer returns slower to a working state, but more power is saved.

### 6.3.2 RTC Wake Settings

The **RTC Wake Settings** menu (**BIOS Menu 4**) configures RTC wake event.

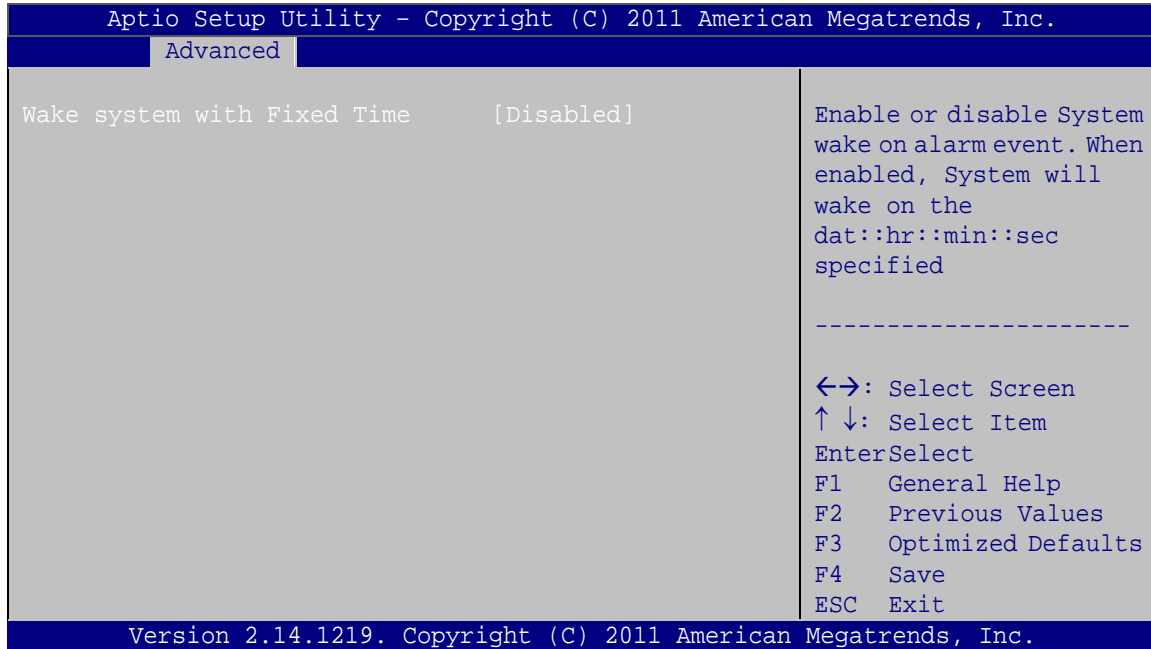

#### BIOS Menu 4: RTC Wake Settings

→ Wake system with Fixed Time [Disabled]

Use the **Wake system with Fixed Time** option to enable or disable the system wake on alarm event.

→ **Disabled**      **DEFAULT**      The real time clock (RTC) cannot generate a wake event

→ **Enabled**      If selected, the **Wake up every day** option appears allowing you to enable to disable the system to wake every day at the specified time. Besides, the following options appear with values that can be selected:

Wake up date

Wake up hour

Wake up minute

Wake up second

After setting the alarm, the computer turns itself on from a suspend state when the alarm goes off.

### 6.3.3 CPU Configuration

Use the **CPU Configuration** menu (**BIOS Menu 5**) to view detailed CPU specifications and configure the hyper-threading function.

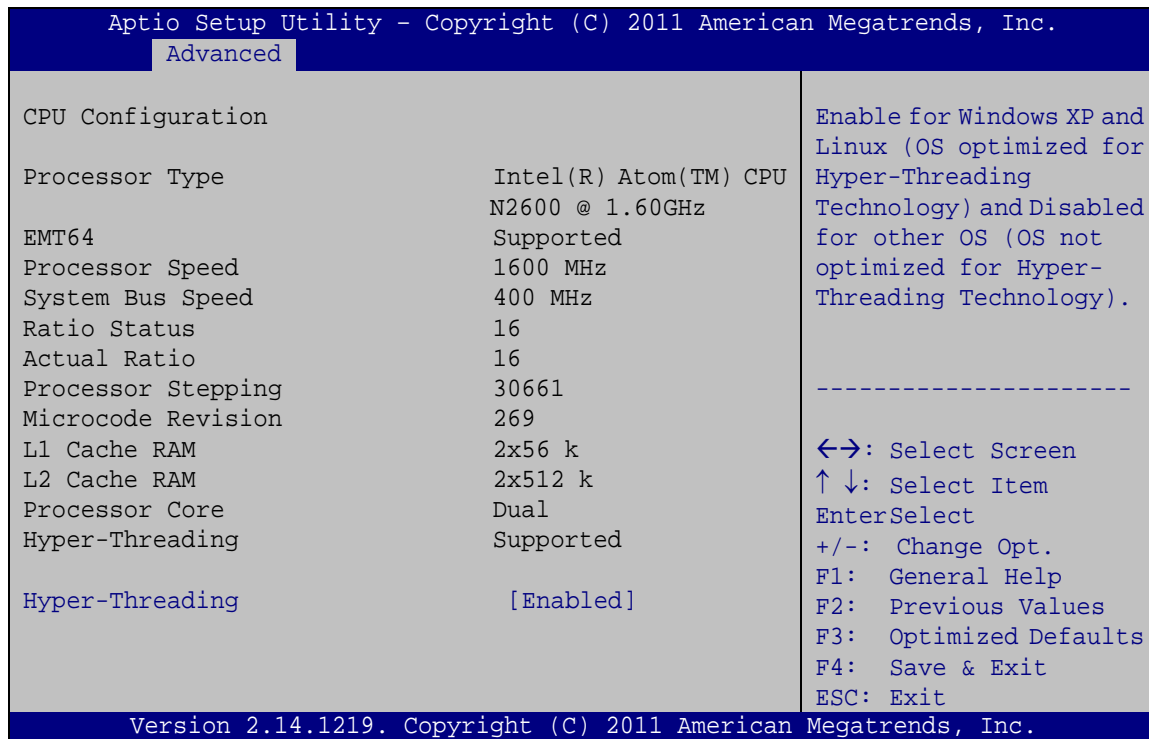

#### BIOS Menu 5: CPU Configuration

The CPU Configuration menu (**BIOS Menu 5**) lists the following CPU details:

- Processor Type: Lists the CPU processing type.
- EMT64: Indicates if EMT64 is supported by the CPU.
- Processor Speed: Lists the CPU processing speed.
- System Bus Speed: Lists the system bus speed.
- Ratio Status: Lists the ratio status.
- Actual Ratio: Lists the actual ratio.
- Processor Stepping: Lists the CPU processing stepping.
- Microcode Revision: Lists the microcode revision.
- L1 Cache RAM: Lists the L1 cache RAM size.
- L2 Cache RAM: Lists the L2 cache RAM size.
- Processor Core: Lists the number of the processor cores.

- Hyper-Threading: Indicates if hyper-threading is supported by the CPU.

➔ Hyper-Threading [Disabled]

Use the **Hyper-Threading** function to enable or disable the CPU hyper-threading function.

- ➔ **Disabled** Disables the use of hyper-threading technology
- ➔ **Enabled** **DEFAULT** Enables the use of hyper-threading technology

### 6.3.4 SATA Configuration

Use the **SATA Configuration** menu (**BIOS Menu 6**) to change and/or set the configuration of the SATA devices installed in the system.

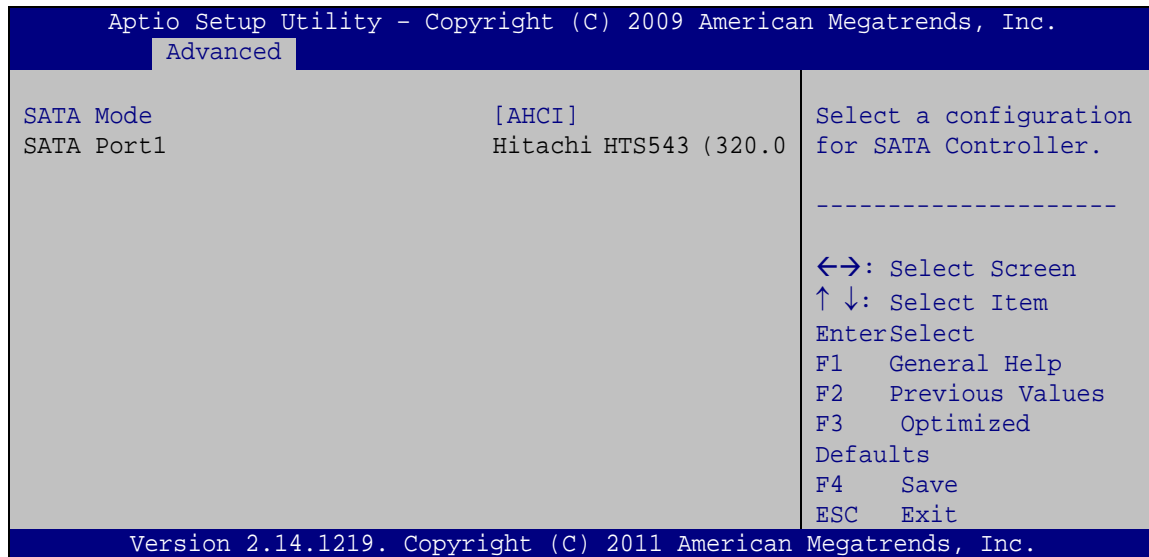

#### BIOS Menu 6: IDE Configuration

➔ SATA Mode [AHCI]

Use the **SATA Mode** option to configure SATA devices.

- ➔ **IDE** Configures SATA devices as normal IDE device.
- ➔ **AHCI** **DEFAULT** Configures SATA devices as AHCI device.

### 6.3.5 USB Configuration

Use the **USB Configuration** menu (**BIOS Menu 7**) to read USB configuration information and configure the USB settings.

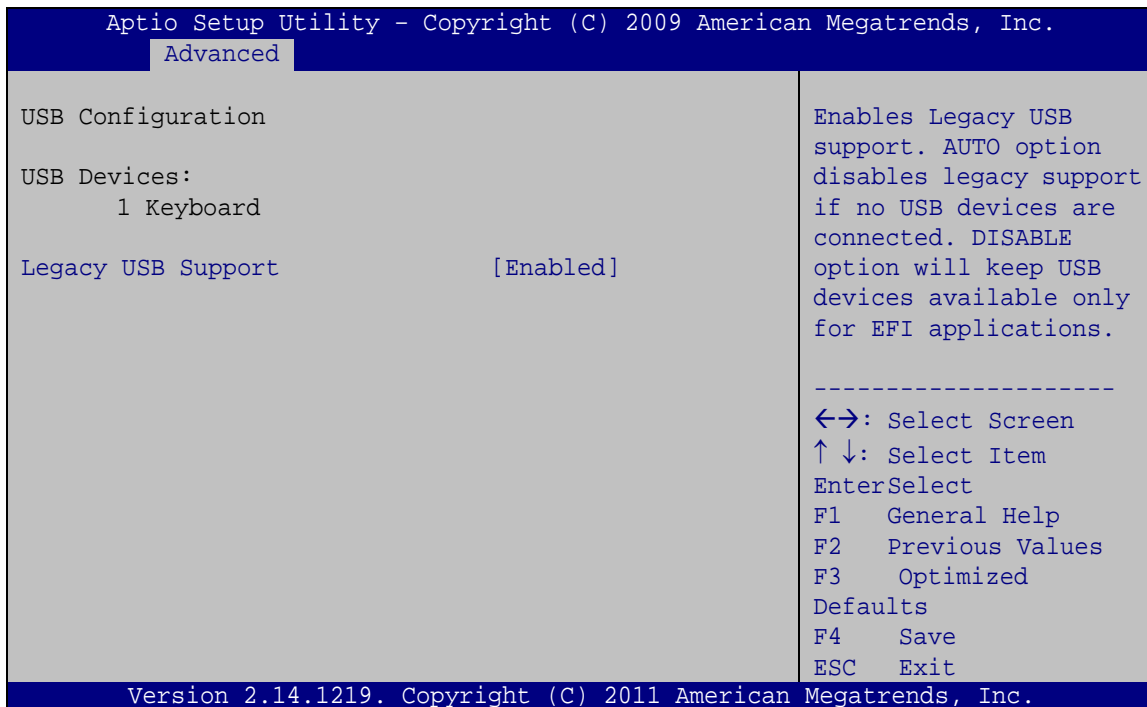

#### BIOS Menu 7: USB Configuration

##### → USB Devices

The **USB Devices Enabled** field lists the USB devices that are enabled on the system

##### → Legacy USB Support [Enabled]

Use the **Legacy USB Support** BIOS option to enable USB mouse and USB keyboard support. Normally if this option is not enabled, any attached USB mouse or USB keyboard does not become available until a USB compatible operating system is fully booted with all USB drivers loaded. When this option is enabled, any attached USB mouse or USB keyboard can control the system even when there is no USB driver loaded onto the system.

##### → Disabled

Legacy USB support disabled



- ➔ **Enabled**      **DEFAULT**      Legacy USB support enabled
- ➔ **Auto**                      Legacy USB support disabled if no USB devices are connected

### 6.3.6 F81866 Super IO Configuration

Use the **F81866 Super IO Configuration** menu (**BIOS Menu 8**) to set or change the configurations for the FDD controllers, parallel ports and serial ports.

```

Aptio Setup Utility - Copyright (C) 2009 American Megatrends, Inc.
  Advanced
F81866 Super IO Configuration
F81866 Super IO Chip                      F81866
> Serial Port 1 Configuration
> Serial Port 2 Configuration
> Serial Port 3 Configuration

Set Parameters of Serial Port 1 (COMA)
-----
<=>: Select Screen
↑↓: Select Item
Enter>Select
F1    General Help
F2    Previous Values
F3    Optimized Defaults
F4    Save
ESC   Exit

Version 2.14.1219. Copyright (C) 2011 American Megatrends, Inc.
    
```

**BIOS Menu 8: Super IO Configuration**

### 6.3.6.1 Serial Port n Configuration

Use the **Serial Port n Configuration** menu (**BIOS Menu 9**) to configure the serial port n.

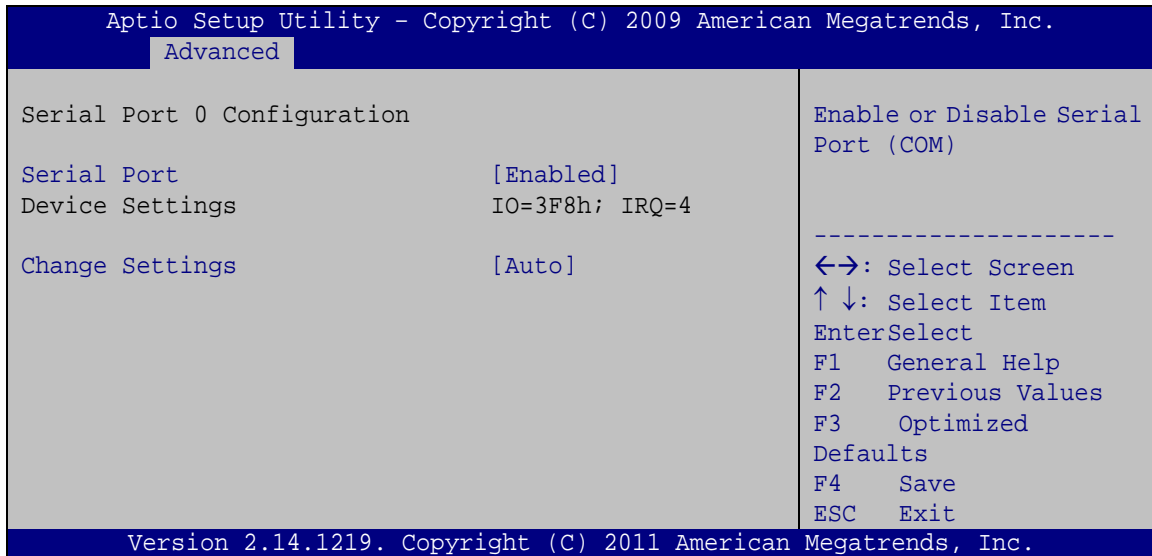

#### BIOS Menu 9: Serial Port n Configuration Menu

##### 6.3.6.1.1 Serial Port 1 Configuration

###### → Serial Port [Enabled]

Use the **Serial Port** option to enable or disable the serial port.

- **Disabled** Disable the serial port
- **Enabled** **DEFAULT** Enable the serial port

###### → Change Settings [Auto]

Use the **Change Settings** option to change the serial port IO port address and interrupt address.

- **Auto** **DEFAULT** The serial port IO port address and interrupt address are automatically detected.
- **IO=3F8h;**  
**IRQ=4** Serial Port I/O port address is 3F8h and the interrupt address is IRQ4

- ➔ **IO=3F8h;**  
**IRQ=3, 4**                      Serial Port I/O port address is 3F8h and the interrupt address is IRQ3, 4
- ➔ **IO=2F8h;**  
**IRQ=3, 4**                      Serial Port I/O port address is 2F8h and the interrupt address is IRQ3, 4
- ➔ **IO=3E8h;**  
**IRQ=3, 4**                      Serial Port I/O port address is 3E8h and the interrupt address is IRQ3, 4
- ➔ **IO=2E8h;**  
**IRQ=3, 4**                      Serial Port I/O port address is 2E8h and the interrupt address is IRQ3, 4

### 6.3.6.1.2 Serial Port 2 Configuration

#### ➔ Serial Port [Enabled]

Use the **Serial Port** option to enable or disable the serial port.

- ➔ **Disabled**                      Disable the serial port
- ➔ **Enabled**                      **DEFAULT**                      Enable the serial port

#### ➔ Change Settings [Auto]

Use the **Change Settings** option to change the serial port IO port address and interrupt address.

- ➔ **Auto**                      **DEFAULT**                      The serial port IO port address and interrupt address are automatically detected.
- ➔ **IO=2F8h;**  
**IRQ=3**                      Serial Port I/O port address is 2F8h and the interrupt address is IRQ3
- ➔ **IO=3F8h;**  
**IRQ=3, 4**                      Serial Port I/O port address is 3F8h and the interrupt address is IRQ3, 4
- ➔ **IO=2E8h;**  
**IRQ=3, 4**                      Serial Port I/O port address is 2E8h and the interrupt address is IRQ3, 4
- ➔ **IO=3E8h;**  
**IRQ=3, 4**                      Serial Port I/O port address is 3E8h and the interrupt address is IRQ3, 4

- ➔ **IO=2E8h;**                      Serial Port I/O port address is 2E8h and the interrupt  
**IRQ=3, 4**                      address is IRQ3, 4

### 6.3.6.1.3 Serial Port 3 Configuration

- ➔ Serial Port [Enabled]

Use the **Serial Port** option to enable or disable the serial port.

- ➔ **Disabled**                      Disable the serial port
- ➔ **Enabled**                      **DEFAULT**                      Enable the serial port

- ➔ Change Settings [Auto]

Use the **Change Settings** option to change the serial port IO port address and interrupt address.

- ➔ **Auto**                      **DEFAULT**                      The serial port IO port address and interrupt address are automatically detected.
- ➔ **IO=3E8h;**                      Serial Port I/O port address is 3E8h and the interrupt  
**IRQ=10**                      address is IRQ10
- ➔ **IO=3F8h;**                      Serial Port I/O port address is 3F8h and the interrupt  
**IRQ=10, 11**                      address is IRQ10, 11
- ➔ **IO=2F8h;**                      Serial Port I/O port address is 2F8h and the interrupt  
**IRQ=10, 11**                      address is IRQ10, 11
- ➔ **IO=3E8h;**                      Serial Port I/O port address is 3E8h and the interrupt  
**IRQ=10, 11**                      address is IRQ10, 11
- ➔ **IO=2E8h;**                      Serial Port I/O port address is 2E8h and the interrupt  
**IRQ=10, 11**                      address is IRQ10, 11
- ➔ **IO=250h;**                      Serial Port I/O port address is 250h and the interrupt  
**IRQ=10, 11**                      address is IRQ10, 11
- ➔ **IO=2E0h;**                      Serial Port I/O port address is 2E0h and the interrupt  
**IRQ=10, 11**                      address is IRQ10, 11

➔ Device Mode [RS422]

The **Device Mode** shows Serial Port 3 provides RS-422/485 communications.

- ➔ **RS422**      **DEFAULT**      Enables serial port RS422 support
- ➔ **RS485**                      Enables serial port RS485 support.

### 6.3.7 F81866 H/W Monitor

The H/W Monitor menu (**BIOS Menu 10**) shows the operating temperature, fan speeds and system voltages.

```

Aptio Setup Utility - Copyright (C) 2009 American Megatrends, Inc.
-----
Advanced
-----
PC Health Status

CPU temperature           :+44 C
System temperature       :+38 C
V_core                    :+1.048 V
VCC5                      :+4.940 V
Vcc12                     :+11.660 V
VDDR                      :+1.512 V
VSB5V                     :+5.016 V
+V3.3S                    :+3.376 V
VSB3V                     :+3.360 V
VBAT                      :+3.312 V

-----
<->: Select Screen
↑ ↓: Select Item
Enter>Select
F1   General Help
F2   Previous Values
F3   Optimized
Defaults
F4   Save
ESC  Exit

Version 2.14.1219. Copyright (C) 2011 American Megatrends, Inc.
    
```

#### BIOS Menu 10: Hardware Health Configuration

➔ PC Health Status

The following system parameters and values are shown. The system parameters that are monitored are:

- System Temperatures:
  - CPU temperature
  - System temperature
- Voltages:

## uIBX-210-CV-N2600 Embedded System

- V\_core
- VCC5
- Vcc12
- VDDR
- VSB5V
- +V3.3S
- VSB3V
- VBAT

### 6.3.8 Serial Port Console Redirection

The **Serial Port Console Redirection** menu (**BIOS Menu 11**) allows the console redirection options to be configured. Console redirection allows users to maintain a system remotely by re-directing keyboard input and text output through the serial port.

```

Aptio Setup Utility - Copyright (C) 2009 American Megatrends, Inc.
  Advanced
COM1
  Console Redirection          [Disabled]
> Console Redirection Settings
                                Console Redirection
                                Enable or Disable.
                                -----
                                ←→: Select Screen
                                ↑ ↓: Select Item
                                EnterSelect
                                F1  General Help
                                F2  Previous Values
                                F3  Optimized
                                Defaults
                                F4  Save
                                ESC  Exit
COM2
  Console Redirection          [Disabled]
> Console Redirection Settings
Version 2.14.1219. Copyright (C) 2011 American Megatrends, Inc.

```

#### BIOS Menu 11: Serial Port Console Redirection

➔ Console Redirection

Use **Console Redirection** option to enable or disable the console redirection function.

- ➔ **Disabled**    **DEFAULT**    Disables the console redirection function.
- ➔ **Enabled**       Enabled the console redirection function.

### 6.3.8.1 Console Redirection Settings

The **Console Redirection Settings** menu (**BIOS Menu 12**) allows the console redirection options to be configured. The option is active when Console Redirection option is enabled.



#### BIOS Menu 12: Console Redirection Settings

##### → Terminal Type [ANSI]

Use the **Terminal Type** option to specify the remote terminal type..

- **VT100**                                      The target terminal type is VT100
- **VT100+**                                    The target terminal type is VT100+
- **VT-UTF8**                                    The target terminal type is VT-UTF8
- **ANSI**                                        **DEFAULT**                                    The target terminal type is ANSI

##### → Bits per second [115200]

Use the **Bits per second** option to specify the transmission speed of the serial port.

## uIBX-210-CV-N2600 Embedded System

- **9600**                      The transmission speed is 9600
- **19200**                     The transmission speed is 19200
- **38400**                     The transmission speed is 38400
- **57600**                     The transmission speed is 57600
- **115200**            **DEFAULT**      The transmission speed is 115200

### → Data Bits [8]

Use the **Data Bits** option to specify the number of data bits.

- **7**                              Sets the data bits at 7.
- **8**                              **DEFAULT**      Sets the data bits at 8.

### → Parity [None]

Use the **Parity** option to specify the parity bit that can be sent with the data bits for detecting the transmission errors.

- **None**                    **DEFAULT**      No parity bit is sent with the data bits.
- **Even**                     The parity bit is 0 if the number of ones in the data bits is even.
- **Odd**                      The parity bit is 0 if the number of ones in the data bits is odd.
- **Mark**                    The parity bit is always 1. This option does not provide error detection.
- **Space**                    The parity bit is always 0. This option does not provide error detection.

### → Stop Bits [1]

Use the **Stop Bits** option to specify the number of stop bits used to indicate the end of a serial data packet. Communication with slow devices may require more than 1 stop bit.



- ➔ 1            **DEFAULT**      Sets the number of stop bits at 1.
- ➔ 2                              Sets the number of stop bits at 2.

## 6.4 iEi Feature

Use the **iEi Feature** menu (**BIOS Menu 13**) to configure the auto recovery function.

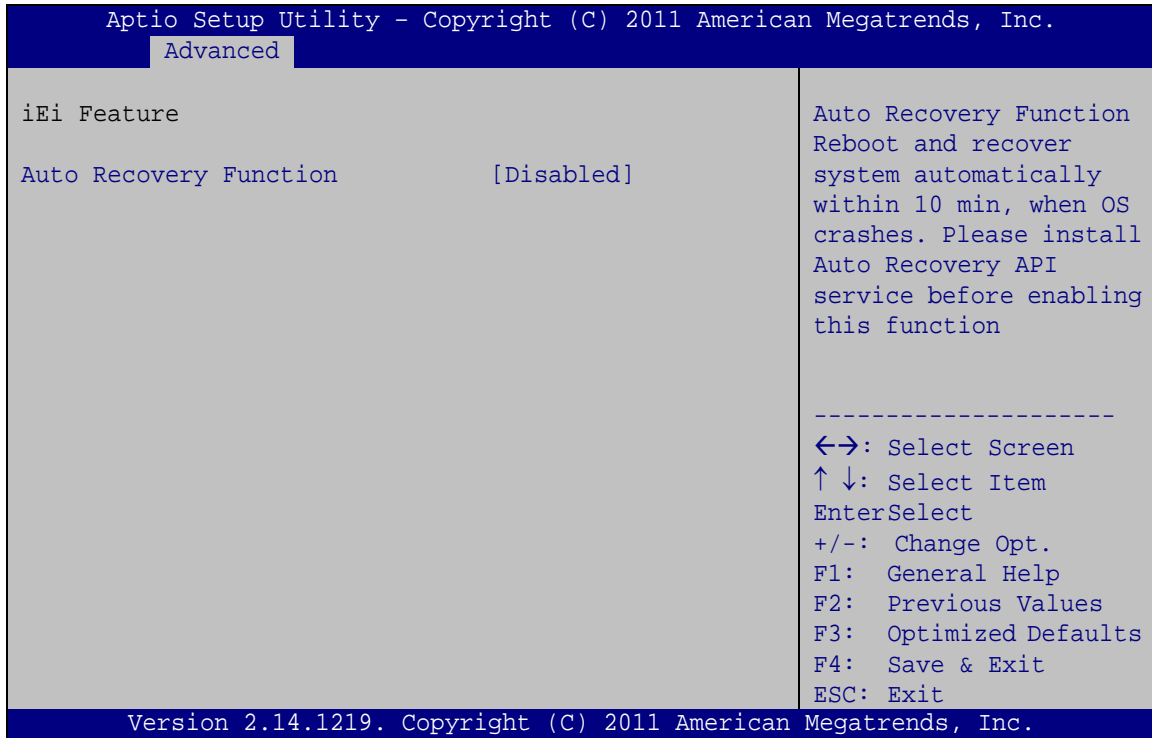

### BIOS Menu 13: iEi Feature

- ➔ Auto Recovery Function [Disabled]

Use the **Auto Recovery Function** option to enable or disable auto recovery on the system.

- ➔ **Disabled**      **DEFAULT**      Auto Recovery Function support disabled
- ➔ **Enabled**                      Auto Recovery Function support enabled

## 6.5 Chipset

Use the **Chipset** menu (**BIOS Menu 14**) to access the Host Bridge and South Bridge configuration menus



### WARNING!

Setting the wrong values for the Chipset BIOS selections in the Chipset BIOS menu may cause the system to malfunction.

```
Aptio Setup Utility - Copyright (C) 2011 American Megatrends, Inc.
Main   Advanced  Chipset  Boot   Security  Save & Exit
-----
> Host Bridge
> South Bridge

Host Bridge Parameters
-----
<=>: Select Screen
↑ ↓: Select Item
Enter>Select
+/-: Change Opt.
F1   General Help
F2   Previous Values
F3   Optimized Defaults
F4   Save & Exit
ESC  Exit

Version 2.14.1219. Copyright (C) 2011 American Megatrends, Inc.
```

**BIOS Menu 14: Chipset**

## 6.5.1 Host Bridge Configuration

Use the **Host Bridge Configuration** menu (**BIOS Menu 15**) to configure the Intel IGD settings.

```

Aptio Setup Utility - Copyright (C) 2011 American Megatrends, Inc.
  Chipset
> Intel IGD Configuration
*****Memory Information*****
Memory Frequency           800 MHz(DDR3)
Total Memory               2048 MB
DIMM1                     2048 MB

-----
<=>: Select Screen
↑ ↓: Select Item
EnterSelect
+/-: Change Opt.
F1:  General Help
F2:  Previous Values
F3:  Optimized Defaults
F4:  Save & Exit
ESC: Exit

Version 2.14.1219. Copyright (C) 2011 American Megatrends, Inc.
    
```

### BIOS Menu 15: Northbridge Chipset Configuration

#### ➔ Memory Information

The **Memory Information** lists a brief summary of the on-board memory. The fields in **Memory Information** cannot be changed.

#### 6.5.1.1 Intel IGD Configuration

Use the **Intel IGD Configuration** menu (**BIOS Menu 16**) to configure the video device connected to the system.

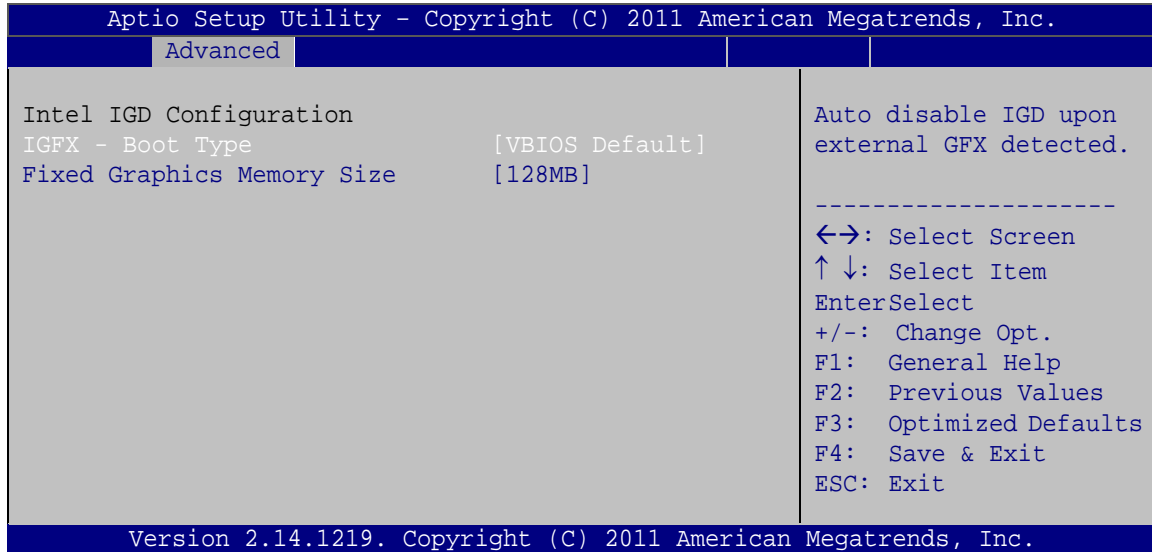

### BIOS Menu 16: Integrated Graphics

#### → IGFX - Boot Type [VBIOS Default]

Use the **IGFX - Boot Type** option to select the display device used by the system when it boots. For dual display support, select “VBIOS Deafult.” Configuration options are listed below.

- VBIOS Default **DEFAULT**
- CRT
- HDMI
- CRT + HDMI

#### → Fixed Graphics Memory Size [128 MB]

Use the **Fixed Graphics Memory Size** option to specify the amount of memory that can be allocated as graphics memory. Configuration options are listed below.

- 128 MB **DEFAULT**
- 256 MB

### 6.5.2 Southbridge Configuration

Use the **Southbridge Configuration** menu (**BIOS Menu 17**) to configure the Southbridge chipset.

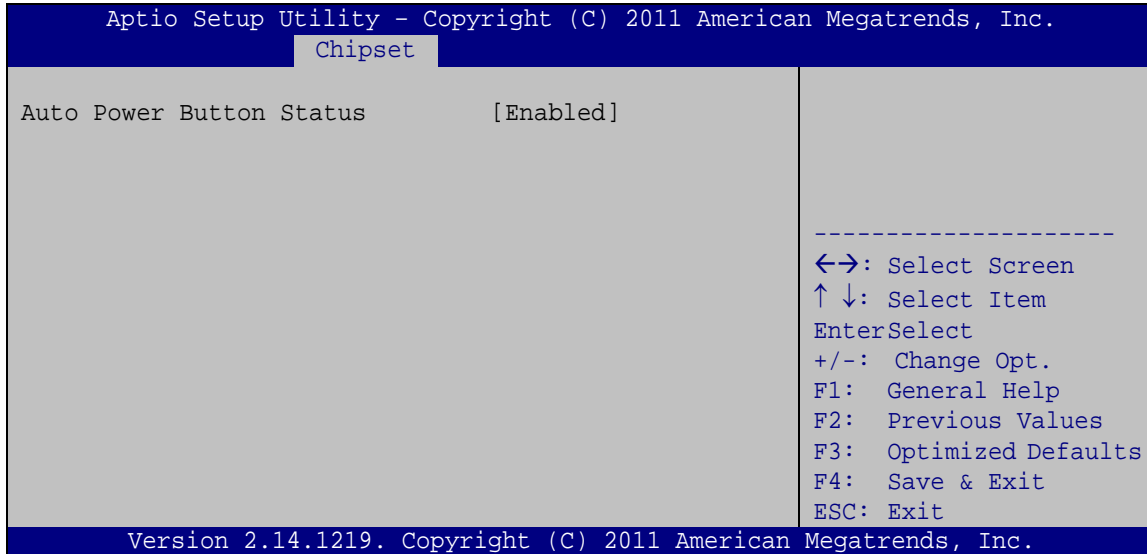

### BIOS Menu 17: Southbridge Chipset Configuration

## 6.6 Boot

Use the **Boot** menu (**BIOS Menu 18**) to configure system boot options.

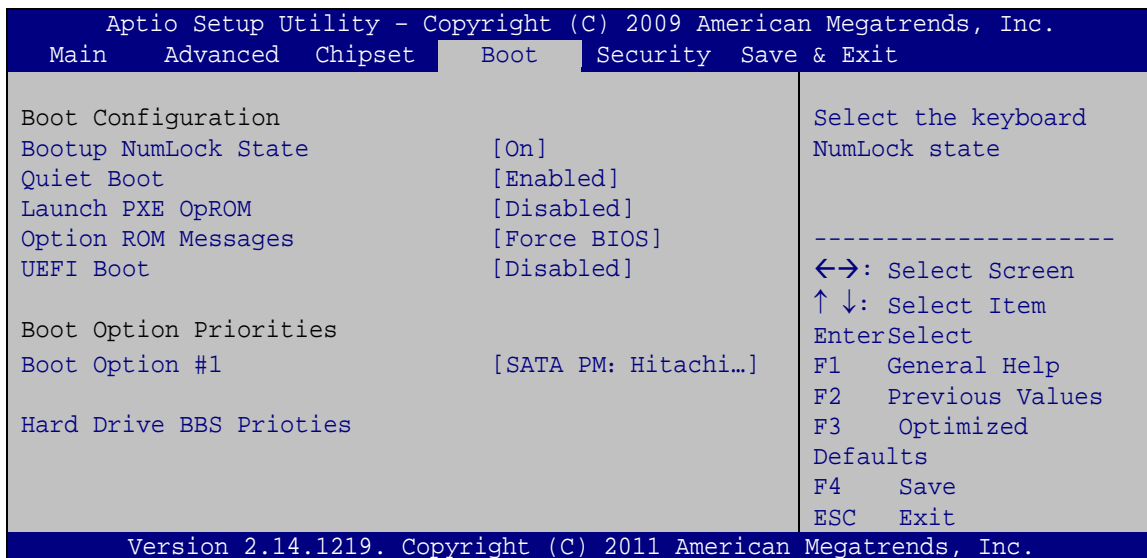

### BIOS Menu 18: Boot

➔ Bootup NumLock State [On]

Use the **Bootup NumLock State** BIOS option to specify if the number lock setting must be modified during boot up.

- ➔ **Off** Does not enable the keyboard Number Lock automatically. To use the 10-keys on the keyboard, press the Number Lock key located on the upper left-hand corner of the 10-key pad. The Number Lock LED on the keyboard lights up when the Number Lock is engaged.
- ➔ **On DEFAULT** Allows the Number Lock on the keyboard to be enabled automatically when the computer system boots up. This allows the immediate use of the 10-key numeric keypad located on the right side of the keyboard. To confirm this, the Number Lock LED light on the keyboard is lit.

➔ **Quiet Boot [Enabled]**

Use the **Quiet Boot** BIOS option to select the screen display when the system boots.

- ➔ **Disabled** Normal POST messages displayed
- ➔ **Enabled DEFAULT** OEM Logo displayed instead of POST messages

➔ **Launch PXE OpROM [Disabled]**

Use the **Launch PXE OpROM** BIOS option to enable or disable boot option for legacy network devices.

- ➔ **Disabled DEFAULT** Cannot be booted from the legacy network devices.
- ➔ **Enabled** Can be booted from the legacy network devices.

➔ **Option ROM Messages [Force BIOS]**

Use the **Option ROM Messages** option to allow add-on ROM (read-only memory) messages to be displayed.

- ➔ **Force BIOS DEFAULT** The system forces third party BIOS to display during system boot.
- ➔ **Keep Current** The system displays normal information during system boot.

→ **UEFI Boot [Disabled]**

Use the **UEFI Boot** option to enable or disable to boot from the UEFI devices.

- **Enabled**                      Boot from UEFI devices is enabled.
- **Disabled      DEFAULT**      Boot from UEFI devices is disabled.

→ **Boot Option Priority**

Use the **Boot Option Priority** function to set the system boot sequence from the available devices. The drive sequence also depends on the boot sequence in the individual device section.

→ **Hard Drive BBS Priorities**

Use **Hard Drive BBS Priorities** option to set the system boot order.

## 6.7 Security

Use the **Security** menu (**BIOS Menu 19**) to set system and user passwords.

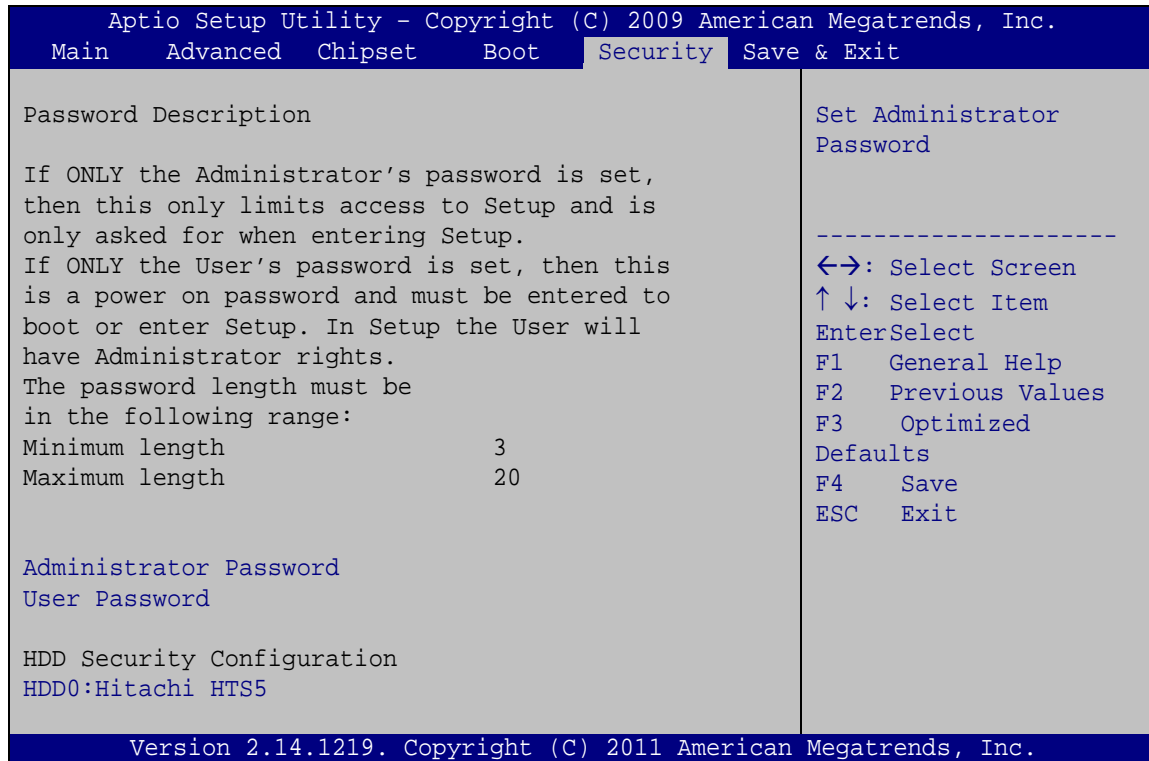

### BIOS Menu 19: Security

#### → Administrator Password

Use the **Administrator Password** to set or change a administrator password.

#### → User Password

Use the **User Password** to set or change a user password.



### 6.7.1 HDD Security Configuration

Use the **HDD Security Configuration** submenu (**BIOS Menu 20**) to set HDD password.

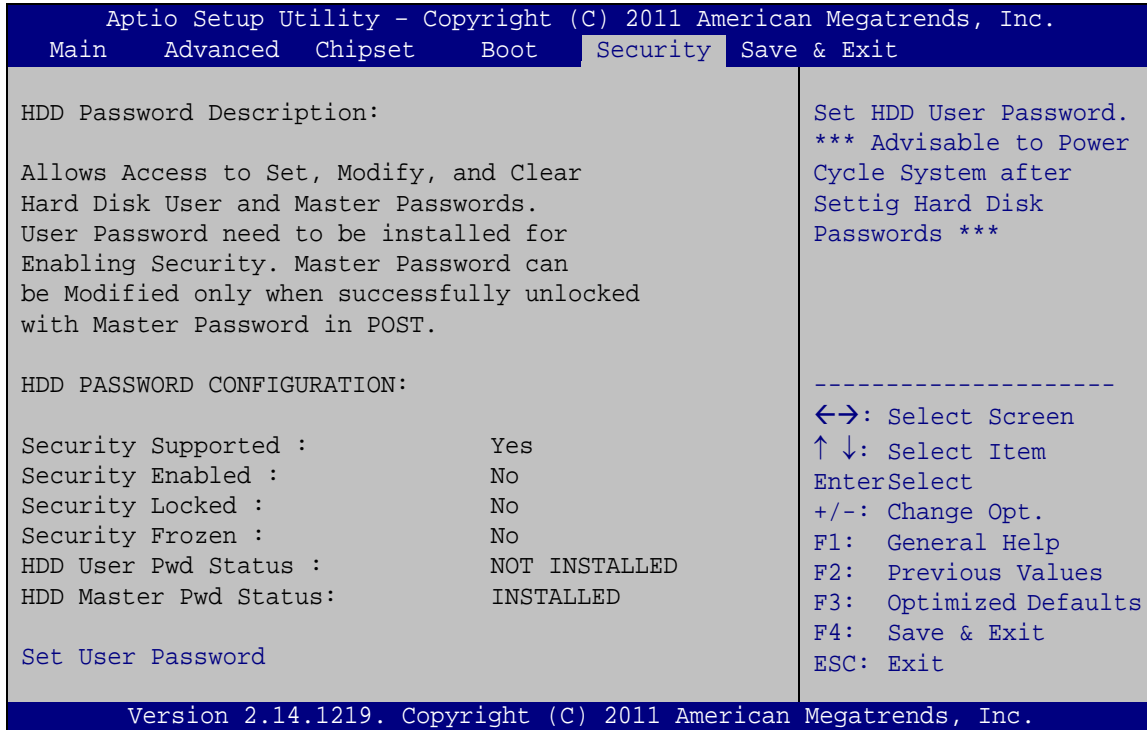

#### BIOS Menu 20: Security

→ Set User Password

Use the **Set User Password** field to set or change an HDD user password.



#### NOTE:

It is recommended that the system be reset after setting a new HDD password.

## 6.8 Save & Exit

Use the **Save & Exit** menu (**BIOS Menu 21**) to load default BIOS values, optimal failsafe values and to save configuration changes.

```

Aptio Setup Utility - Copyright (C) 2009 American Megatrends, Inc.
Main   Advanced  Chipset   Boot     Security  Save & Exit
-----
Save Changes and Reset
Discard Changes and Reset

Restore Defaults
Save as User Defaults
Restore User Defaults

Reset the system after
saving the changes.

-----
<->: Select Screen
↑ ↓: Select Item
Enter>Select
F1   General Help
F2   Previous Values
F3   Optimized
Defaults
F4   Save
ESC  Exit

Version 2.14.1219. Copyright (C) 2011 American Megatrends, Inc.
  
```

### BIOS Menu 21:Exit

#### → Save Changes and Reset

Use the **Save Changes and Reset** option to save the changes made to the BIOS options and to exit the BIOS configuration setup program.

#### → Discard Changes and Reset

Use the **Discard Changes and Reset** option to exit the system without saving the changes made to the BIOS configuration setup program.

#### → Restore Defaults

Use the **Restore Defaults** option to load the optimal default values for each of the parameters on the Setup menus. **F3 key can be used for this operation.**

➔ Save as User Defaults

Use the **Save as User Defaults** option to save the changes done so far as user defaults.

➔ Restore User Defaults

Use the **Restore User Defaults** option to restore the user defaults to all the setup options.

Chapter

5

# Software Drivers

---

## 7.1 Available Software Drivers

---



### NOTE:

The content of the CD may vary throughout the life cycle of the product and is subject to change without prior notice. Visit the IEI website or contact technical support for the latest updates.

---

The following drivers can be installed on the system:

- Chipset
- Graphic
- Audio
- LAN

Installation instructions are given below.

## 7.2 Starting the Driver Program

To access the driver installation programs, please do the following.

- Step 1:** Insert the CD-ROM that came with the system into a CD-ROM drive attached to the system.
- Step 2:** Click **uIBX-210-CV-N2600 Driver**.
- Step 3:** A list of available drivers appears.

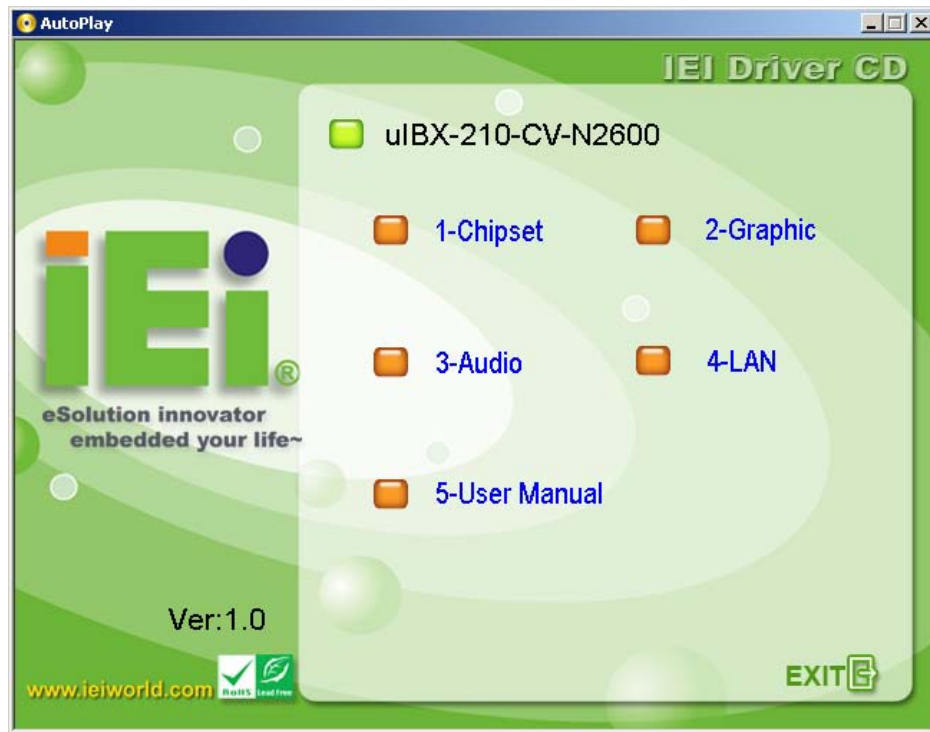
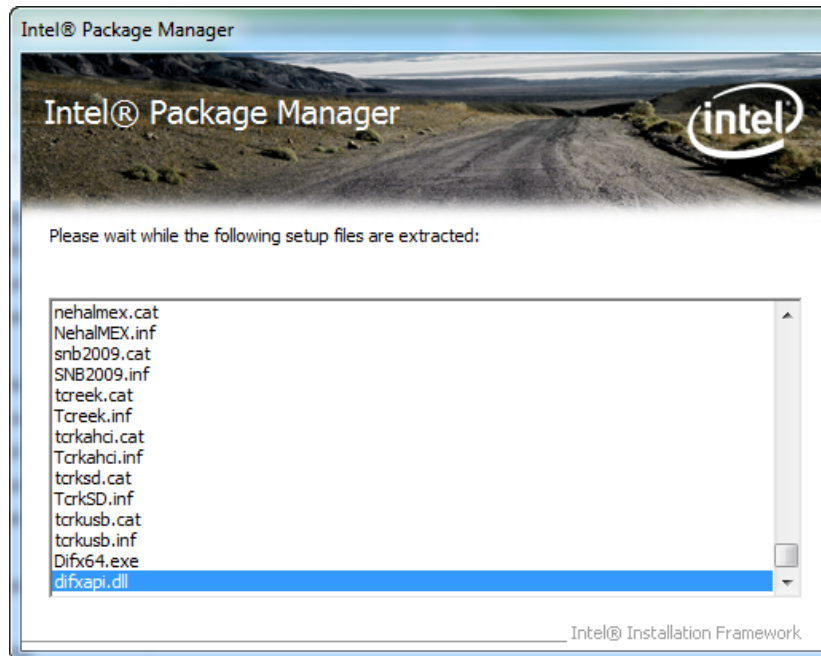

Figure 7-1: Drivers

### 7.3 Chipset Driver Installation

To install the chipset driver, please do the following.

- Step 1: Access the driver list. (See **Section 7.2**)
- Step 2: Click “1-Chipset”
- Step 3: Locate the setup file and double click on it.
- Step 4: The setup files are extracted as shown in **Figure 7-2**.



**Figure 7-2: Chipset Driver Screen**

**Step 5:** When the setup files are completely extracted, the **Welcome Screen** in **Figure 7-3** appears.



**Figure 7-3: Chipset Driver Welcome Screen**

**Step 6:** Click **Next** to continue.

## uIBX-210-CV-N2600 Embedded System

**Step 7:** The license agreement in **Figure 7-4** appears.

**Step 8:** Read the **License Agreement**.

**Step 9:** Click **Yes** to continue.

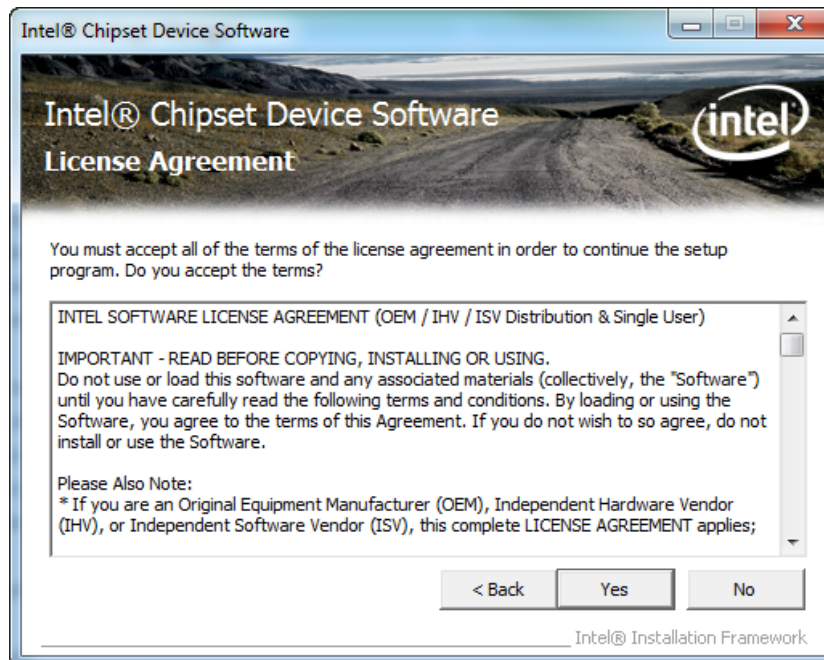

**Figure 7-4: Chipset Driver License Agreement**

**Step 10:** The Read Me file in **Figure 7-5** appears.

**Step 11:** Click **Next** to continue.



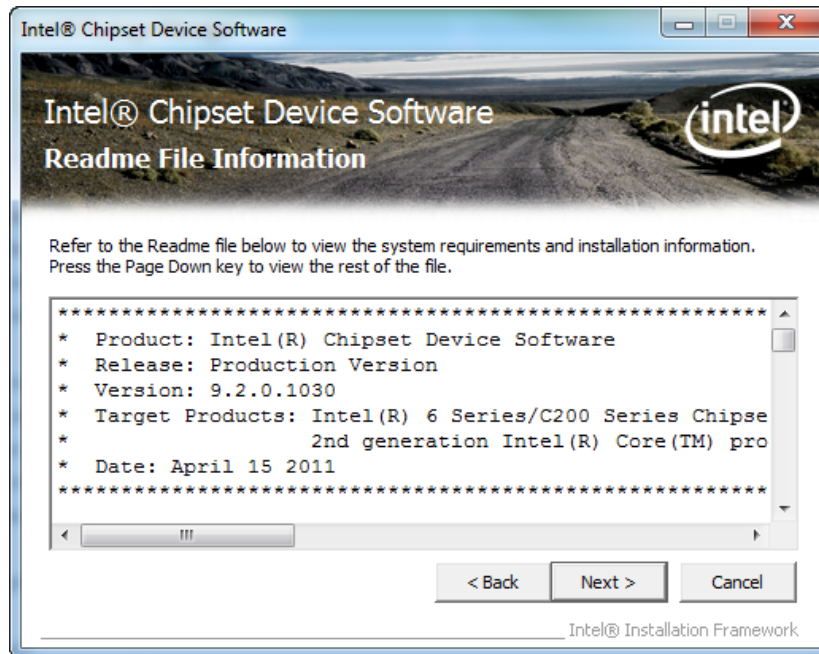

Figure 7-5: Chipset Driver Read Me File

Step 12: Once the **Setup Operations** are complete, the **Finish** screen appears.

Step 13: Click **Finish** to complete installation.



Figure 7-6: Chipset Driver Installation Finish Screen

## 7.4 Graphic Driver Installation

To install the VGA driver, please do the following.

**Step 1:** Access the driver list. (See **Section 7.2**)

**Step 2:** Click “**2-Graphic**”

**Step 3:** Locate the setup file and double click on it.

**Step 4:** The **Welcome Screen** in **Figure 7-7** appears.

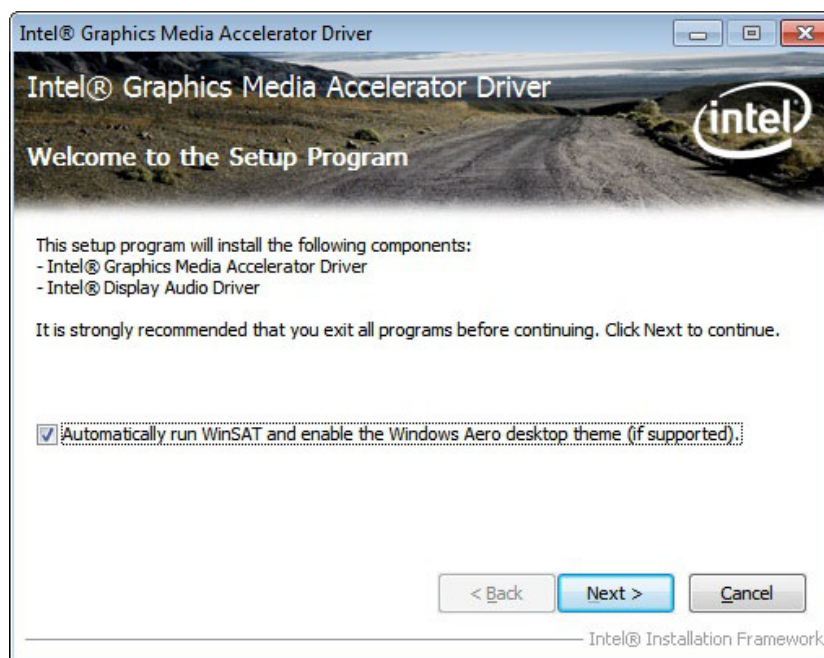

**Figure 7-7: VGA Driver Welcome Screen**

**Step 5:** Click **Next** to continue.

**Step 6:** The license agreement in **Figure 7-8** appears.

**Step 7:** Read the **License Agreement**.

**Step 8:** Click **Yes** to continue.



Figure 7-8: VGA Driver License Agreement

Step 9: The Read Me file in **Figure 7-9** appears.

Step 10: Click **Next** to continue.

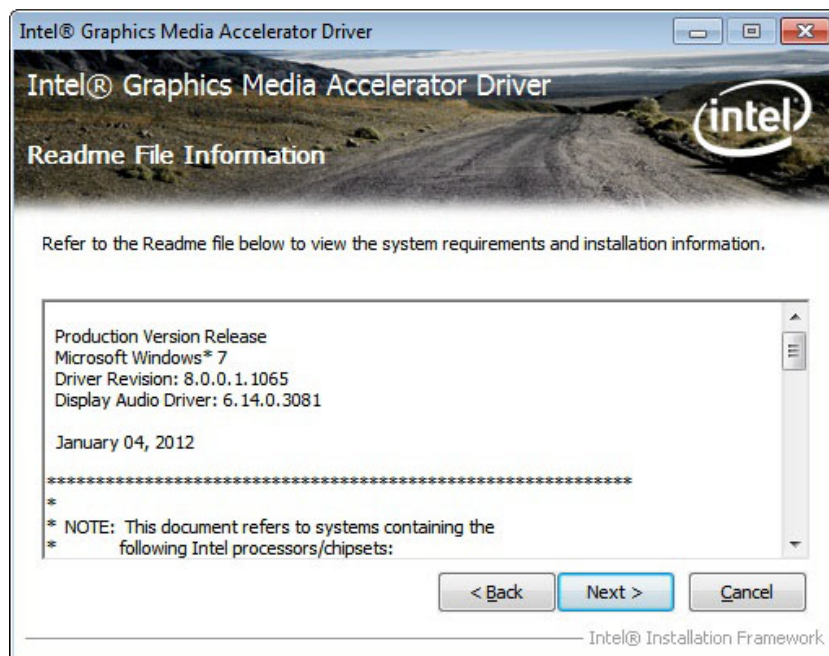
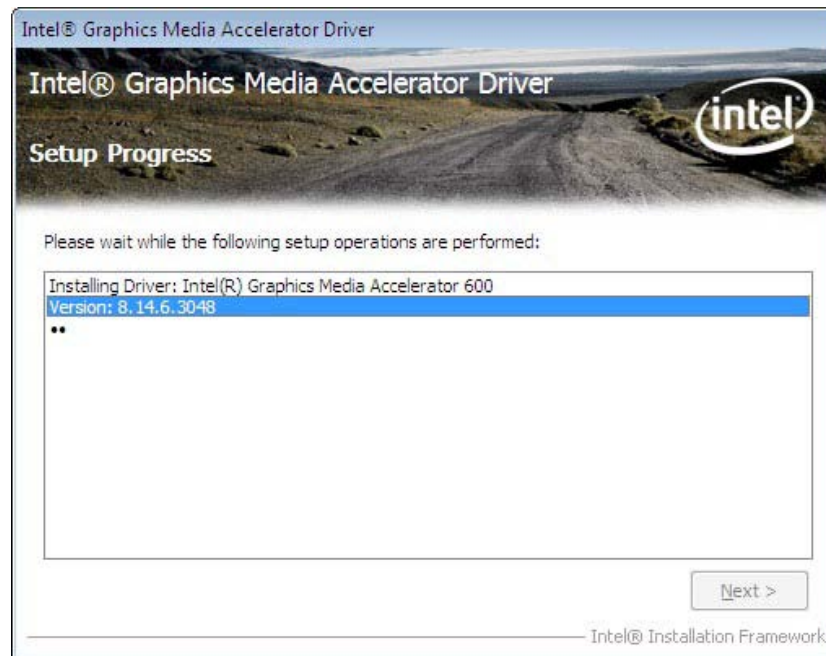

Figure 7-9: VGA Driver Read Me File

**Step 11:** Setup Operations are performed as shown in **Figure 7-10**.



**Figure 7-10: VGA Driver Setup Operations**

**Step 12:** Once the **Setup Operations** are complete, click the **Next** icon to continue.

**Step 13:** The **Finish** screen appears.

**Step 14:** Select “**Yes, I want to restart the computer now**” and click the **Finish** icon.

See **Figure 7-11**.

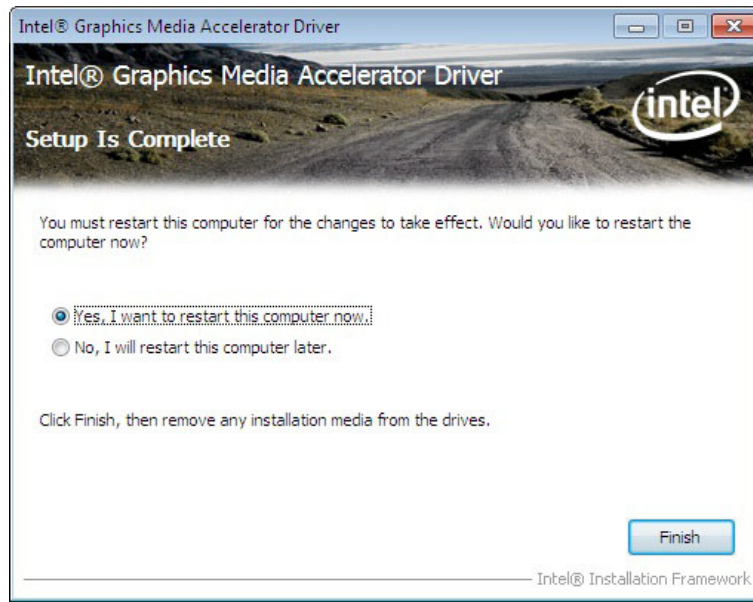

Figure 7-11: VGA Driver Installation Finish Screen

## 7.5 LAN Driver Installation

Step 1: Right-click the Computer button from the start menu and select **Properties**.

(Figure 7-12).

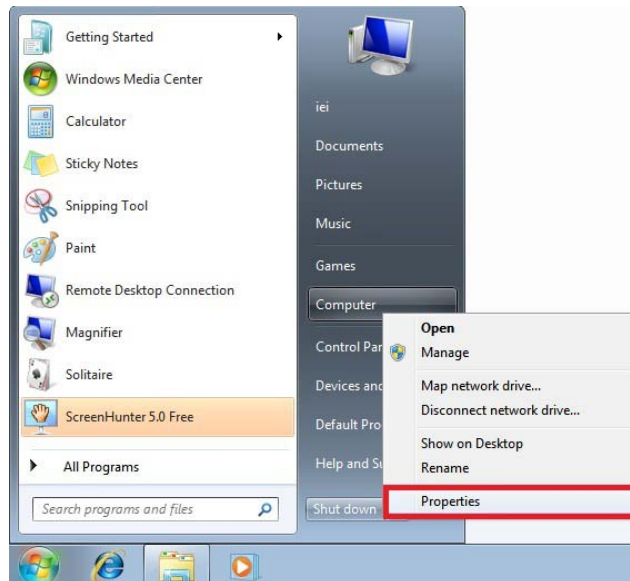
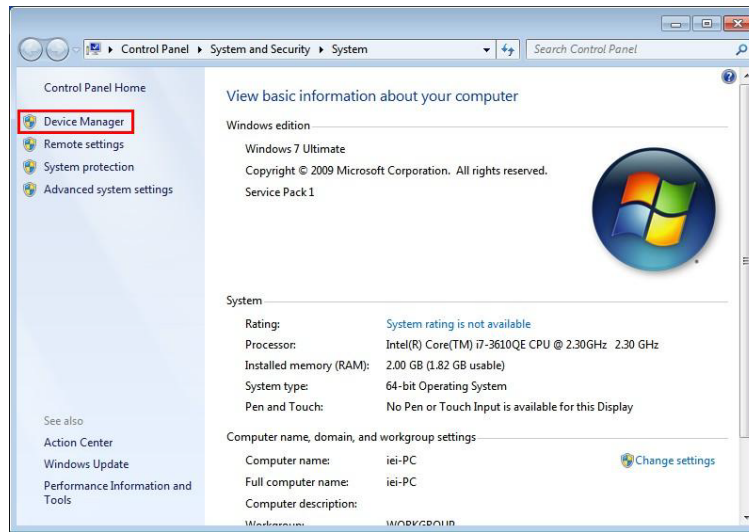

Figure 7-12: Windows Control Panel

Step 2: The system control panel window in Figure 7-13 appears.

## uIBX-210-CV-N2600 Embedded System

**Step 3:** Click the Device Manager link (**Figure 7-13**).



**Figure 7-13: System Control Panel**

**Step 4:** A list of system hardware devices appears (**Figure 7-14**).

**Step 5:** Right-click the Ethernet Controller that has question marks next to it (this means Windows does not recognize the device).

**Step 6:** Select **Update Driver Software**.

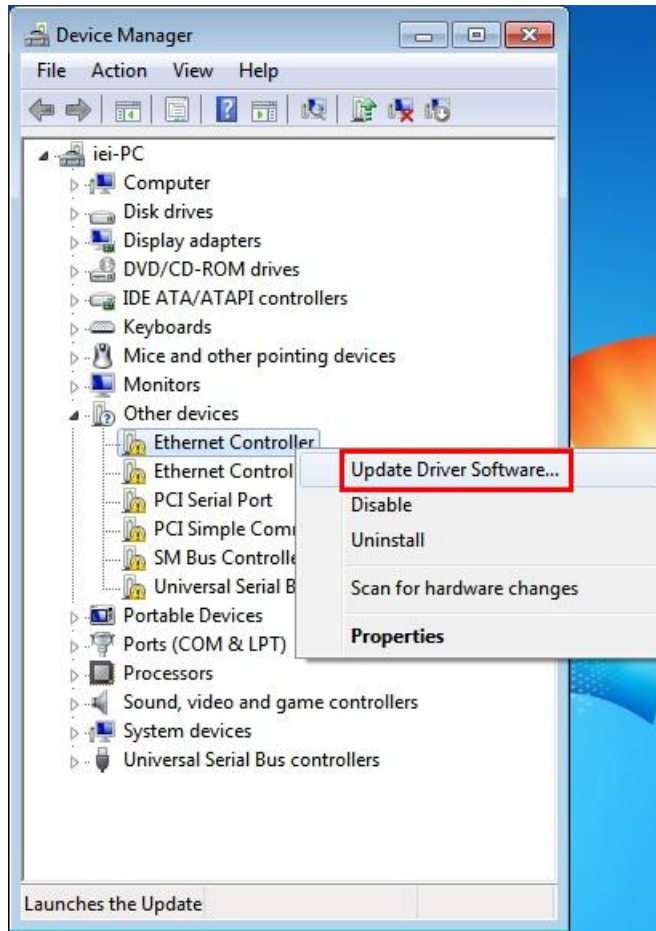
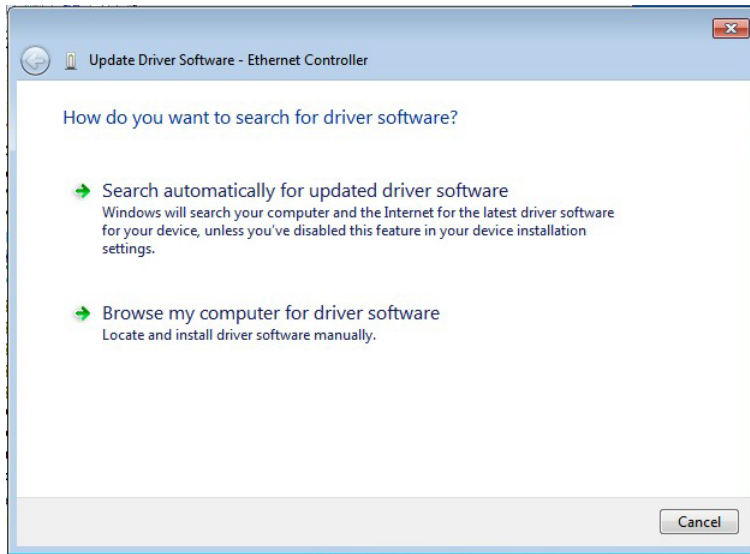

Figure 7-14: Device Manager List

Step 7: The Update Driver Software Window appears (Figure 7-15).



**Figure 7-15: Update Driver Software Window**

**Step 8:** Select “Browse my computer for driver software” and click **BROWSE** to select the driver location (**Figure 7-16**).

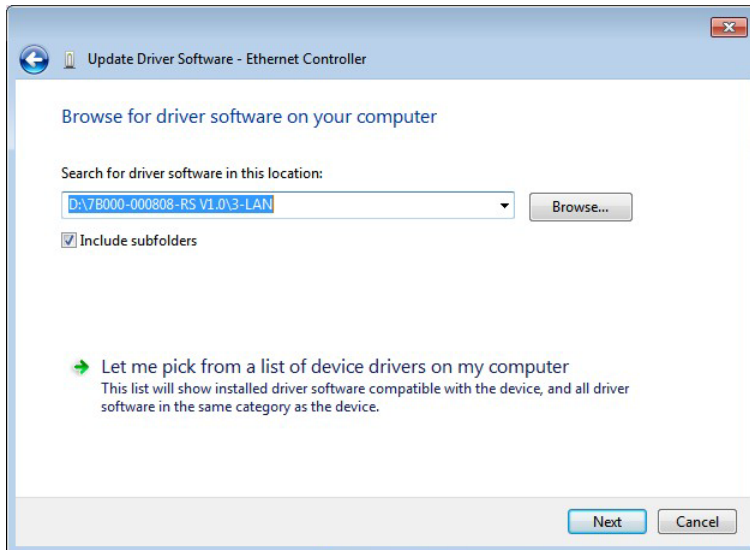
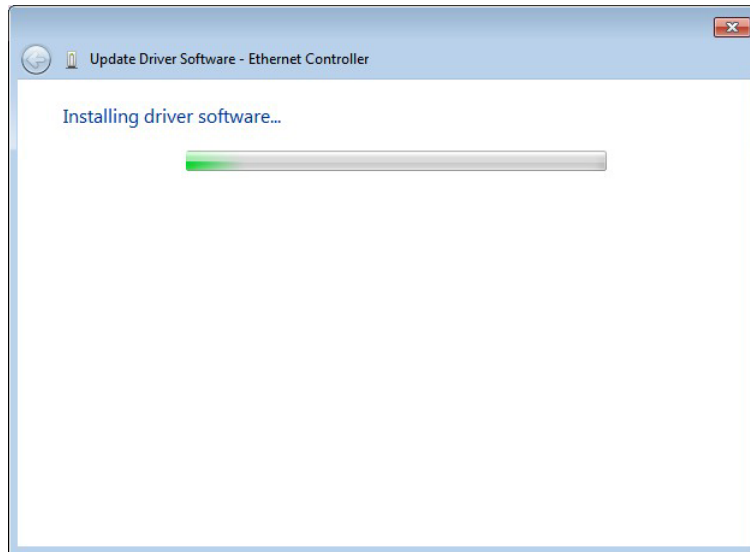

**Figure 7-16: Locate Driver Files**

**Step 9:** Click **NEXT** to continue.

**Step 10:** Driver Installation is performed as shown in **Figure 7-17**.





**Figure 7-17: LAN Driver Installation**

**Step 11:** The **Finish** screen in **Figure 7-18** appears. Click **Close** to exit.

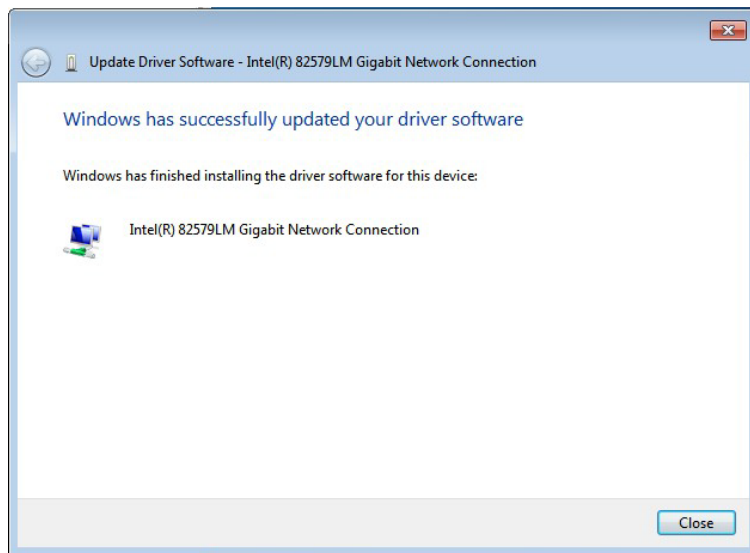

**Figure 7-18: LAN Driver Installation Complete**

## 7.6 Audio Driver Installation

To install the audio driver, please do the following.

**Step 1:** Access the driver list. (See **Section 7.2**)

## uIBX-210-CV-N2600 Embedded System

**Step 2:** Click **“Audio”** and select the folder which corresponds to your operating system.

**Step 3:** Double click the setup file.

**Step 4:** The **Audio Driver Welcome Screen** in **Figure 7-19** appears.

**Step 5:** Click **Next** to continue.

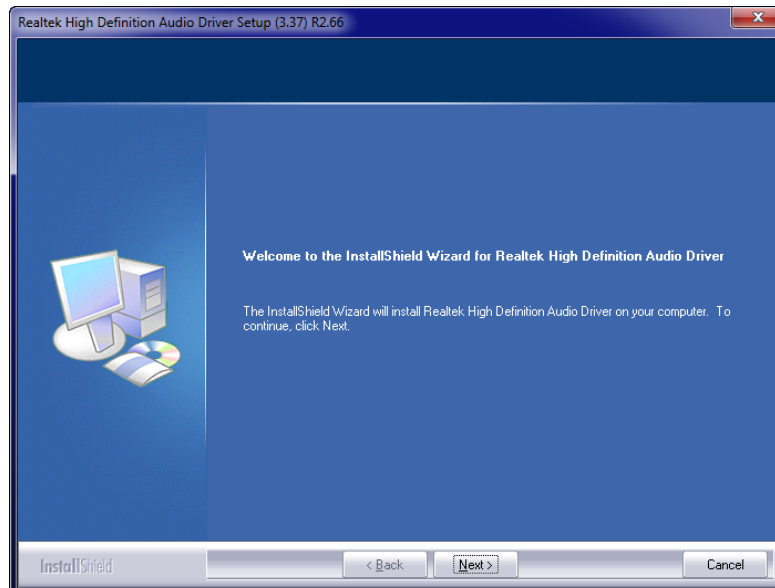

**Figure 7-19: Audio Driver Welcome Screen**

**Step 6:** The audio driver installation begins. See **Figure 7-20**.

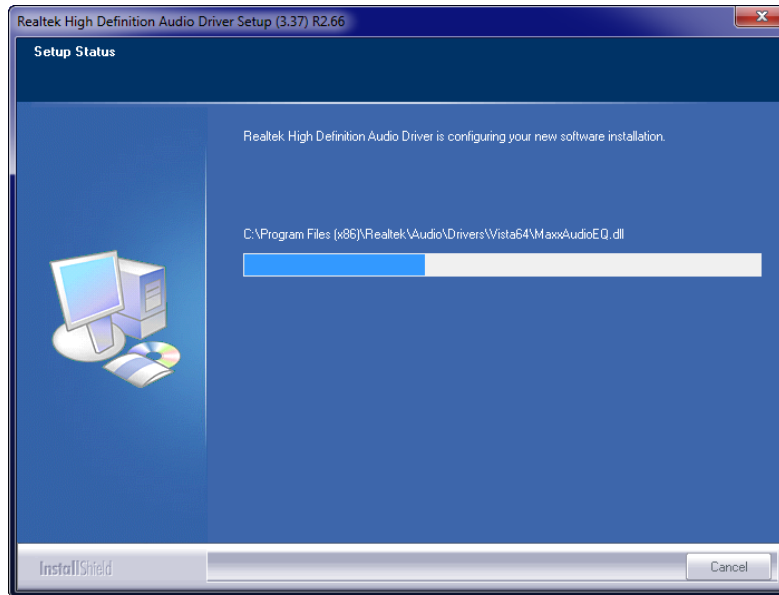

Figure 7-20: Audio Driver Installation

Step 7: When the installation is complete, the screen in **Figure 7-21** appears.

Step 8: Select “**Yes, I want to restart my computer now**” and click **Finish**.

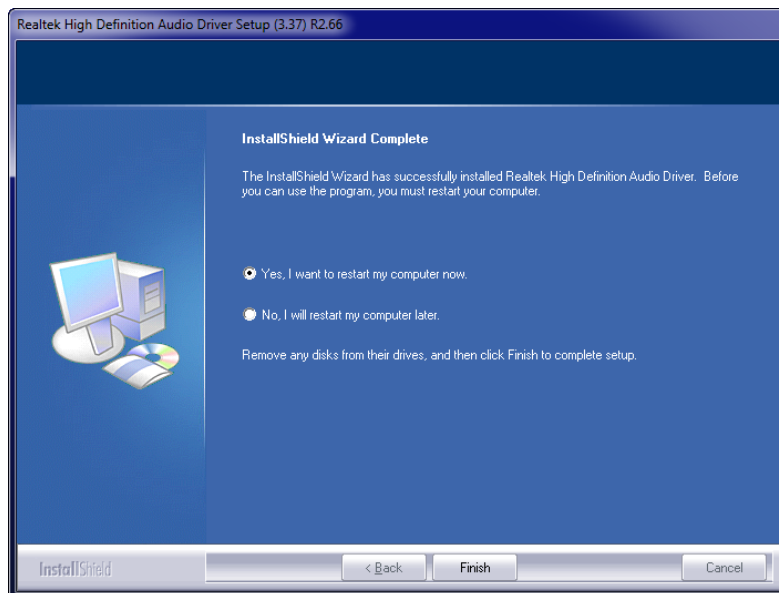

Figure 7-21: Audio Driver Installation Complete

Appendix

A

# Safety Precautions

---

**WARNING:**

The precautions outlined in this chapter should be strictly followed. Failure to follow these precautions may result in permanent damage to the uIBX-210-CV-N2600.

## A.1 Safety Precautions

Please follow the safety precautions outlined in the sections that follow:

### A.1.1 General Safety Precautions

Please ensure the following safety precautions are adhered to at all times.

- **Follow the electrostatic precautions** outlined below whenever the uIBX-210-CV-N2600 is opened.
- **Make sure the power is turned off and the power cord is disconnected** whenever the uIBX-210-CV-N2600 is being installed, moved or modified.
- **Do not apply voltage levels that exceed the specified voltage range.** Doing so may cause fire and/or an electrical shock.
- **Electric shocks can occur** if the uIBX-210-CV-N2600 chassis is opened when the uIBX-210-CV-N2600 is running.
- **Do not drop or insert any objects** into the ventilation openings of the uIBX-210-CV-N2600.
- **If considerable amounts of dust, water, or fluids enter the uIBX-210-CV-N2600**, turn off the power supply immediately, unplug the power cord, and contact the uIBX-210-CV-N2600 vendor.
- **DO NOT:**
  - Drop the uIBX-210-CV-N2600 against a hard surface.
  - Strike or exert excessive force onto the LCD panel.
  - Touch any of the LCD panels with a sharp object
  - In a site where the ambient temperature exceeds the rated temperature

### A.1.2 Anti-static Precautions

---



#### WARNING:

Failure to take ESD precautions during the installation of the uIBX-210-CV-N2600 may result in permanent damage to the uIBX-210-CV-N2600 and severe injury to the user.

---

Electrostatic discharge (ESD) can cause serious damage to electronic components, including the uIBX-210-CV-N2600. Dry climates are especially susceptible to ESD. It is therefore critical that whenever the uIBX-210-CV-N2600 is opened and any of the electrical components are handled, the following anti-static precautions are strictly adhered to.

- **Wear an anti-static wristband:** Wearing a simple anti-static wristband can help to prevent ESD from damaging any electrical component.
- **Self-grounding:** Before handling any electrical component, touch any grounded conducting material. During the time the electrical component is handled, frequently touch any conducting materials that are connected to the ground.
- **Use an anti-static pad:** When configuring or working with an electrical component, place it on an anti-static pad. This reduces the possibility of ESD damage.
- **Only handle the edges of the electrical component:** When handling the electrical component, hold the electrical component by its edges.

### A.1.3 Product Disposal

---



#### **CAUTION:**

Risk of explosion if battery is replaced by and incorrect type. Only certified engineers should replace the on-board battery.

Dispose of used batteries according to instructions and local regulations.

---

- Outside the European Union - If you wish to dispose of used electrical and electronic products outside the European Union, please contact your local authority so as to comply with the correct disposal method.
- Within the European Union:

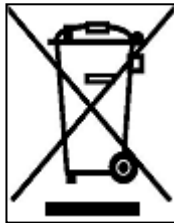

EU-wide legislation, as implemented in each Member State, requires that waste electrical and electronic products carrying the mark (left) must be disposed of separately from normal household waste. This includes monitors and electrical accessories, such as signal cables or power cords.

When you need to dispose of your display products, please follow the guidance of your local authority, or ask the shop where you purchased the product. The mark on electrical and electronic products only applies to the current European Union Member States.

Please follow the national guidelines for electrical and electronic product disposal.

## A.2 Maintenance and Cleaning Precautions

When maintaining or cleaning the uIBX-210-CV-N2600, please follow the guidelines below.

### A.2.1 Maintenance and Cleaning

Prior to cleaning any part or component of the uIBX-210-CV-N2600, please read the details below.

## uIBX-210-CV-N2600 Embedded System

- The interior of the uIBX-210-CV-N2600X does not require cleaning. Keep fluids away from the uIBX-210-CV-N2600 interior.
- Be cautious of all small removable components when vacuuming the uIBX-210-CV-N2600.
- Turn the uIBX-210-CV-N2600 off before cleaning the uIBX-210-CV-N2600.
- Never drop any objects or liquids through the openings of the uIBX-210-CV-N2600.
- Be cautious of any possible allergic reactions to solvents or chemicals used when cleaning the uIBX-210-CV-N2600.
- Avoid eating, drinking and smoking within vicinity of the uIBX-210-CV-N2600.

### A.2.2 Cleaning Tools

Some components in the uIBX-210-CV-N2600 may only be cleaned using a product specifically designed for the purpose. In such case, the product will be explicitly mentioned in the cleaning tips. Below is a list of items to use when cleaning the uIBX-210-CV-N2600.

- **Cloth** – Although paper towels or tissues can be used, a soft, clean piece of cloth is recommended when cleaning the uIBX-210-CV-N2600.
- **Water or rubbing alcohol** – A cloth moistened with water or rubbing alcohol can be used to clean the LuIBX-210-CV-N2600.
- **Using solvents** – The use of solvents is not recommended when cleaning the LuIBX-210-CV-N2600 as they may damage the plastic parts.
- **Vacuum cleaner** – Using a vacuum specifically designed for computers is one of the best methods of cleaning the uIBX-210-CV-N2600. Dust and dirt can restrict the airflow in the uIBX-210-CV-N2600 and cause its circuitry to corrode.
- **Cotton swabs** - Cotton swaps moistened with rubbing alcohol or water are excellent tools for wiping hard to reach areas.
- **Foam swabs** - Whenever possible, it is best to use lint free swabs such as foam swabs for cleaning.



Appendix

**B**

# BIOS Menu Options

---

|  |    |
|--|----|
| ➔ BIOS Information .....                       | 53 |
| ➔ System Date [xx/xx/xx] .....                 | 53 |
| ➔ System Time [xx:xx:xx] .....                 | 54 |
| ➔ ACPI Sleep State [S1 (CPU Stop Clock)] ..... | 55 |
| ➔ Wake system with Fixed Time [Disabled].....  | 56 |
| ➔ Hyper-Threading [Disabled].....              | 58 |
| ➔ SATA Mode [AHCI].....                        | 58 |
| ➔ USB Devices .....                            | 59 |
| ➔ Legacy USB Support [Enabled].....            | 59 |
| ➔ Serial Port [Enabled].....                   | 61 |
| ➔ Change Settings [Auto] .....                 | 61 |
| ➔ Serial Port [Enabled].....                   | 62 |
| ➔ Change Settings [Auto] .....                 | 62 |
| ➔ Serial Port [Enabled].....                   | 63 |
| ➔ Change Settings [Auto] .....                 | 63 |
| ➔ Device Mode [RS422].....                     | 64 |
| ➔ PC Health Status .....                       | 64 |
| ➔ Console Redirection .....                    | 65 |
| ➔ Terminal Type [ANSI].....                    | 66 |
| ➔ Bits per second [115200].....                | 66 |
| ➔ Data Bits [8] .....                          | 67 |
| ➔ Parity [None].....                           | 67 |
| ➔ Stop Bits [1].....                           | 67 |
| ➔ Auto Recovery Function [Disabled].....       | 68 |
| ➔ Memory Information .....                     | 70 |
| ➔ IGFX - Boot Type [VBIOS Default] .....       | 71 |
| ➔ Fixed Graphics Memory Size [128 MB].....     | 71 |
| ➔ Bootup NumLock State [On].....               | 72 |
| ➔ Quiet Boot [Enabled] .....                   | 73 |
| ➔ Launch PXE OpROM [Disabled] .....            | 73 |
| ➔ Option ROM Messages [Force BIOS].....        | 73 |
| ➔ UEFI Boot [Disabled] .....                   | 74 |
| ➔ Boot Option Priority.....                    | 74 |
| ➔ Hard Drive BBS Priorities.....               | 74 |

|                                   |    |
|-----------------------------------|----|
| ➔ Administrator Password .....    | 75 |
| ➔ User Password .....             | 75 |
| ➔ Set User Password .....         | 76 |
| ➔ Save Changes and Reset .....    | 77 |
| ➔ Discard Changes and Reset ..... | 77 |
| ➔ Restore Defaults .....          | 77 |
| ➔ Save as User Defaults .....     | 78 |
| ➔ Restore User Defaults .....     | 78 |

Appendix

C

# One Key Recovery

---

## C.1 One Key Recovery Introduction

The IEI one key recovery is an easy-to-use front end for the Norton Ghost system backup and recovery tool. This tool provides quick and easy shortcuts for creating a backup and reverting to that backup or reverting to the factory default settings.



### NOTE:

The latest One Key Recovery software provides an auto recovery function that allows a system running Microsoft Windows OS to automatically restore from the factory default image after encountering a Blue Screen of Death (BSoD) or a hang for around 10 minutes. Please refer to Section C.3 for the detailed setup procedure.

The IEI One Key Recovery tool menu is shown below.

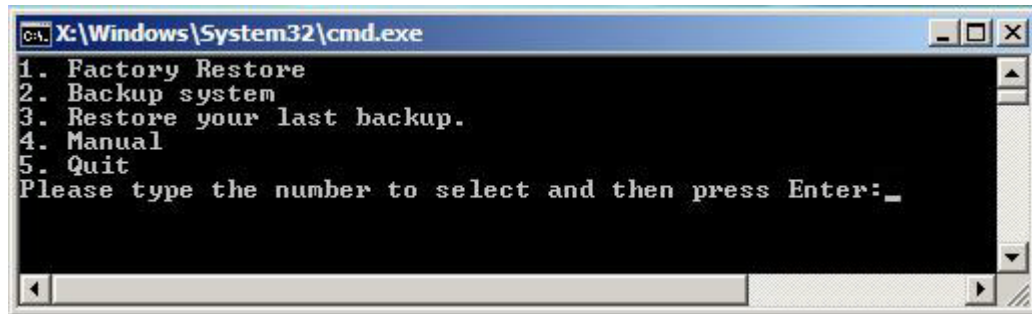

```
C:\X:\Windows\System32\cmd.exe
1. Factory Restore
2. Backup system
3. Restore your last backup.
4. Manual
5. Quit
Please type the number to select and then press Enter: _
```

Figure C-1: IEI One Key Recovery Tool Menu

Prior to using the IEI One Key Recovery tool (as shown in **Figure C-1**) to backup or restore Windows system, five setup procedures are required.

1. Hardware and BIOS setup (see **Section C.2.1**)
2. Create partitions (see **Section C.2.2**)
3. Install operating system, drivers and system applications (see **Section C.2.3**)
4. Build the recovery partition (see **Section C.2.4**)
5. Create factory default image (see **Section C.2.5**)

## uIBX-210-CV-N2600 Embedded System

After completing the five initial setup procedures as described above, users can access the recovery tool by pressing <F3> while booting up the system. The detailed information of each function is described in **Section C.5**.



### NOTE:

The initial setup procedures for Linux system are described in **Section C.3**.

---

### C.1.1 System Requirement

---



### NOTE:

The recovery CD can only be used with IEI products. The software will fail to run and a warning message will appear when used on non-IEI hardware.

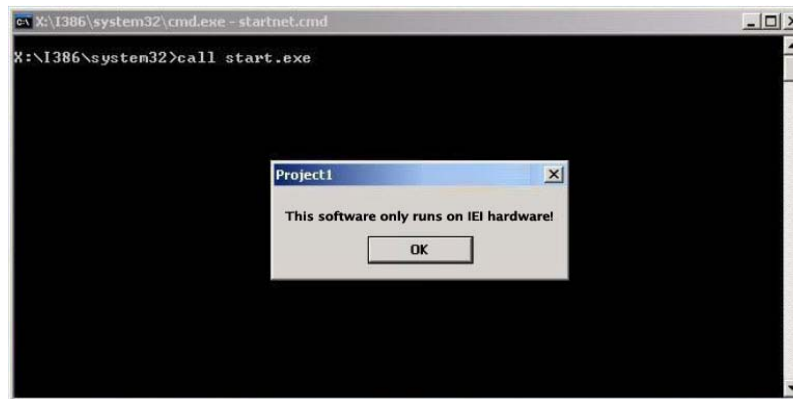

---

To create the system backup, the main storage device must be split into two partitions (three partitions for Linux). The first partition will be for the operating system, while the second partition will be invisible to the operating system and contain the backup made by the one key recovery software.

The partition created for recovery images must be big enough to contain both the factory default image and the user backup image. The size must be calculated before creating the

partitions. Please take the following table as a reference when calculating the size of the partition.

|                        | OS     | OS Image after Ghost | Compression Ratio |
|------------------------|--------|----------------------|-------------------|
| <b>Windows® 7</b>      | 7 GB   | 5 GB                 | 70%               |
| <b>Windows® XPE</b>    | 776 MB | 560 MB               | 70%               |
| <b>Windows® CE 6.0</b> | 36 MB  | 28 MB                | 77%               |

**NOTE:**

Specialized tools are required to change the partition size if the operating system is already installed.

### C.1.2 Supported Operating System

The recovery CD is compatible with both Microsoft Windows and Linux operating systems (OS). The supported OS versions are listed below.

- Microsoft Windows
  - Windows XP (Service Pack 2 or 3 required)
  - Windows Vista
  - Windows 7
  - Windows CE 5.0
  - Windows CE 6.0
  - Windows XP Embedded
- Linux
  - Fedora Core 12 (Constantine)
  - Fedora Core 11 (Leonidas)
  - Fedora Core 10 (Cambridge)
  - Fedora Core 8 (Werewolf)
  - Fedora Core 7 (Moonshine)
  - RedHat RHEL-5.4
  - RedHat 9 (Ghirke)

- Ubuntu 8.10 (Intrepid)
- Ubuntu 7.10 (Gutsy)
- Ubuntu 6.10 (Edgy)
- Debian 5.0 (Lenny)
- Debian 4.0 (Etch)
- SuSe 11.2
- SuSe 10.3

**NOTE:**

Installing unsupported OS versions may cause the recovery tool to fail.

---

## C.2 Setup Procedure for Windows

Prior to using the recovery tool to backup or restore, a few setup procedures are required.

**Step 1:** Hardware and BIOS setup (see **Section C.2.1**)

**Step 2:** Create partitions (see **Section C.2.2**)

**Step 3:** Install operating system, drivers and system applications (see **Section C.2.3**)

**Step 4:** Build the recovery partition (see **Section C.2.4**) or build the auto recovery partition (see **Section C.3**)

**Step 5:** Create factory default image (see **Section C.2.5**)

The detailed descriptions are described in the following sections.

---

**NOTE:**

The setup procedures described below are for Microsoft Windows operating system users. For Linux, most of the setup procedures are the same except for several steps described in **Section C.3**.

---



### C.2.1 Hardware and BIOS Setup

- Step 1:** Make sure the system is powered off and unplugged.
- Step 2:** Install a hard drive or SSD in the system. An unformatted and unpartitioned disk is recommended.
- Step 3:** Connect an optical disk drive to the system and insert the recovery CD.
- Step 4:** Turn on the system.
- Step 5:** Press the <DELETE> key as soon as the system is turned on to enter the BIOS.
- Step 6:** Select the connected optical disk drive as the 1<sup>st</sup> boot device. (**Boot → Boot Device Priority → 1<sup>st</sup> Boot Device**).
- Step 7:** Save changes and restart the computer. Continue to the next section for instructions on partitioning the internal storage.

### C.2.2 Create Partitions

To create the system backup, the main storage device must be split into two partitions (three partitions for Linux). The first partition will be for the operating system, while the second partition will be invisible to the operating system and contain the backup made by the one key recovery software.

- Step 1:** Put the recovery CD in the optical drive of the system.
- Step 2:** **Boot the system from recovery CD.** When prompted, press any key to boot from the recovery CD. It will take a while to launch the recovery tool. Please be patient!

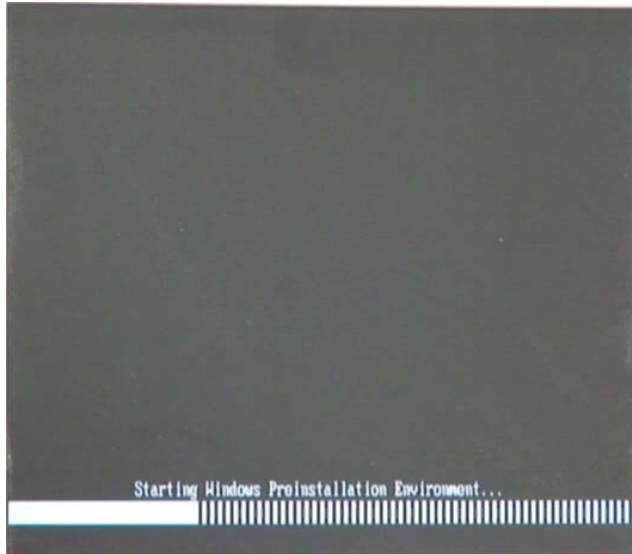

Figure C-2: Launching the Recovery Tool

Step 3: The recovery tool setup menu is shown as below.

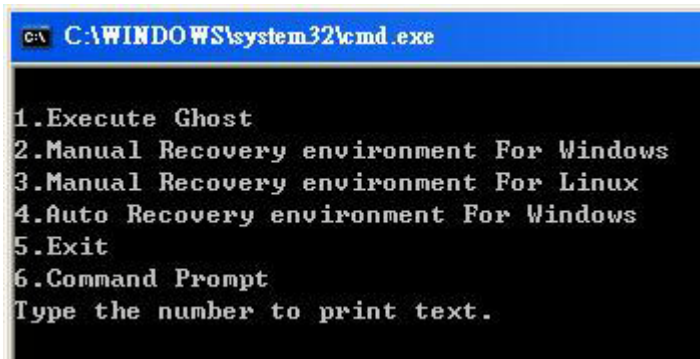
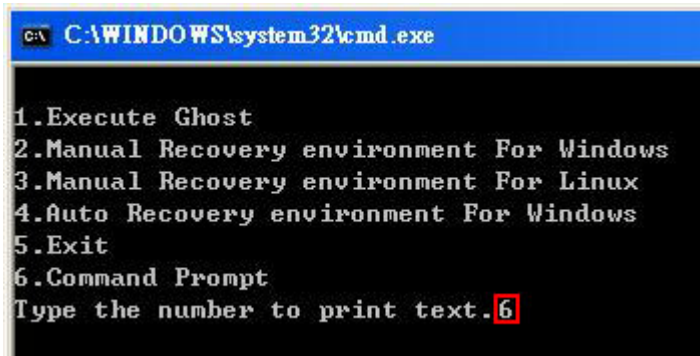

Figure C-3: Recovery Tool Setup Menu

Step 4: Press <6> then <Enter>.



```

C:\WINDOWS\system32\cmd.exe

1.Execute Ghost
2.Manual Recovery environment For Windows
3.Manual Recovery environment For Linux
4.Auto Recovery environment For Windows
5.Exit
6.Command Prompt
Type the number to print text.6
  
```

Figure C-4: Command Prompt

**Step 5:** The command prompt window appears. Type the following commands (marked in red) to create two partitions. One is for the OS installation; the other is for saving recovery files and images which will be an invisible partition. (Press <Enter> after entering each line below)

```

system32>diskpart
DISKPART>list vol
DISKPART>sel disk 0
DISKPART>create part pri size= ____
DISKPART>assign letter=N
DISKPART>create part pri size= ____
DISKPART>assign letter=F
DISKPART>exit
system32>format N: /fs:ntfs /q /y
system32>format F: /fs:ntfs /q /v:Recovery /y
system32>exit
  
```

```

X:\I386\SYSTEM32\CMD.EXE
X:\I386\SYSTEM32>diskpart → Starts the Microsoft disk partitioning tool.

Microsoft DiskPart version 5.2.3790.1830
Copyright (C) 1999-2001 Microsoft Corporation.
On computer: MININT-JUC

DISKPART> list vol → Show partition information

   Volume ###  Ltr  Label          Fs      Type          Size      Status       Info
   -----
   Volume 0          X  CD_ROM         CDFS    DUD-ROM       405 MB    Healthy      Boot
   Volume 1          D                FAT32    Removeable   3854 MB    Healthy

DISKPART> sel disk 0 → Select a disk
Disk 0 is now the selected disk.

DISKPART> create part pri size=2000 → Create partition 1 and assign a size.
                                     This partition is for OS installation.
DiskPart succeeded in creating the specified partition.

DISKPART> assign letter=N → Assign partition 1 a code name (N).
DiskPart successfully assigned the drive letter or mount point.

DISKPART> create part pri size=1800 → Create partition 2 and assign a size.
                                     This partition is for recovery images.
DiskPart succeeded in creating the specified partition.

DISKPART> assign letter=F → Assign partition 2 a code name (F).
DiskPart successfully assigned the drive letter or mount point.

DISKPART> exit → Exit diskpart

X:\I386\SYSTEM32>format n: /fs:ntfs /q /y → Format partition 1 (N) as NTFS format.
The type of the file system is RAW.
The new file system is NTFS.
QuickFormatting 2000M
Creating file system structures.
Format complete.
 2048254 KB total disk space.
 2035620 KB are available.

X:\I386\SYSTEM32>format f: /fs:ntfs /q /v:Recovery /y
The type of the file system is RAW.
The new file system is NTFS.
QuickFormatting 1804M
Creating file system structures.
Format complete.
 1847474 KB total disk space.
 1835860 KB are available.

X:\I386\SYSTEM32>exit → Exit Windows PE
  
```

Figure C-5: Partition Creation Commands

**NOTE:**

Use the following commands to check if the partitions were created successfully.

```

X:\I386\SYSTEM32>diskpart
Microsoft DiskPart version 5.2.3790.1830
Copyright (C) 1999-2001 Microsoft Corporation.
On computer: MININT-JUC
DISKPART> sel disk 0
Disk 0 is now the selected disk.
DISKPART> list part
   Partition ###  Type              Size              Offset
-----
Partition 1      Primary           2000 MB           32 KB
Partition 2      Primary           1804 MB          2000 MB
DISKPART> exit
    
```

**Step 6:** Press any key to exit the recovery tool and automatically reboot the system.

Please continue to the following procedure: Build the Recovery Partition.

### C.2.3 Install Operating System, Drivers and Applications

Install the operating system onto the unlabelled partition. The partition labeled "Recovery" is for use by the system recovery tool and should not be used for installing the operating system or any applications.

**NOTE:**

The operating system installation program may offer to reformat the chosen partition. DO NOT format the partition again. The partition has already been formatted and is ready for installing the new operating system.

To install the operating system, insert the operating system installation CD into the optical drive. Restart the computer and follow the installation instructions.

### C.2.4 Building the Recovery Partition

- Step 1:** Put the recover CD in the optical drive.
- Step 2:** Start the system.
- Step 3:** **Boot the system from the recovery CD.** When prompted, press any key to boot from the recovery CD. It will take a while to launch the recovery tool. Please be patient!

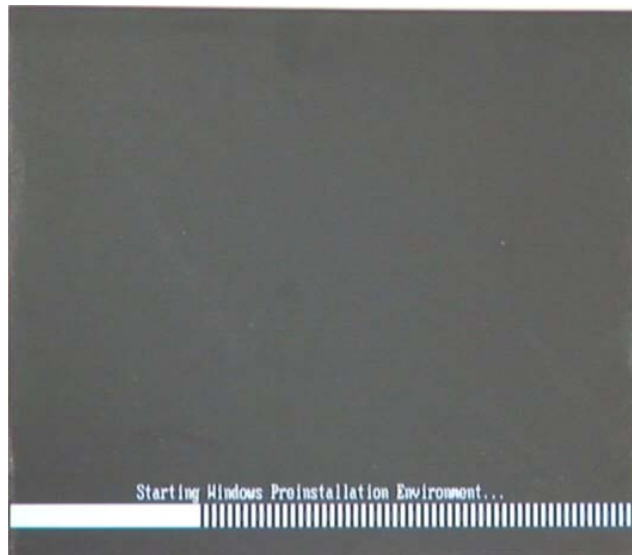

Figure C-6: Launching the Recovery Tool

- Step 4:** When the recovery tool setup menu appears, press <2> then <Enter>.

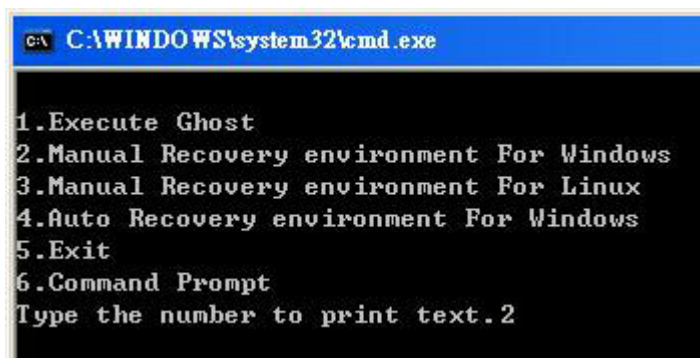
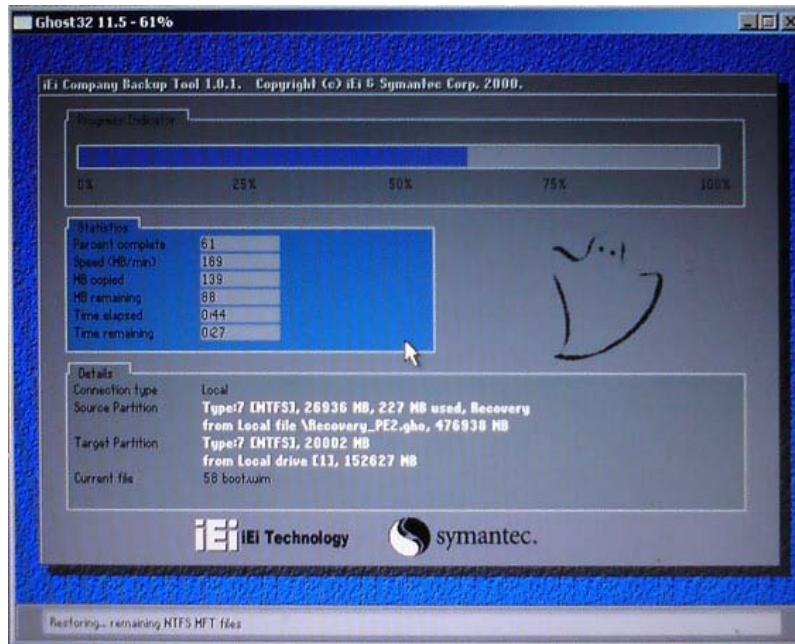

Figure C-7: Manual Recovery Environment for Windows

**Step 5:** The Symantec Ghost window appears and starts configuring the system to build a recovery partition. In this process the partition created for recovery files in **Section C.2.2** is hidden and the recovery tool is saved in this partition.



**Figure C-8: Building the Recovery Partition**

**Step 6:** After completing the system configuration, press any key in the following window to reboot the system.

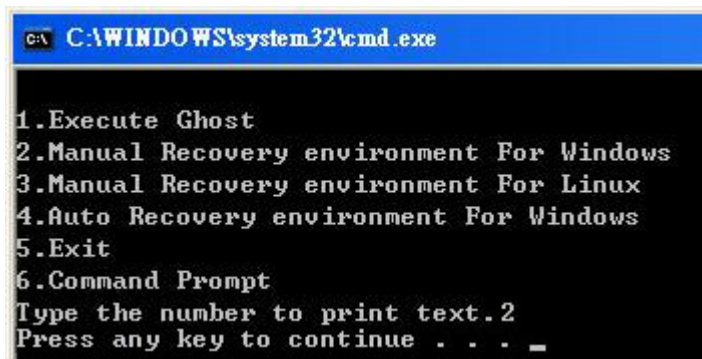

**Figure C-9: Press Any Key to Continue**

**Step 7:** Eject the recovery CD.

### C.2.5 Create Factory Default Image



#### NOTE:

Before creating the factory default image, please configure the system to a factory default environment, including driver and application installations.

To create a factory default image, please follow the steps below.

**Step 1:** Turn on the system. When the following screen displays (**Figure C-10**), press the <F3> key to access the recovery tool. The message will display for 10 seconds, please press F3 before the system boots into the operating system.

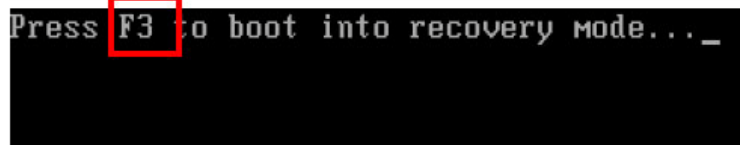

**Figure C-10: Press F3 to Boot into Recovery Mode**

**Step 2:** The recovery tool menu appears. Type <4> and press <Enter>. (**Figure C-11**)

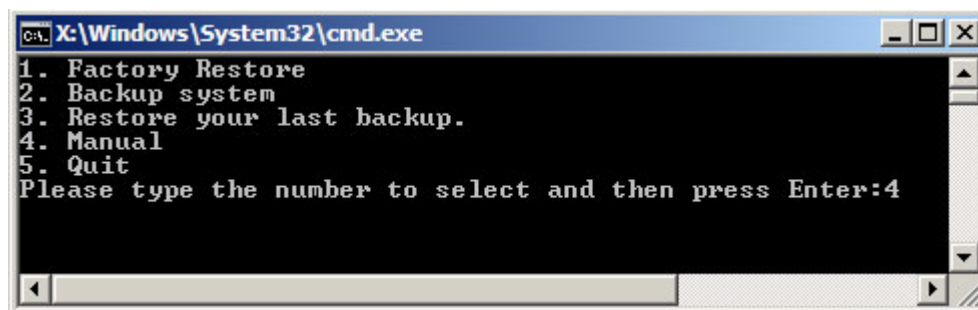

**Figure C-11: Recovery Tool Menu**

**Step 3:** The About Symantec Ghost window appears. Click **OK** button to continue.



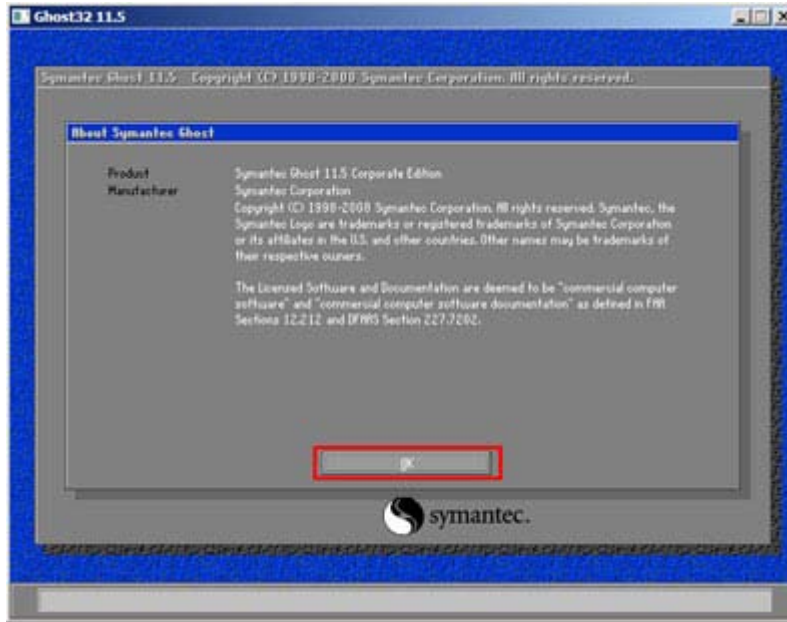

Figure C-12: About Symantec Ghost Window

Step 4: Use mouse to navigate to the option shown below (Figure C-13).

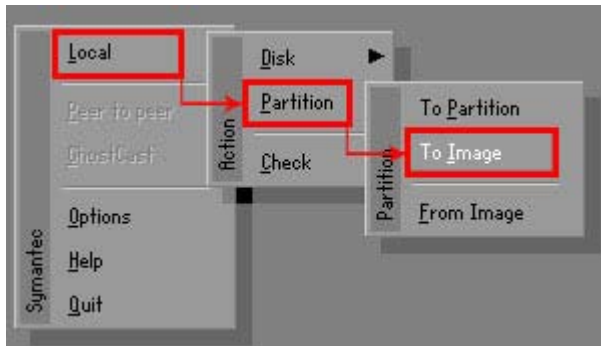

Figure C-13: Symantec Ghost Path

Step 5: Select the local source drive (Drive 1) as shown in Figure C-14. Then click OK.

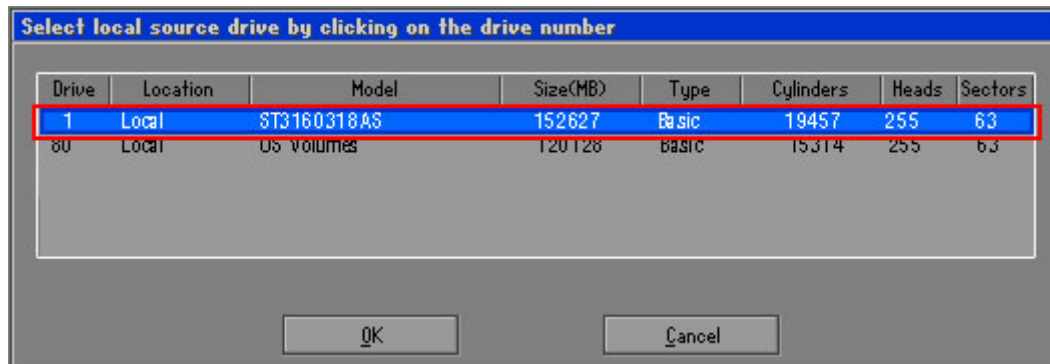

Figure C-14: Select a Local Source Drive

Step 6: Select a source partition (Part 1) from basic drive as shown in **Figure C-15**. Then click OK.

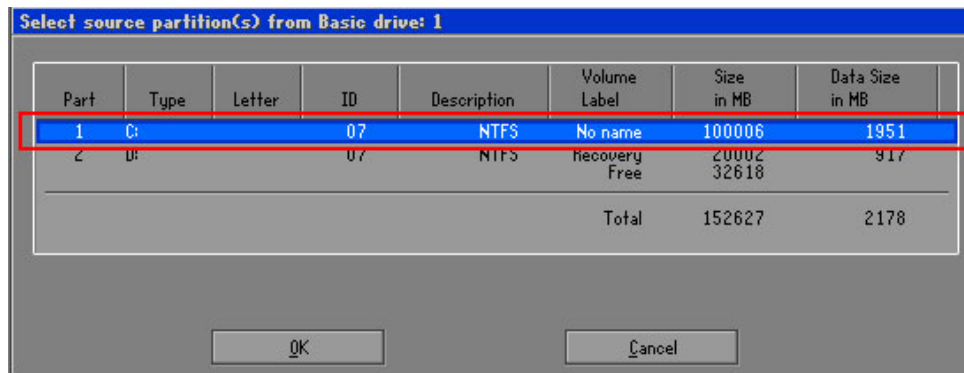

Figure C-15: Select a Source Partition from Basic Drive

Step 7: Select **1.2: [Recovery] NTFS drive** and enter a file name called **iei** (**Figure C-16**). Click **Save**. The factory default image will then be saved in the selected recovery drive and named **IEI.GHO**.



**WARNING:**

The file name of the factory default image must be **iei.GHO**.

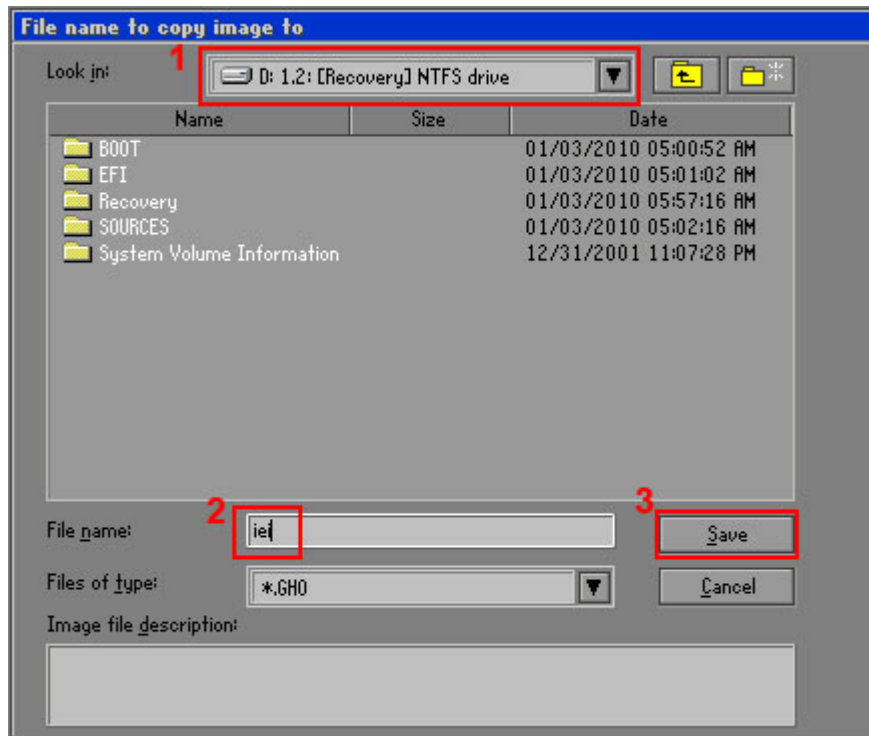

Figure C-16: File Name to Copy Image to

**Step 8:** When the Compress Image screen in **Figure C-17** prompts, click **High** to make the image file smaller.

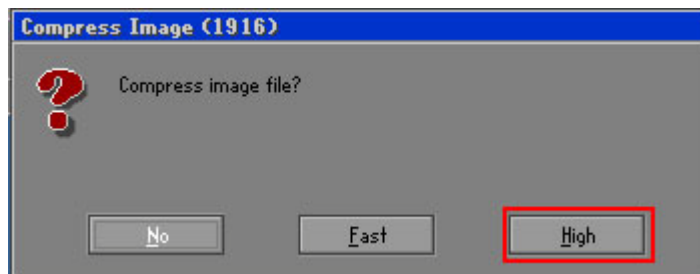
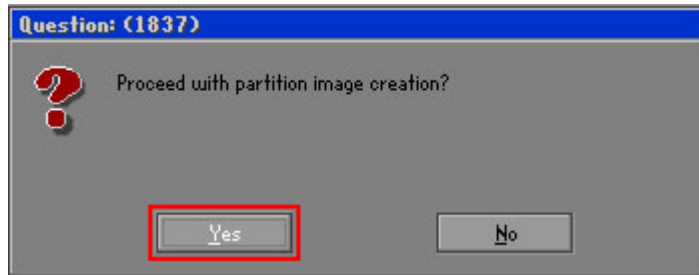

Figure C-17: Compress Image

**Step 9:** The Proceed with partition image creation window appears, click **Yes** to continue.



**Figure C-18: Image Creation Confirmation**

**Step 10:** The Symantec Ghost starts to create the factory default image (**Figure C-19**).

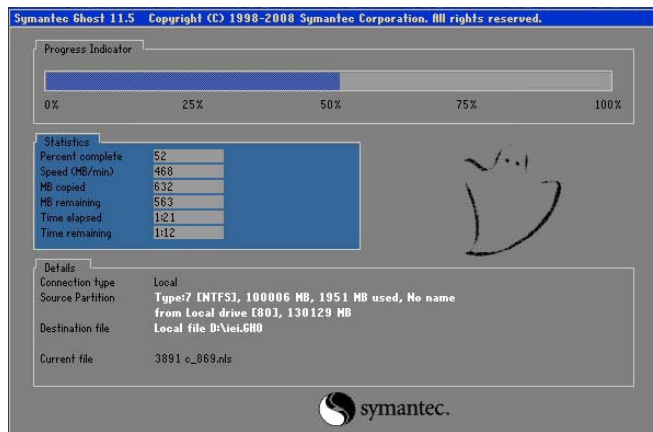

**Figure C-19: Image Creation Complete**

**Step 11:** When the image creation completes, a screen prompts as shown in **Figure C-20**.

Click **Continue** and close the Ghost window to exit the program.

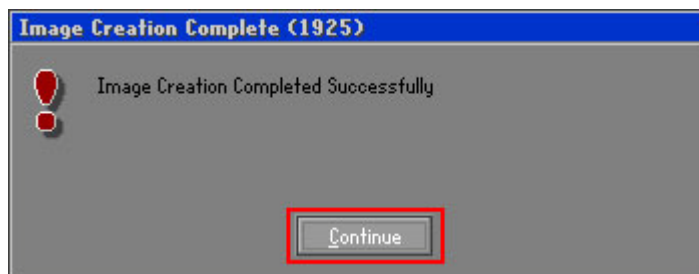

**Figure C-20: Image Creation Complete**

**Step 12:** The recovery tool main menu window is shown as below. Press any key to reboot the system.

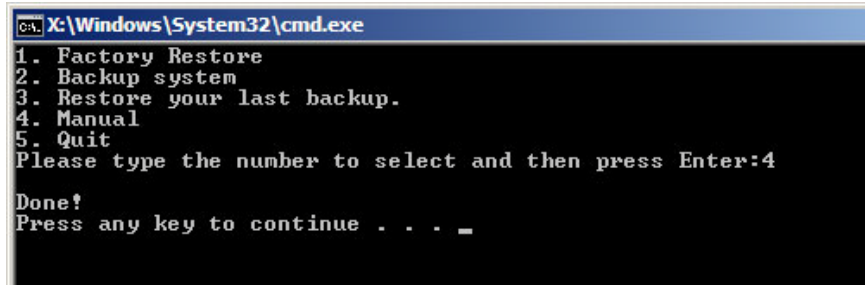

```

C:\Windows\System32\cmd.exe
1. Factory Restore
2. Backup system
3. Restore your last backup.
4. Manual
5. Quit
Please type the number to select and then press Enter:4
Done!
Press any key to continue . . . _
    
```

**Figure C-21: Press Any Key to Continue**

### C.3 Auto Recovery Setup Procedure

The auto recovery function allows a system to automatically restore from the factory default image after encountering a Blue Screen of Death (BSoD) or a hang for around 10 minutes. To use the auto recovery function, follow the steps described in the following sections.



#### **CAUTION:**

The setup procedure may include a step to create a factory default image. It is suggested to configure the system to a factory default environment before the configuration, including driver and application installations.

**Step 1:** Follow the steps described in **Section C.2.1 ~ Section C.2.3** to setup BIOS, create partitions and install operating system.

**Step 2:** Install the auto recovery utility into the system by double clicking the **Utility/AUTORECOVERY-SETUP.exe** in the One Key Recovery CD. This utility **MUST** be installed in the system, otherwise, the system will automatically restore from the factory default image every ten (10) minutes.



Figure C-22: Auto Recovery Utility

**Step 3:** Reboot the system from the recovery CD. When prompted, press any key to boot from the recovery CD. It will take a while to launch the recovery tool. Please be patient!

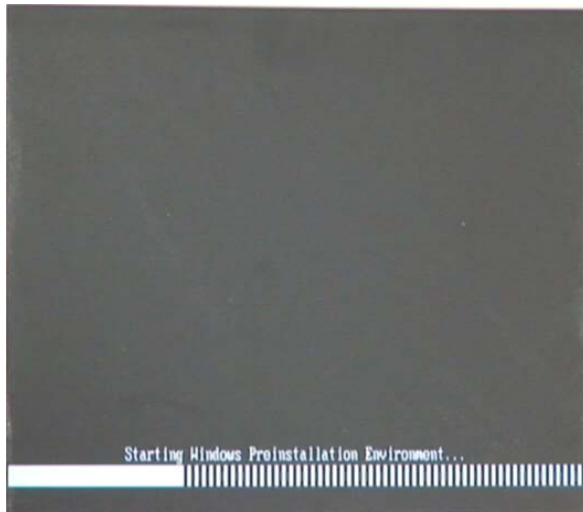

Figure C-23: Launching the Recovery Tool

**Step 4:** When the recovery tool setup menu appears, press <4> then <Enter>.

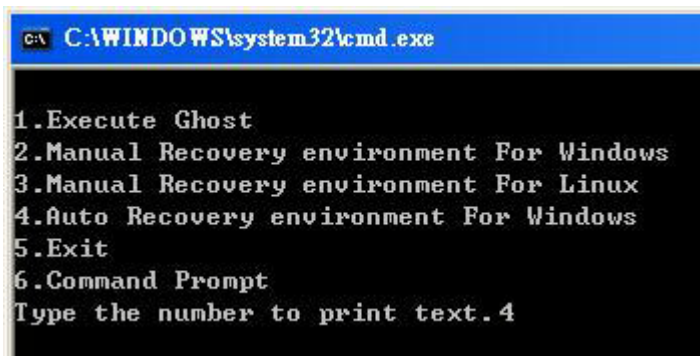
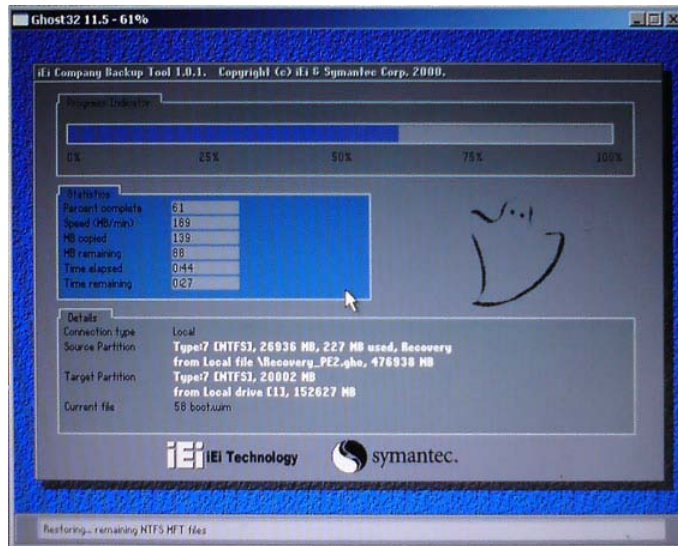

Figure C-24: Auto Recovery Environment for Windows

**Step 5:** The Symantec Ghost window appears and starts configuring the system to build an auto recovery partition. In this process the partition created for recovery files in **Section C.2.2** is hidden and the auto recovery tool is saved in this partition.



**Figure C-25: Building the Auto Recovery Partition**

**Step 6:** After completing the system configuration, the following message prompts to confirm whether to create a factory default image. Type **Y** to have the system create a factory default image automatically. Type **N** within 6 seconds to skip this process (The default option is YES). It is suggested to choose YES for this option.



**Figure C-26: Factory Default Image Confirmation**

**Step 7:** The Symantec Ghost starts to create the factory default image (**Figure C-27**).

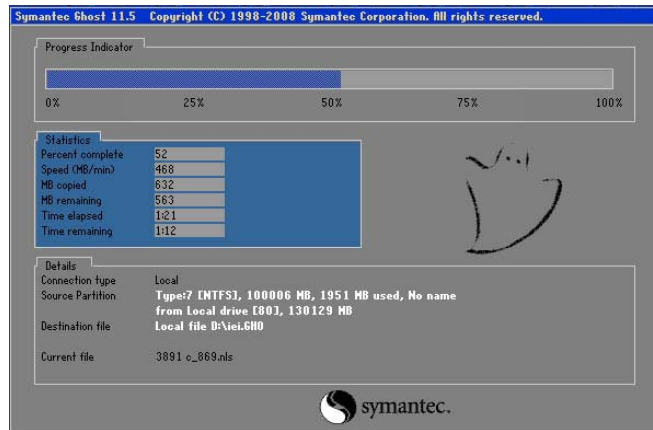

**Figure C-27: Image Creation Complete**

**Step 8:** After completing the system configuration, press any key in the following window to restart the system.

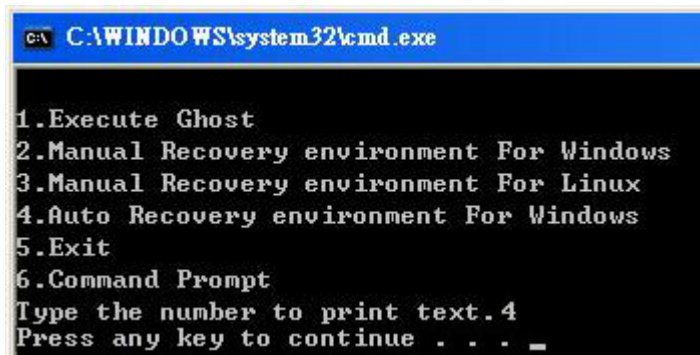

**Figure C-28: Press any key to continue**

**Step 9:** Eject the One Key Recovery CD and restart the system.

**Step 10:** Press the <DELETE> key as soon as the system is turned on to enter the BIOS.

**Step 11:** Enable the Auto Recovery Function option (**Advanced** → **iEi Feature** → **Auto Recovery Function**).



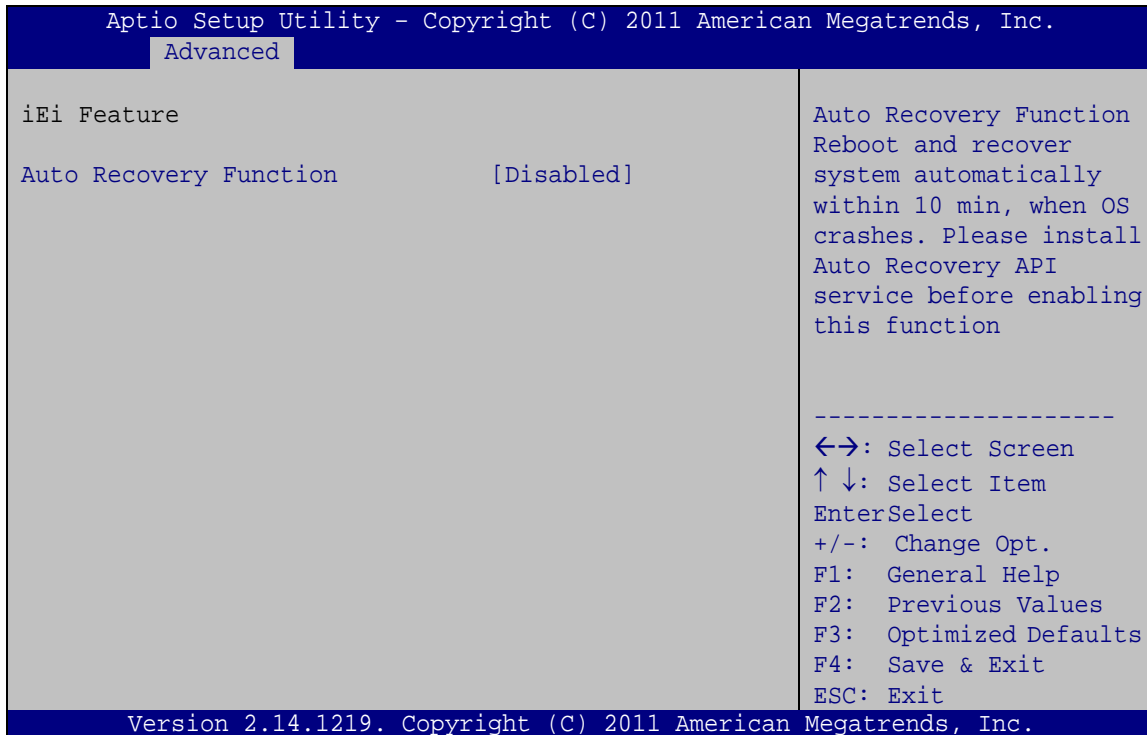

#### BIOS Menu 22: iEi Feature

**Step 12:** Save changes and restart the system. If the system encounters a Blue Screen of Death (BSoD) or a hang for around 10 minutes, it will automatically restore from the factory default image.



#### CAUTION:

The auto recovery function can only apply on a Microsoft Windows system running the following OS versions:

- Windows XP
- Windows Vista
- Windows 7

## C.4 Setup Procedure for Linux

The initial setup procedure for Linux system is mostly the same with the procedure for Microsoft Windows. Please follow the steps below to setup recovery tool for Linux OS.

**Step 1: Hardware and BIOS setup.** Refer to **Section C.2.1**.

**Step 2: Install Linux operating system.** Make sure to install GRUB (v0.97 or earlier) MBR type and Ext3 partition type. Leave enough space on the hard drive to create the recover partition later.



### NOTE:

If the Linux OS is not installed with GRUB (v0.97 or earlier) and Ext3, the Symantec Ghost may not function properly.

While installing Linux OS, please create two partitions:

- Partition 1: /
- Partition 2: **SWAP**



### NOTE:

Please reserve enough space for partition 3 for saving recovery images.

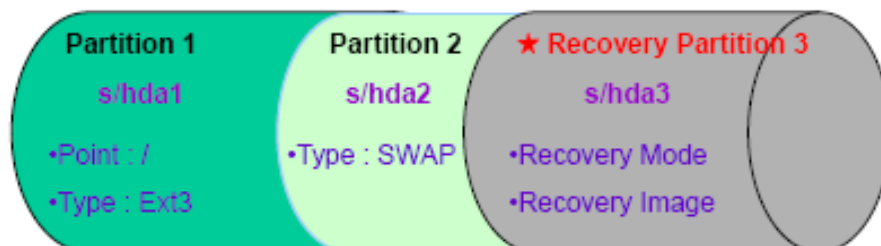

Figure C-29: Partitions for Linux

**Step 3: Create a recovery partition.** Insert the recovery CD into the optical disk drive.

Follow **Step 1 ~ Step 3** described in **Section C.2.2**. Then type the following commands (marked in red) to create a partition for recovery images.

```

system32>diskpart
DISKPART>list vol
DISKPART>sel disk 0
DISKPART>create part pri size= ____
DISKPART>assign letter=N
DISKPART>exit
system32>format N: /fs:ntfs /q /v:Recovery /y
system32>exit
  
```

**Step 4: Build the recovery partition.** Press any key to boot from the recovery CD. It will take a while to launch the recovery tool. Please be patient. When the recovery tool setup menu appears, type <3> and press <Enter> (**Figure C-30**). The Symantec Ghost window appears and starts configuring the system to build a recovery partition. After completing the system configuration, press any key to reboot the system. Eject the recovery CD.

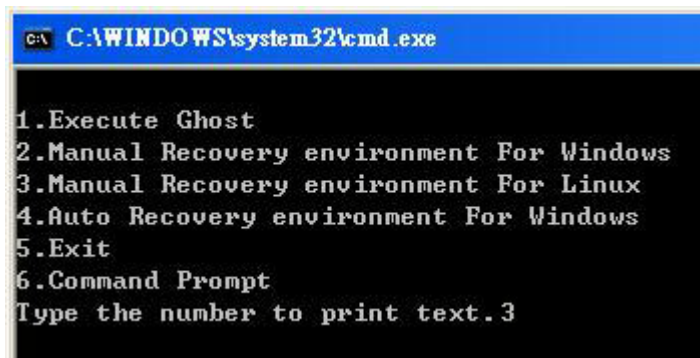

```

C:\WINDOWS\system32\cmd.exe
1.Execute Ghost
2.Manual Recovery environment For Windows
3.Manual Recovery environment For Linux
4.Auto Recovery environment For Windows
5.Exit
6.Command Prompt
Type the number to print text.3
  
```

**Figure C-30: Manual Recovery Environment for Linux**

**Step 5: Access the recovery tool main menu by modifying the “menu.lst”.** To first access the recovery tool main menu, the menu.lst must be modified. In Linux, enter Administrator (root). When prompt appears, type:

**cd /boot/grub**

**vi menu.lst**

```
Fedora release 9 (Sulphur)
Kernel 2.6.25-14.fc9.i686 on an i686 (tty2)

localhost login: root
Password:
[root@localhost ~]# cd /boot/grub/
[root@localhost grub]# vi menu.lst _
```

**Figure C-31: Access menu.lst in Linux (Text Mode)**

**Step 6:** Modify the menu.lst as shown below.

```
#boot=/dev/sda
default=0
timeout=10 ← Modify timeout=10
splashimage=(hd0,0)/grub/splash.xpm.gz
hiddenmenu
title Fedora (2.6.25-14.fc9.i686)
    root (hd0,0)
    kernel /vmlinuz-2.6.25-14.fc9.i686 ro root=UUID=10f1acd
ac38b5c78910 rhgb quiet
    initrd /initrd-2.6.25-14.fc9.i686.img

title Recovery Partition
root (hd0,2)
makeactive ← Type command
chainloader +1
```

- **Type command:**  
**title Recovery Partition**  
**root (hd0,2)**  
**makeactive**  
**chainloader +1**

**Step 7:** The recovery tool menu appears. (**Figure C-32**)

```
1. Factory Restore
2. Backup system
3. Restore your last backup.
4. Manual
5. Quit
Please type the number to select and then press Enter:
```

**Figure C-32: Recovery Tool Menu**

**Step 8:** Create a factory default image. Follow **Step 2 ~ Step 12** described in **Section C.2.5** to create a factory default image.

## C.5 Recovery Tool Functions

After completing the initial setup procedures as described above, users can access the recovery tool by pressing <F3> while booting up the system. However, if the setup procedure in Section C.3 has been completed and the auto recovery function is enabled, the system will automatically restore from the factory default image without pressing the F3 key. The recovery tool main menu is shown below.

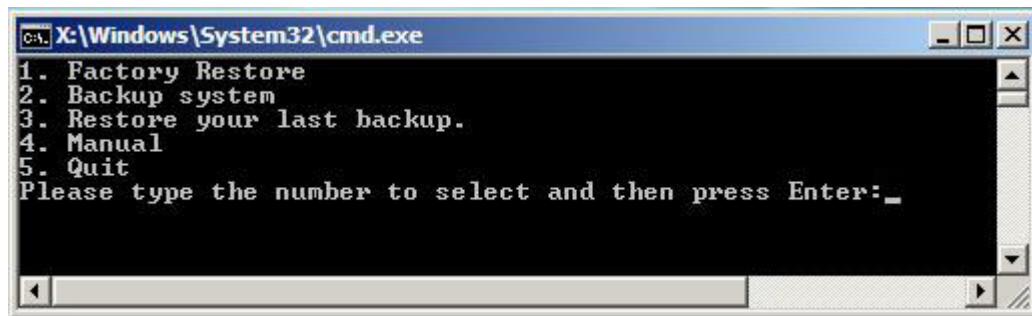

**Figure C-33: Recovery Tool Main Menu**

The recovery tool has several functions including:

1. **Factory Restore:** Restore the factory default image (iei.GHO) created in Section C.2.5.
2. **Backup system:** Create a system backup image (iei\_user.GHO) which will be saved in the hidden partition.
3. **Restore your last backup:** Restore the last system backup image
4. **Manual:** Enter the Symantec Ghost window to configure manually.
5. **Quit:** Exit the recovery tool and restart the system.



### **WARNING:**

Please do not turn off the system power during the process of system recovery or backup.



**WARNING:**

All data in the system will be deleted during the system recovery. Please backup the system files before restoring the system (either Factory Restore or Restore Backup).

### C.5.1 Factory Restore

To restore the factory default image, please follow the steps below.

**Step 1:** Type <1> and press <Enter> in the main menu.

**Step 2:** The Symantec Ghost window appears and starts to restore the factory default. A factory default image called **iei.GHO** is created in the hidden Recovery partition.

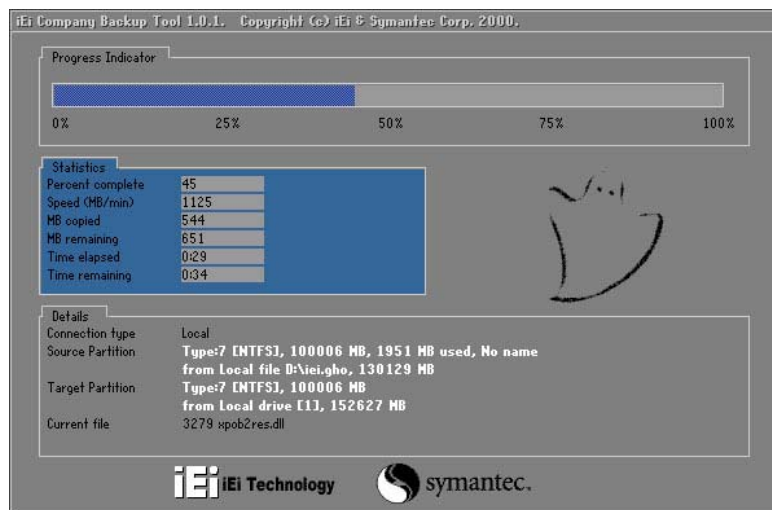

**Figure C-34: Restore Factory Default**

**Step 3:** The screen shown in **Figure C-35** appears when completed. Press any key to reboot the system.

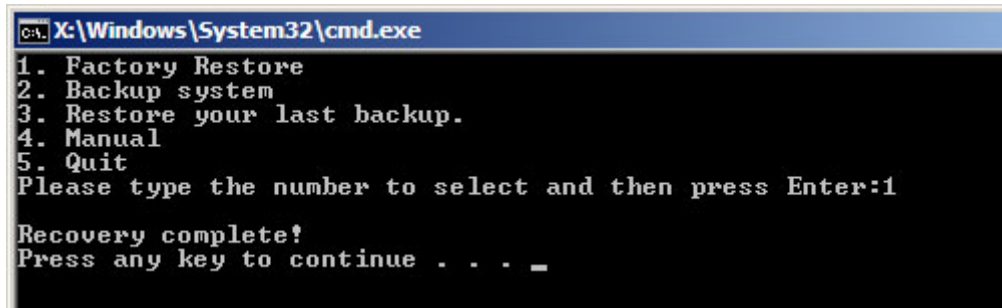

**Figure C-35: Recovery Complete Window**

## C.5.2 Backup System

To backup the system, please follow the steps below.

**Step 1:** Type <2> and press <Enter> in the main menu.

**Step 2:** The Symantec Ghost window appears and starts to backup the system. A backup image called **iei\_user.GHO** is created in the hidden Recovery partition.

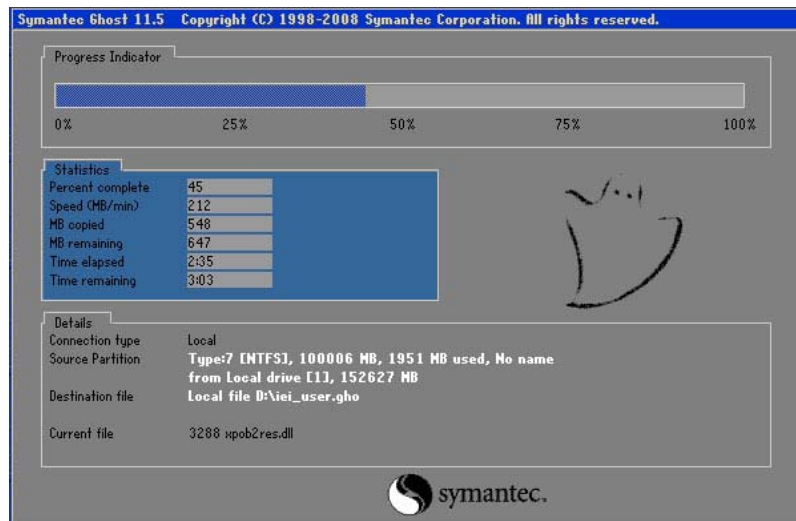

**Figure C-36: Backup System**

**Step 3:** The screen shown in **Figure C-37** appears when system backup is complete. Press any key to reboot the system.

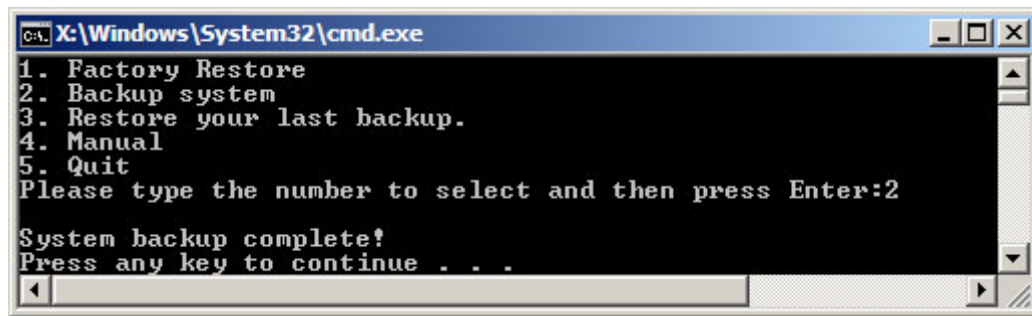

Figure C-37: System Backup Complete Window

### C.5.3 Restore Your Last Backup

To restore the last system backup, please follow the steps below.

**Step 1:** Type <3> and press <Enter> in the main menu.

**Step 2:** The Symantec Ghost window appears and starts to restore the last backup image (iei\_user.GHO).

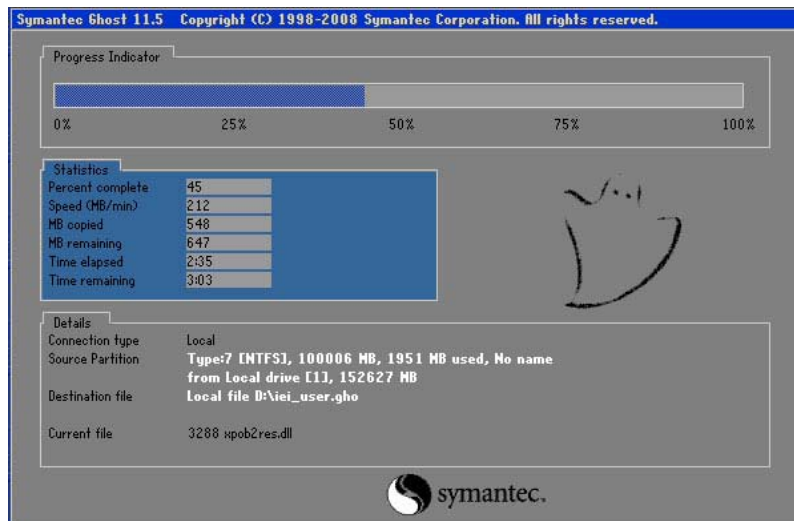
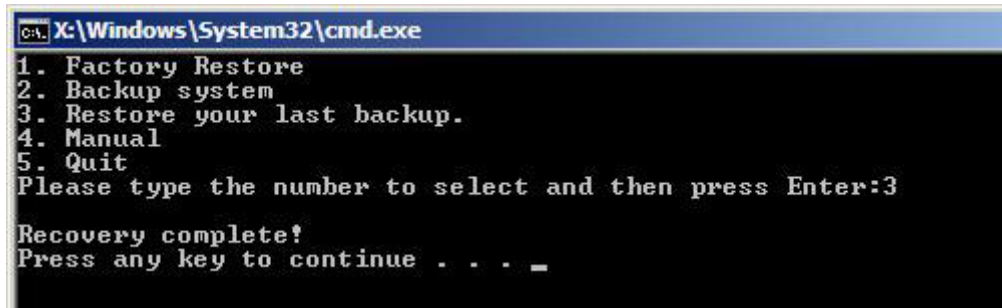

Figure C-38: Restore Backup

**Step 3:** The screen shown in **Figure C-39** appears when backup recovery is complete. Press any key to reboot the system.





**Figure C-39: Restore System Backup Complete Window**

#### C.5.4 Manual

To restore the last system backup, please follow the steps below.

**Step 1:** Type <4> and press <Enter> in the main menu.

**Step 2:** The Symantec Ghost window appears. Use the Ghost program to backup or recover the system manually.

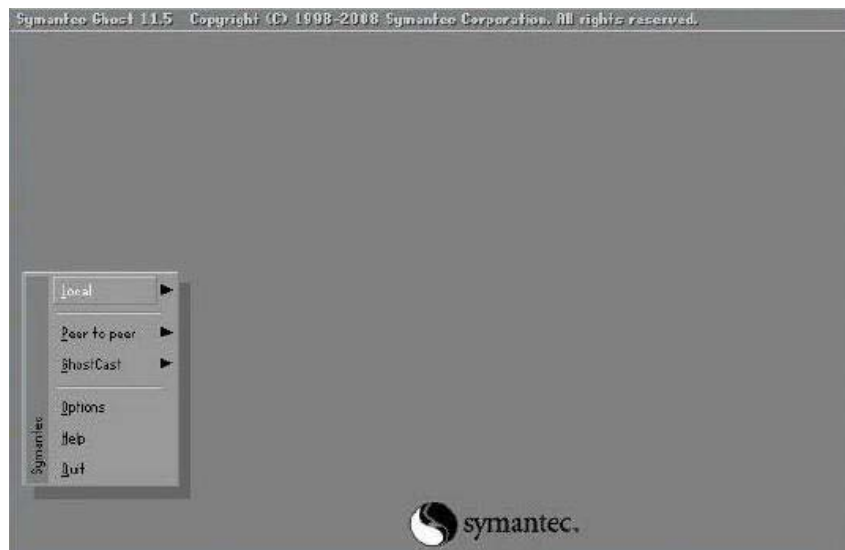
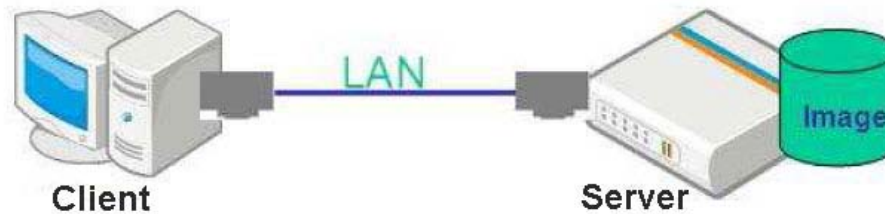

**Figure C-40: Symantec Ghost Window**

**Step 3:** When backup or recovery is completed, press any key to reboot the system.

## C.6 Restore Systems from a Linux Server through LAN

The One Key Recovery allows a client system to automatically restore to a factory default image saved in a Linux system (the server) through LAN connectivity after encountering a Blue Screen of Death (BSoD) or a hang for around 10 minutes. To be able to use this function, the client system and the Linux system MUST reside in the same domain.



### NOTE:

The supported client OS includes:

- Windows 2000
- Windows XP
- Windows Vista
- Windows 7
- Windows CE
- Windows XP Embedded

Prior to restoring client systems from a Linux server, a few setup procedures are required.

**Step 1:** Configure DHCP server settings

**Step 2:** Configure TFTP settings

**Step 3:** Configure One Key Recovery server settings

**Step 4:** Start DHCP, TFTP and HTTP

**Step 5:** Create a shared directory

**Step 6:** Setup a client system for auto recovery

The detailed descriptions are described in the following sections. In this document, two types of Linux OS are used as examples to explain the configuration process – CentOS 5.5 (Kernel 2.6.18) and Debian 5.0.7 (Kernel 2.6.26).

## C.6.1 Configure DHCP Server Settings

**Step 1:** Install the DHCP

`#yum install dhcp` (CentOS, commands marked in red)

`#apt-get install dhcp3-server` (Debian, commands marked in blue)

**Step 2:** Confirm the operating system default settings: dhcpd.conf.

### CentOS

Use the following command to show the DHCP server sample location:

`#vi /etc/dhcpd.conf`

The DHCP server sample location is shown as below:

```
# DHCP Server Configuration file.
# see /usr/share/doc/dhcp*/dhcpd.conf.sample
#
```

Use the following command to copy the DHCP server sample to etc/dhcpd.conf:

`#cp /usr/share/doc/dhcp-3.0.5/dhcpd.conf.sample /etc/dhcpd.conf`

`#vi /etc/dhcpd.conf`

```
ddns-update-style interim;
ignore client-updates;

subnet 192.168.0.0 netmask 255.255.255.0 {
# --- default gateway
    option routers                192.168.0.2;
    option subnet-mask            255.255.255.0;

    option nis-domain             "domain.org";
    option domain-name            "domain.org";
    option domain-name-servers   192.168.0.1;
    next-server 192.168.0.6;
    filename "pxelinux.0";
    option time-offset            -18000; # Eastern Standard Time
    option ntp-servers            192.168.1.1;
}
```

### Debian

`#vi /etc/dhcpd.conf`

Edit “/etc/dhcpd.conf” for your environment. For example, add

`next-server PXE server IP address;`

filename "pxelinux.0";

```
ddns-update-style interim;
ignore client-updates;

subnet 192.168.0.0 netmask 255.255.255.0 {
# --- default gateway
    option routers                192.168.0.2;
    option subnet-mask            255.255.255.0;

    option nis-domain             "domain.org";
    option domain-name            "domain.org";
    option domain-name-servers   192.168.0.1;
    next-server 192.168.0.6;
    filename "pxelinux.0";
    option time-offset            -18000; # Eastern Standard Time
    option ntp-servers            192.168.1.1;
}
```

### C.6.2 Configure TFTP Settings

**Step 1:** Install the tftp, httpd and syslinux.

`#yum install tftp-server httpd syslinux` (CentOS)

`#apt-get install tftpd-hpa xinetd syslinux` (Debian)

**Step 2:** Enable the TFTP server by editing the "/etc/xinetd.d/tftp" file and make it use the remap file. The "-vvv" is optional but it could definitely help on getting more information while running the remap file. For example:

#### CentOS

`#vi /etc/xinetd.d/tftp`

Modify:

`disable = no`

`server_args = -s /tftpboot -m /tftpboot/tftpd.remap -vvv_`

```
socket_type      = dgram
protocol        = udp
wait            = yes
user            = root
server          = /usr/sbin/in.tftpd
server_args     = -s /tftpboot -m /tftpboot/tftpd.remap -vvv
disable         = no
per_source      = 11
cps             = 100 2
flags           = IPv4
```

### Debian

Replace the TFTP settings from “inetd” to “xinetd” and annotate the “inetd” by adding “#”.

`#vi /etc/inetd.conf`

Modify: `#tftp dgram udp wait root /usr/sbin.....` (as shown below)

```
#:BOOT: TFTP service is provided primarily for booting. Most sites
# run this only on machines acting as "boot servers."
#tftp dgram udp wait root /usr/sbin/in.tftpd /usr/sbin/in.tftpd -s
/var/lib/tftpboot
```

`#vi /etc/xinetd.d/tftp`

```
socket_type      = dgram
protocol        = udp
wait            = yes
user            = root
server          = /usr/sbin/in.tftpd
server_args     = -s /tftpboot -m /tftpboot/tftpd.remap -vvv
disable         = no
per_source      = 11
cps             = 100 2
flags           = IPv4
```

## C.6.3 Configure One Key Recovery Server Settings

**Step 1:** Copy the **Utility/RECOVERYR10.TAR.BZ2** package from the One Key Recovery CD to the system (server side).



**Step 2:** Extract the recovery package to /.

```
#cp RecoveryR10.tar.bz2 /
#cd /
#tar -xvzf RecoveryR10.tar.bz2
```

**Step 3:** Copy “pxelinux.0” from “syslinux” and install to “tftpboot”.

```
#cp /usr/lib/syslinux/pxelinux.0 /tftpboot/
```

### C.6.4 Start the DHCP, TFTP and HTTP

Start the DHCP, TFTP and HTTP. For example:

#### CentOS

```
#service xinetd restart
```

```
#service httpd restart
```

```
#service dhcpd restart
```

#### Debian

```
#/etc/init.d/xinetd reload
```

```
#/etc/init.d/xinetd restart
```

```
#/etc/init.d/dhcp3-server restart
```

### C.6.5 Create Shared Directory

**Step 1:** Install the samba.

```
#yum install samba
```

**Step 2:** Create a shared directory for the factory default image.

```
#mkdir /share
```

```
#cd /share
```

```
#mkdir /image
```

```
#cp iei.gho /image
```



#### **WARNING:**

The file name of the factory default image must be **iei.gho**.

---

**Step 3:** Confirm the operating system default settings: smb.conf.

```
#vi /etc/samba/smb.conf
```

Modify:

[image]

comment = One Key Recovery

path = /share/image

browseable = yes

writable = yes

public = yes

create mask = 0644

directory mask = 0755

**Step 4:** Edit “/etc/samba/smb.conf” for your environment. For example:

```
# "security = user" is always a good idea. This will require a Unix account
# in this server for every user accessing the server. See
# /usr/share/doc/samba-doc/htmldocs/Samba3-HOWTO/ServerType.html
# in the samba-doc package for details.
security = share
```

```
[image]
comment = One Key Recovery
path = /share/image
browseable = yes
writable = yes
public = yes
create mask = 0644
directory mask = 0755
```

**Step 5:** Modify the hostname

#vi /etc/hostname

Modify: RecoveryServer

```
RecoveryServer
```

### C.6.6 Setup a Client System for Auto Recovery

**Step 1:** Configure the following BIOS options of the client system.

Advanced → iEi Feature → Auto Recovery Function → **Enabled**

Advanced → iEi Feature → Recover from PXE → **Enabled**

Boot → Launch PXE OpROM → **Enabled**

## uIBX-210-CV-N2600 Embedded System

**Step 2:** Continue to configure the **Boot Option Priorities** BIOS option of the client system:

Boot Option #1 → remain the default setting to boot from the original OS.

Boot Option #2 → select the boot from LAN option.

**Step 3:** Save changes and exit BIOS menu.

Exit → **Save Changes and Exit**

**Step 4:** Install the auto recovery utility into the system by double clicking the **Utility/AUTORECOVERY-SETUP.exe** in the One Key Recovery CD. This utility **MUST** be installed in the system, otherwise, the system will automatically restore from the factory default image every ten (10) minutes.



**Step 5:** Restart the client system from LAN. If the system encounters a Blue Screen of Death (BSoD) or a hang for around 10 minutes, it will automatically restore from the factory default image. The following screens will show when the system starts auto recovering.

```
Realtek PCIe GBE Family Controller Series v2.35 (06/14/10)
CLIENT MAC ADDR: 00 18 7D 13 E6 89  GUID: 00020003-0004-0005-0006-0007000000
DHCP . ./
```



```
My IP address seems to be C0A80009 192.168.0.9
ip=192.168.0.9:192.168.0.8:192.168.0.2:255.255.255.0
TFTP prefix:
Trying to load: pxelinux.cfg/00020003-0004-0005-0006-000700080009
Trying to load: pxelinux.cfg/01-00-18-7d-13-e6-89
Trying to load: pxelinux.cfg/C0A80009
Trying to load: pxelinux.cfg/C0A8000
Trying to load: pxelinux.cfg/C0A800
Trying to load: pxelinux.cfg/C0A80
Trying to load: pxelinux.cfg/C0A8
Trying to load: pxelinux.cfg/C0A
Trying to load: pxelinux.cfg/C0
Trying to load: pxelinux.cfg/C
Trying to load: pxelinux.cfg/default
boot:
```

Windows is loading files...

IP: 192.168.0.8, File: \Boot\WinPE.wim

Symantec Ghost 11.5 Copyright (C) 1998-2008 Symantec Corporation. All rights reserved.

Progress Indicator



0% 25% 50% 75% 100%

Statistics

|                  |      |
|------------------|------|
| Percent complete | 52   |
| Speed (MB/min)   | 468  |
| MB copied        | 632  |
| MB remaining     | 563  |
| Time elapsed     | 1:21 |
| Time remaining   | 1:12 |

Details

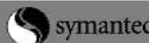
|                  |  |
|------------------|--|
| Connection type  | Local  |
| Source Partition | Type:7 [NTFS], 100006 MB, 1951 MB used, No name from Local drive [80], 130129 MB |
| Destination file | Local file D:\iei.GHO  |
| Current file     | 3891_e_869.nls   |



#### NOTE:

A firewall or a SELinux is not in use in the whole setup process. If there is a firewall or a SELinux protecting the system, modify the configuration information to accommodate them.

## C.7 Other Information

### C.7.1 Using AHCI Mode or ALi M5283 / VIA VT6421A Controller

When the system uses AHCI mode or some specific SATA controllers such as ALi M5283 or VIA VT6421A, the SATA RAID/AHCI driver must be installed before using one key recovery. Please follow the steps below to install the SATA RAID/AHCI driver.

**Step 1:** Copy the SATA RAID/AHCI driver to a floppy disk and insert the floppy disk into a USB floppy disk drive. The SATA RAID/AHCI driver must be especially designed for the on-board SATA controller.

**Step 2:** Connect the USB floppy disk drive to the system.

**Step 3:** Insert the One Key Recovery CD into the system and boot the system from the CD.

**Step 4:** When launching the recovery tool, press <F6>.

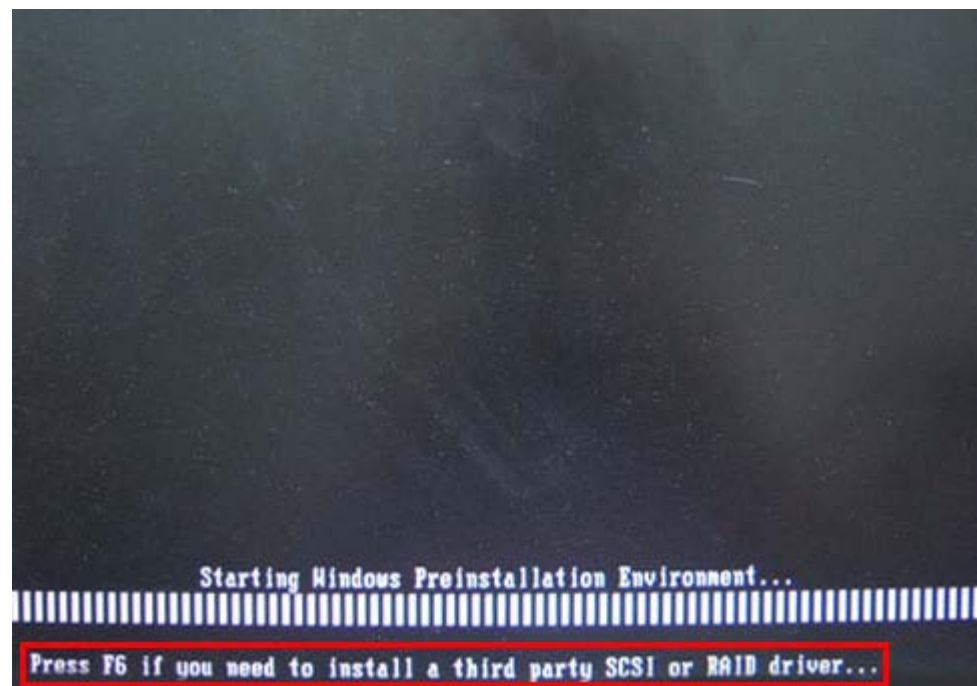

Step 5: When the following window appears, press <S> to select “Specify Additional Device”.

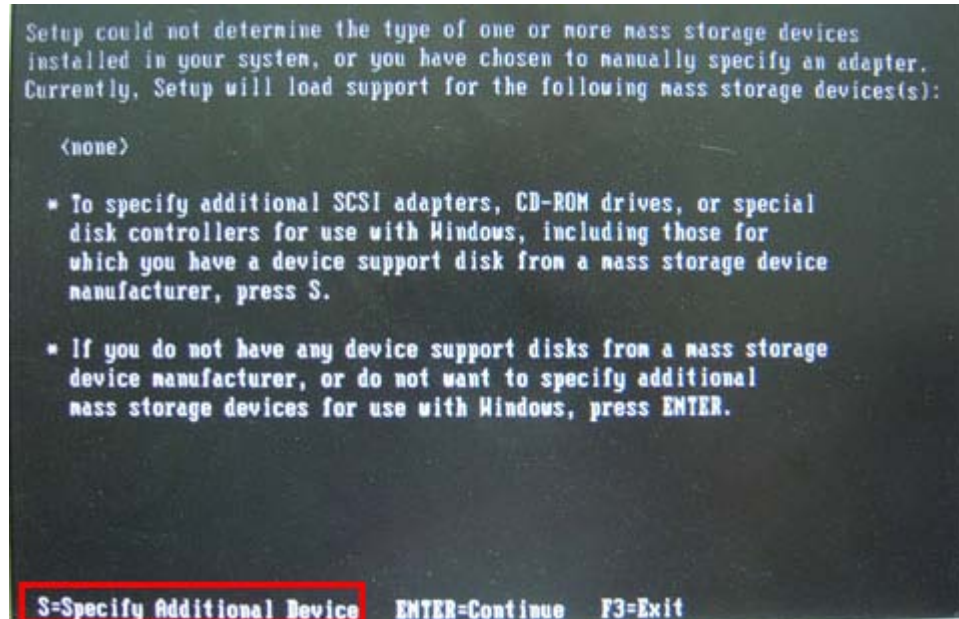

Step 6: In the following window, select a SATA controller mode used in the system. Then press <Enter>. The user can now start using the SATA HDD.

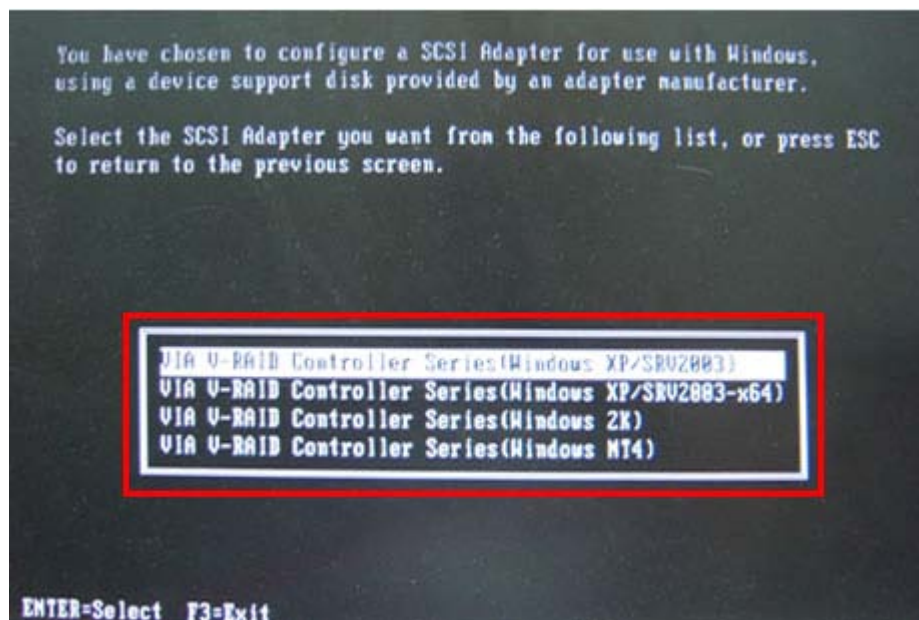

- Step 7:** After pressing <Enter>, the system will get into the recovery tool setup menu. Continue to follow the setup procedure from **Step 4** in **Section C.2.2 Create Partitions** to finish the whole setup process.

### C.7.2 System Memory Requirement

To be able to access the recovery tool by pressing <F3> while booting up the system, please make sure to have enough system memory. The minimum memory requirement is listed below.

- **Using Award BIOS:** 128 MB system memory
- **Using AMI BIOS:** 512 MB system memory.

Appendix

D

# Watchdog Timer

---

**NOTE:**

The following discussion applies to DOS environment. IEI support is contacted or the IEI website visited for specific drivers for more sophisticated operating systems, e.g., Windows and Linux.

The Watchdog Timer is provided to ensure that standalone systems can always recover from catastrophic conditions that cause the CPU to crash. This condition may have occurred by external EMI or a software bug. When the CPU stops working correctly, Watchdog Timer either performs a hardware reset (cold boot) or a Non-Maskable Interrupt (NMI) to bring the system back to a known state.

A BIOS function call (INT 15H) is used to control the Watchdog Timer:

**INT 15H:**

|                        |   |
|------------------------|---|
| AH – 6FH Sub-function: |   |
| AL – 2:                | Sets the Watchdog Timer's period.   |
| BL:                    | Time-out value (Its unit-second is dependent on the item "Watchdog Timer unit select" in CMOS setup). |

**Table D-1: AH-6FH Sub-function**

Call sub-function 2 to set the time-out period of Watchdog Timer first. If the time-out value is not zero, the Watchdog Timer starts counting down. While the timer value reaches zero, the system resets. To ensure that this reset condition does not occur, calling sub-function 2 must periodically refresh the Watchdog Timer. However, the Watchdog timer is disabled if the time-out value is set to zero.

A tolerance of at least 10% must be maintained to avoid unknown routines within the operating system (DOS), such as disk I/O that can be very time-consuming.

**NOTE:**

When exiting a program it is necessary to disable the Watchdog Timer, otherwise the system resets.

**Example program:**

```
; INITIAL TIMER PERIOD COUNTER
;
W_LOOP:

    MOV     AX, 6F02H      ;setting the time-out value
    MOV     BL, 05        ;time-out value is 5 seconds
    INT     15H

;
; ADD THE APPLICATION PROGRAM HERE
;

    CMP     EXIT_AP, 1    ;is the application over?
    JNE     W_LOOP       ;No, restart the application

    MOV     AX, 6F02H    ;disable Watchdog Timer
    MOV     BL, 0        ;
    INT     15H

;
; EXIT ;
```

Appendix

E

# Hazardous Materials Disclosure

---



## E.1 Hazardous Materials Disclosure Table for IPB Products Certified as RoHS Compliant Under 2002/95/EC Without Mercury

The details provided in this appendix are to ensure that the product is compliant with the Peoples Republic of China (China) RoHS standards. The table below acknowledges the presences of small quantities of certain materials in the product, and is applicable to China RoHS only.

A label will be placed on each product to indicate the estimated “Environmentally Friendly Use Period” (EFUP). This is an estimate of the number of years that these substances would “not leak out or undergo abrupt change.” This product may contain replaceable sub-assemblies/components which have a shorter EFUP such as batteries and lamps. These components will be separately marked.

Please refer to the table on the next page.

## uIBX-210-CV-N2600 Embedded System

| Part Name               | Toxic or Hazardous Substances and Elements |              |              |                              |                                |                                       |
|-------------------------|--|--------------|--------------|------------------------------|--------------------------------|---------------------------------------|
|                         | Lead (Pb)                                  | Mercury (Hg) | Cadmium (Cd) | Hexavalent Chromium (CR(VI)) | Polybrominated Biphenyls (PBB) | Polybrominated Diphenyl Ethers (PBDE) |
| Housing                 | X  | O            | O            | O                            | O                              | X                                     |
| Display                 | X  | O            | O            | O                            | O                              | X                                     |
| Printed Circuit Board   | X  | O            | O            | O                            | O                              | X                                     |
| Metal Fasteners         | X  | O            | O            | O                            | O                              | O                                     |
| Cable Assembly          | X  | O            | O            | O                            | O                              | X                                     |
| Fan Assembly            | X  | O            | O            | O                            | O                              | X                                     |
| Power Supply Assemblies | X  | O            | O            | O                            | O                              | X                                     |
| Battery                 | O  | O            | O            | O                            | O                              | O                                     |

O: This toxic or hazardous substance is contained in all of the homogeneous materials for the part is below the limit requirement in SJ/T11363-2006

X: This toxic or hazardous substance is contained in at least one of the homogeneous materials for this part is above the limit requirement in SJ/T11363-2006

此附件旨在确保本产品符合中国 RoHS 标准。以下表格标示此产品中某有毒物质的含量符合中国 RoHS 标准规定的限量要求。

本产品上会附有“环境友好使用期限”的标签，此期限是估算这些物质“不会有泄漏或突变”的年限。本产品可能包含有较短的环境友好使用期限的可替换元件，像是电池或灯管，这些元件将会单独标示出来。

| 部件名称   | 有毒有害物质或元素 |           |           |                 |               |                     |
|--------|-----------|-----------|-----------|-----------------|---------------|---------------------|
|        | 铅<br>(Pb) | 汞<br>(Hg) | 镉<br>(Cd) | 六价铬<br>(CR(VI)) | 多溴联苯<br>(PBB) | 多溴二苯<br>醚<br>(PBDE) |
| 壳体     | X         | O         | O         | O               | O             | X                   |
| 显示     | X         | O         | O         | O               | O             | X                   |
| 印刷电路板  | X         | O         | O         | O               | O             | X                   |
| 金属螺帽   | X         | O         | O         | O               | O             | O                   |
| 电缆组装   | X         | O         | O         | O               | O             | X                   |
| 风扇组装   | X         | O         | O         | O               | O             | X                   |
| 电力供应组装 | X         | O         | O         | O               | O             | X                   |
| 电池     | O         | O         | O         | O               | O             | O                   |

O: 表示该有毒有害物质在该部件所有物质材料中的含量均在 SJ/T11363-2006 标准规定的限量要求以下。  
 X: 表示该有毒有害物质至少在该部件的某一均质材料中的含量超出 SJ/T11363-2006 标准规定的限量要求。