

**MODEL:**  
**NANO-BT Series**

**EPIC SBC with 22nm Intel® Atom™ or Celeron® SoC,  
Dual GbE, DDR3, HDMI, VGA, LVDS, USB 2.0/3.0, COM Ports  
Two SATA 3Gb/s Ports, IPMI 2.0 and RoHS**

# User Manual

# Revision

Date	Version	Changes
July 10, 2018	1.14	Minor update
June 29, 2017	1.13	Clarified BIOS specifications
August 10, 2016	1.12	Modified power connector (CN10) orientation
October 28, 2015	1.11	Updated Figure 1-4: NANO-BT Main Dimensions (mm)
June 4, 2015	1.10	Updated for R11 version
October 1, 2014	1.03	Updated <b>Section 1.6: Dimensions</b>
June 27, 2014	1.02	Updated supported memory specifications in Chapter 1.
May 7, 2014	1.01	Updated <b>Section 1.6: Dimensions</b> Updated <b>Chapter 6: Software Drivers</b> Updated <b>Table 3-15: LVDS Connector Pinouts</b>
April 3, 2014	1.00	Initial release

# Copyright

---

## **COPYRIGHT NOTICE**

The information in this document is subject to change without prior notice in order to improve reliability, design and function and does not represent a commitment on the part of the manufacturer.

In no event will the manufacturer be liable for direct, indirect, special, incidental, or consequential damages arising out of the use or inability to use the product or documentation, even if advised of the possibility of such damages.

This document contains proprietary information protected by copyright. All rights are reserved. No part of this manual may be reproduced by any mechanical, electronic, or other means in any form without prior written permission of the manufacturer.

## **TRADEMARKS**

All registered trademarks and product names mentioned herein are used for identification purposes only and may be trademarks and/or registered trademarks of their respective owners.

# Manual Conventions

---



## **WARNING**

Warnings appear where overlooked details may cause damage to the equipment or result in personal injury. Warnings should be taken seriously.



## **CAUTION**

Cautionary messages should be heeded to help reduce the chance of losing data or damaging the product.



## **NOTE**

These messages inform the reader of essential but non-critical information. These messages should be read carefully as any directions or instructions contained therein can help avoid making mistakes.



## **HOT SURFACE**

This symbol indicates a hot surface that should not be touched without taking care.

# Table of Contents

<b>1 INTRODUCTION.....</b>	<b>1</b>
1.1 INTRODUCTION.....	2
1.2 MODEL VARIATIONS .....	3
1.3 BENEFITS .....	4
1.4 FEATURES.....	4
1.5 CONNECTORS .....	5
1.6 DIMENSIONS.....	7
1.7 DATA FLOW .....	9
1.8 TECHNICAL SPECIFICATIONS .....	10
<b>2 PACKING LIST.....</b>	<b>13</b>
2.1 ANTI-STATIC PRECAUTIONS .....	14
2.2 UNPACKING PRECAUTIONS.....	14
2.3 PACKING LIST.....	15
2.4 OPTIONAL ITEMS .....	16
<b>3 CONNECTORS .....</b>	<b>17</b>
3.1 PERIPHERAL INTERFACE CONNECTORS.....	18
3.1.1 NANO-BT Layout.....	18
3.1.2 Peripheral Interface Connectors .....	19
3.1.3 External Interface Panel Connectors.....	21
3.2 INTERNAL PERIPHERAL CONNECTORS .....	22
3.2.1 +12 V Power Connector .....	22
3.2.2 Audio Connector .....	23
3.2.3 Battery Connector.....	24
3.2.4 Backlight Inverter Connector .....	25
3.2.5 Buzzer Connector.....	26
3.2.6 Chassis Intrusion Connector.....	27
3.2.7 Digital I/O Connector.....	28
3.2.8 Fan Connector (CPU).....	29
3.2.9 Fan Connector (System) .....	30



3.2.10 Front Panel Connector .....	31
3.2.11 IPMI LED Connector .....	32
3.2.12 iRIS Module Slot (NANO-BT-i1 Models Only) .....	33
3.2.13 LAN LED Connectors .....	33
3.2.14 LVDS Connector .....	34
3.2.15 Memory Card Slot .....	36
3.2.16 microSD Card Slot (E38xx Models Only) .....	36
3.2.17 PCI-104 Connector .....	37
3.2.18 PCIe Mini Card Slot .....	38
3.2.19 Power Button Connector .....	40
3.2.20 Power Button .....	41
3.2.21 Reset Button Connector .....	41
3.2.22 SATA 3Gb/s Drive Connectors .....	42
3.2.23 SATA Power Connectors .....	43
3.2.24 Serial Port Connectors, RS-232 .....	45
3.2.25 Serial Port Connector, RS-422/485 .....	46
3.2.26 SMBus Connector .....	47
3.2.27 SPI Flash Connector .....	48
3.2.28 SPI Flash Connector, EC .....	49
3.2.29 USB 2.0 Connector .....	50
<b>3.3 EXTERNAL PERIPHERAL INTERFACE CONNECTOR PANEL .....</b>	<b>51</b>
3.3.1 Ethernet Connectors .....	51
3.3.2 HDMI Connector .....	52
3.3.3 Keyboard/Mouse Connector .....	53
3.3.4 USB 2.0 Connector .....	54
3.3.5 USB 3.0 Connector .....	55
3.3.6 VGA Connector .....	55
<b>4 INSTALLATION .....</b>	<b>57</b>
4.1 ANTI-STATIC PRECAUTIONS .....	58
4.2 INSTALLATION CONSIDERATIONS .....	58
4.2.1 SO-DIMM Installation .....	60
4.2.2 iRIS-1010 Module Installation (Optional) .....	60
4.2.3 PCIe Mini Card Installation .....	62
4.3 SYSTEM CONFIGURATION .....	62

## NANO-BT EPIC SBC

4.3.1 AT/ATX Power Mode Setting .....	62
4.3.2 Clear CMOS Button .....	63
4.3.3 LVDS Panel Resolution Selection .....	64
4.3.4 LCD Voltage Selection .....	65
4.3.5 mSATA/SATA Selection .....	66
4.3.6 PCI-104 Voltage Selection .....	67
4.3.7 USB Power Select .....	67
4.4 INTERNAL PERIPHERAL DEVICE CONNECTIONS .....	68
4.4.1 AT Power Connection .....	68
4.4.2 SATA Drive Connection .....	69
4.4.3 Single RS-232 Cable Connection .....	70
4.5 IPMI SETUP PROCEDURE (FOR NANO-BT-I1 MODELS ONLY) .....	71
4.5.1 Managed System Hardware Setup .....	72
<b>5 BIOS .....</b>	<b>73</b>
5.1 INTRODUCTION .....	74
5.1.1 Starting Setup .....	74
5.1.2 Using Setup .....	74
5.1.3 Getting Help .....	75
5.1.4 Unable to Reboot after Configuration Changes .....	75
5.1.5 BIOS Menu Bar .....	75
5.2 MAIN .....	76
5.3 ADVANCED .....	77
5.3.1 ACPI Settings .....	78
5.3.2 F81866 Super IO Configuration .....	79
5.3.2.1 Serial Port n Configuration .....	79
5.3.3 iWDD H/W Monitor .....	84
5.3.3.1 Smart Fan Mode Configuration .....	85
5.3.4 RTC Wake Settings .....	87
5.3.5 Serial Port Console Redirection .....	88
5.3.6 IEI Feature .....	91
5.3.7 CPU Configuration .....	92
5.3.8 IDE Configuration .....	94
5.3.9 USB Configuration .....	95
5.4 CHIPSET .....	96

5.4.1 North Bridge .....	97
5.4.1.1 Intel IGD Configuration.....	97
5.4.2 South Bridge.....	100
5.4.2.1 PCI Express Configuration .....	101
5.5 SECURITY.....	102
5.6 BOOT.....	103
5.7 EXIT .....	105
<b>6 SOFTWARE DRIVERS .....</b>	<b>107</b>
6.1 AVAILABLE DRIVERS .....	108
6.2 DRIVER DOWNLOAD .....	109
<b>A REGULATORY COMPLIANCE .....</b>	<b>111</b>
<b>B PRODUCT DISPOSAL .....</b>	<b>113</b>
<b>C BIOS OPTIONS .....</b>	<b>115</b>
<b>D TERMINOLOGY .....</b>	<b>118</b>
<b>E WATCHDOG TIMER.....</b>	<b>123</b>
<b>F DIGITAL I/O INTERFACE .....</b>	<b>126</b>
<b>G HAZARDOUS MATERIALS DISCLOSURE.....</b>	<b>129</b>



# List of Figures

Figure 1-1: NANO-BT.....	2
Figure 1-2: Connectors (Front Side).....	5
Figure 1-3: Connectors (Solder Side).....	6
Figure 1-4: NANO-BT Main Dimensions (mm).....	7
Figure 1-5: NANO-BT Height Dimensions 1 (mm).....	8
Figure 1-6: NANO-BT Height Dimensions 2 (mm).....	8
Figure 1-7: Data Flow Diagram.....	9
Figure 3-1: Connectors and Jumpers (Front Side).....	18
Figure 3-2: Connectors and Jumpers (Solder Side).....	19
Figure 3-3: CPU Power Connector Location.....	22
Figure 3-4: Audio Connector Location.....	23
Figure 3-5: Battery Connector Location.....	24
Figure 3-6: Backlight Inverter Connector Location.....	25
Figure 3-7: Buzzer Connector Location.....	26
Figure 3-8: Chassis Intrusion Connector Location.....	27
Figure 3-9: Digital I/O Connector Location.....	28
Figure 3-10: CPU Fan Connector Location.....	29
Figure 3-11: System Fan Connector Location.....	30
Figure 3-12: Front Panel Connector Location.....	31
Figure 3-13: IPMI LED Connector Location.....	32
Figure 3-14: iRIS Module Slot Location.....	33
Figure 3-15: LAN LED Connector Locations.....	34
Figure 3-16: LVDS Connector Location.....	35
Figure 3-17: Memory Card Slot Location.....	36
Figure 3-18: microSD Card Slot Location.....	36
Figure 3-19: PCI-104 Connector Location.....	37
Figure 3-20: PCIe Mini Card Slot Location.....	39
Figure 3-21: Power Button Location.....	40
Figure 3-22: Power Button Location.....	41
Figure 3-23: Reset Button Connector Location.....	42

Figure 3-24: SATA 3Gb/s Drive Connector Locations .....	43
Figure 3-25: SATA Power Connector Locations .....	44
Figure 3-26: RS-232 Serial Port Connector Locations.....	45
Figure 3-27: RS-422/485 Connector Location.....	46
Figure 3-28: SMBus Connector Location .....	47
Figure 3-29: SPI Flash Connector Location.....	48
Figure 3-30: SPI EC Flash Connector Location.....	49
Figure 3-31: USB 2.0 Connector Location .....	50
Figure 3-32: External Peripheral Interface Connector .....	51
Figure 3-33: Ethernet Connector.....	52
Figure 3-34: HDMI Connector .....	53
Figure 3-35: PS/2 Pinout and Configuration .....	54
Figure 3-36: VGA Connector .....	56
Figure 4-1: SO-DIMM Installation .....	60
Figure 4-2: iRIS-1010 Module Installation .....	61
Figure 4-3: PCIe Mini Card Installation.....	62
Figure 4-4: AT/ATX Power Mode Switch Location .....	63
Figure 4-5: Clear CMOS Button Location.....	63
Figure 4-6: LVDS Panel Resolution Selection Switch Location .....	65
Figure 4-7: LCD Voltage Selection Switch Location .....	66
Figure 4-8: mSATA/SATA Switch Location.....	66
Figure 4-9: PCI-104 Voltage Switch Location .....	67
Figure 4-10: Power Cable to Motherboard Connection .....	68
Figure 4-11: Connect Power Cable to Power Supply.....	69
Figure 4-12: SATA Drive Cable Connection.....	70
Figure 4-13: Single RS-232 Cable Installation .....	71
Figure 6-1: IEI Resource Download Center.....	108

# List of Tables

Table 1-1: Model Variations .....	3
Table 1-2: NANO-BT Specifications.....	12
Table 2-1: Packing List.....	15
Table 2-2: Optional Items .....	16
Table 3-1: Peripheral Interface Connectors .....	21
Table 3-2: Rear Panel Connectors .....	21
Table 3-3: CPU Power Connector Pinouts .....	22
Table 3-4: Audio Connector Pinouts .....	23
Table 3-5: Battery Connector Pinouts .....	25
Table 3-6: Backlight Inverter Connector Pinouts .....	25
Table 3-7: Chassis Intrusion Connector Pinouts .....	27
Table 3-8: Digital I/O Connector Pinouts.....	28
Table 3-9: CPU Fan Connector Pinouts.....	29
Table 3-10: System Fan Connector Pinouts .....	30
Table 3-11: Front Panel Connector Pinouts.....	31
Table 3-12: IPMI LED Connector Pinouts .....	32
Table 3-13: LAN1 LED Connector (JP8) Pinouts .....	34
Table 3-14: LAN2 LED Connector (JP9) Pinouts .....	34
Table 3-15: LVDS Connector Pinouts.....	35
Table 3-16: PCI-104 Connector Pinouts .....	38
Table 3-17: PCIe Mini Card Slot Pinouts .....	40
Table 3-18: Power Button Pinouts .....	40
Table 3-19: Reset Button Connector Pinouts .....	42
Table 3-20: SATA 3Gb/s Drive Connector Pinouts.....	43
Table 3-21: SATA Power Connector Pinouts.....	44
Table 3-22: RS-232 Serial Port Connector Pinouts .....	45
Table 3-23: RS-422/485 Connector Pinouts .....	46
Table 3-24: RS-422/485 Pinouts of D-sub 9 Connector.....	47
Table 3-25: SMBus Connector Pinouts .....	48
Table 3-26: SPI Flash Connector Pinouts .....	48

Table 3-27: SPI EC Flash Connector Pinouts .....	49
Table 3-28: USB 2.0 Connector Pinouts .....	50
Table 3-29: LAN1 Ethernet Connector Pinouts .....	51
Table 3-30: LAN2 Ethernet Connector Pinouts .....	52
Table 3-31: Connector LEDs.....	52
Table 3-32: HDMI Connector Pinouts .....	53
Table 3-33: Keyboard Connector Pinouts .....	54
Table 3-34: USB 2.0 Port Pinouts.....	54
Table 3-35: USB 3.0 Port Pinouts.....	55
Table 3-36: VGA Connector Pinouts.....	56
Table 4-1: LVDS Panel Resolution Selection.....	64
Table 4-2: LCD Voltage Selection Switch Settings .....	65
Table 4-3: mSATA/SATA Switch Settings .....	66
Table 4-4: PCI-104 Voltage Switch Settings.....	67
Table 5-1: BIOS Navigation Keys .....	75

# BIOS Menus

---

BIOS Menu 1: Main .....	76
BIOS Menu 2: Advanced .....	77
BIOS Menu 3: ACPI Configuration .....	78
BIOS Menu 4: F81866 Super IO Configuration .....	79
BIOS Menu 5: Serial Port n Configuration Menu .....	79
BIOS Menu 6: iWDD H/W Monitor .....	84
BIOS Menu 7: Smart Fan Mode Configuration .....	85
BIOS Menu 8: RTC Wake Settings .....	87
BIOS Menu 9: Serial Port Console Redirection .....	88
BIOS Menu 10: IEI Feature .....	91
BIOS Menu 11: CPU Configuration .....	92
BIOS Menu 12: IDE Configuration .....	94
BIOS Menu 13: USB Configuration .....	95
BIOS Menu 14: Chipset .....	96
BIOS Menu 15: North Bridge .....	97
BIOS Menu 16: Intel IGD Configuration .....	97
BIOS Menu 17: South Bridge .....	100
BIOS Menu 18: PCI Express Configuration .....	101
BIOS Menu 19: Security .....	102
BIOS Menu 20: Boot .....	103
BIOS Menu 21: Save & Exit .....	105





Chapter

1

# Introduction

---

## 1.1 Introduction

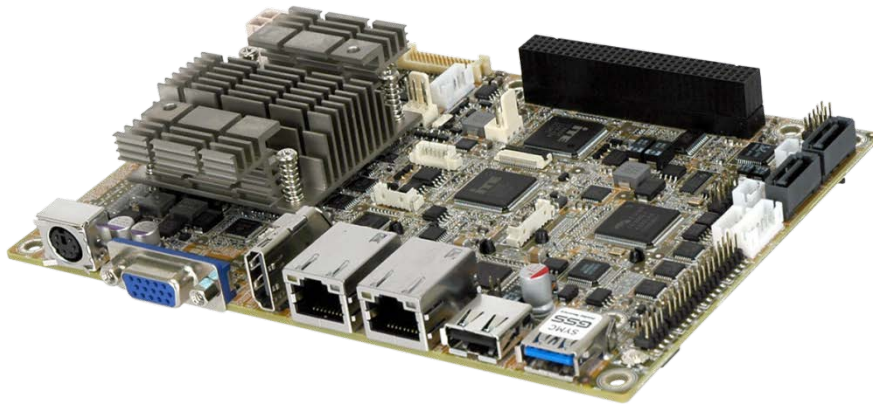

**Figure 1-1: NANO-BT**

The NANO-BT series is an EPIC form factor single board computer. It has an on-board 22nm Intel® Atom® or Celeron® processor, and supports one 204-pin 1333/1066 MHz dual-channel unbuffered DDR3 Low Voltage (DDR3L) SDRAM SO-DIMM with up to 8.0 GB of memory.

The NANO-BT-i1 models feature Intelligent Platform Management Interface (IPMI) that helps lower the overall costs of server management by enabling users to maximize IT resource, save time and manage multiple systems. The NANO-BT-i1 supports IPMI 2.0 through the optional iRIS-1010 module.

The NANO-BT includes one VGA port and one HDMI port for dual independent display. It also has an internal 18-bit/24-bit dual-channel LVDS connector supporting up to 1920 x 1200 resolutions. Expansion and I/O include one PCI-104 slot, one PCIe Mini slot, one USB 3.0 port plus one USB 2.0 on the rear panel, two USB 2.0 by pin header, two SATA 3Gb/s connectors, three RS-232 serial ports, and one PS/2 keyboard/mouse connector.

## NANO-BT EPIC SBC

### 1.2 Model Variations

There are several models of the NANO-BT series. The model variations are listed in **Table 1-1**.

Model	On-board SoC	Max. Memory	Operating Temp.	iRIS
<b>Standard</b>				
NANO-BT-i1-J19001	Intel® Celeron® processor J1900 (2 GHz, quad-core, 2 MB cache)	8 GB	-20°C - 60°C	Yes
NANO-BT-i1-N28071	Intel® Celeron® processor N2807 (1.58 GHz, dual-core, 2 MB cache)	4 GB	-20°C - 60°C	Yes
NANO-BT-i1-N29301	Intel® Celeron® processor N2930 (1.83 GHz, quad-core, 2 MB cache)	8 GB	-20°C - 60°C	Yes
NANO-BT-E38451W2	Intel® Atom® processor E3845 (1.91 GHz, quad-core, 2 MB cache)	8 GB	-40°C - 85°C	No
<b>By Request (MOQ: 100 pcs/lot)</b>				
NANO-BT-i1-E38151	Intel® Atom® processor E3815 (1.46 GHz, single-core, 512 KB cache)	4 GB	-20°C - 60°C	Yes
NANO-BT-E38151W2			-40°C - 85°C	No
NANO-BT-i1-E38251	Intel® Atom® processor E3825 (1.33 GHz, dual-core, 1 MB cache)	4 GB	-20°C - 60°C	Yes
NANO-BT-E38251W2			-40°C - 85°C	No
NANO-BT-i1-E38261	Intel® Atom® processor E3826 (1.46 GHz, dual-core, 1 MB cache)	8 GB	-20°C - 60°C	Yes
NANO-BT-E38261W2			-40°C - 85°C	No
NANO-BT-i1-E38271	Intel® Atom® processor E3827 (1.75 GHz, dual-core, 1 MB cache)	8 GB	-20°C - 60°C	Yes
NANO-BT-E38271W2			-40°C - 85°C	No
NANO-BT-i1-E38451	Intel® Atom® processor E3845 (1.91 GHz, quad-core, 2 MB cache)	8 GB	-20°C - 60°C	Yes

**Table 1-1: Model Variations**

## 1.3 Benefits

Some of the NANO-BT motherboard benefits include:

- Powerful graphics with multiple monitors
- Staying connected with both wired LAN connections
- Speedy running of multiple programs and applications

## 1.4 Features

Some of the NANO-BT motherboard features are listed below:

- EPIC form factor
- RoHS compliant
- On-board 22nm Intel® Atom® or Celeron® processor
- One 204-pin 1333/1066 MHz dual-channel unbuffered DDR3L (1.35 V) SDRAM SO-DIMM slot supports up to 8.0 GB of memory
- LVDS, VGA and HDMI interfaces for dual independent display
- Supports IPMI 2.0 via IEI iRIS-1010 module
- Two Intel® PCIe GbE connectors
- Two SATA 3Gb/s connectors
- One full-size PCIe Mini card expansion slot
- One PCI-104 expansion slot
- One USB 3.0 port and three USB 2.0 ports
- Three RS-232 serial ports and one RS-422/485 serial port
- High Definition Audio



## NANO-BT EPIC SBC

### 1.5 Connectors

The connectors on the NANO-BT are shown in the figure below.

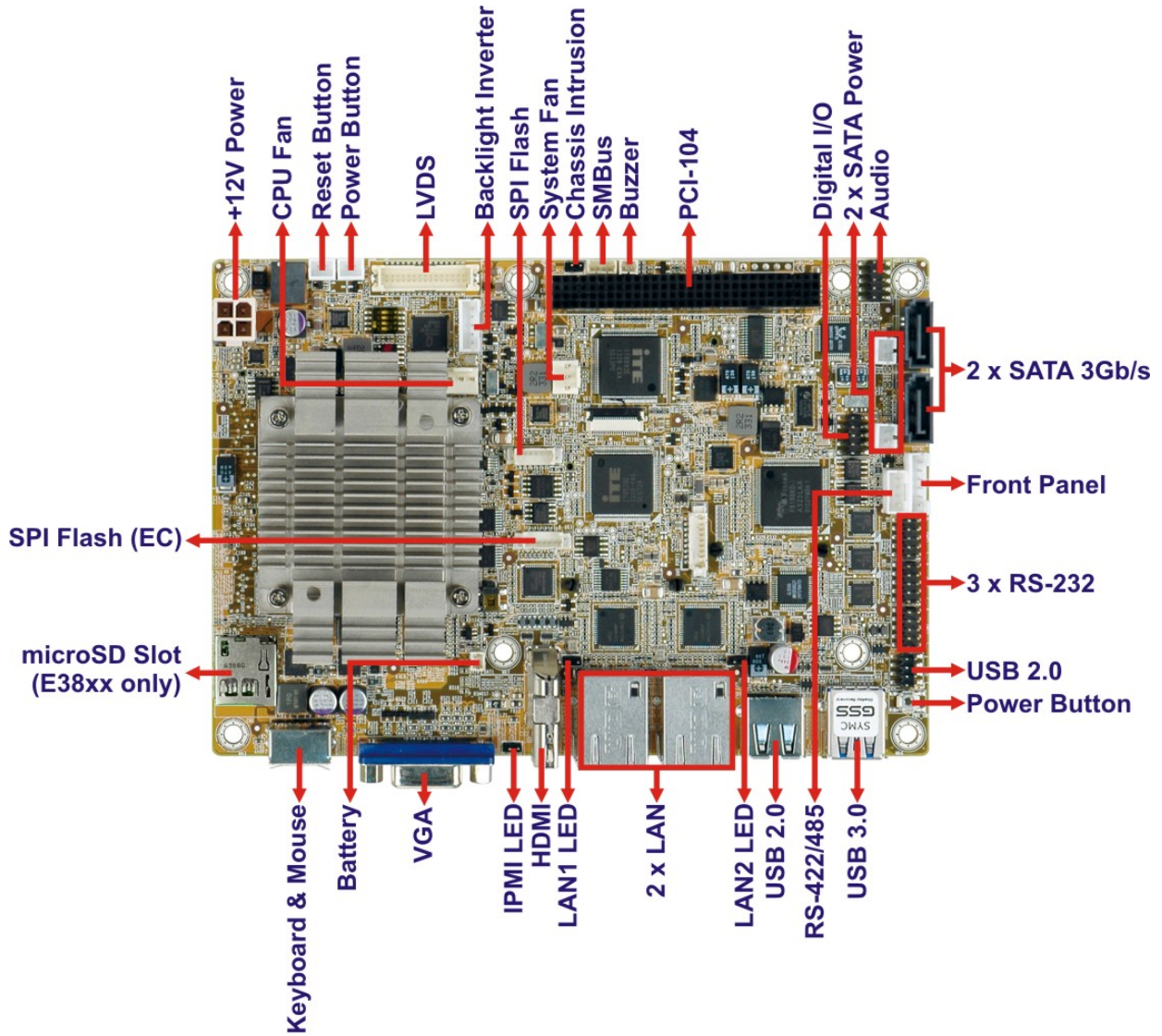
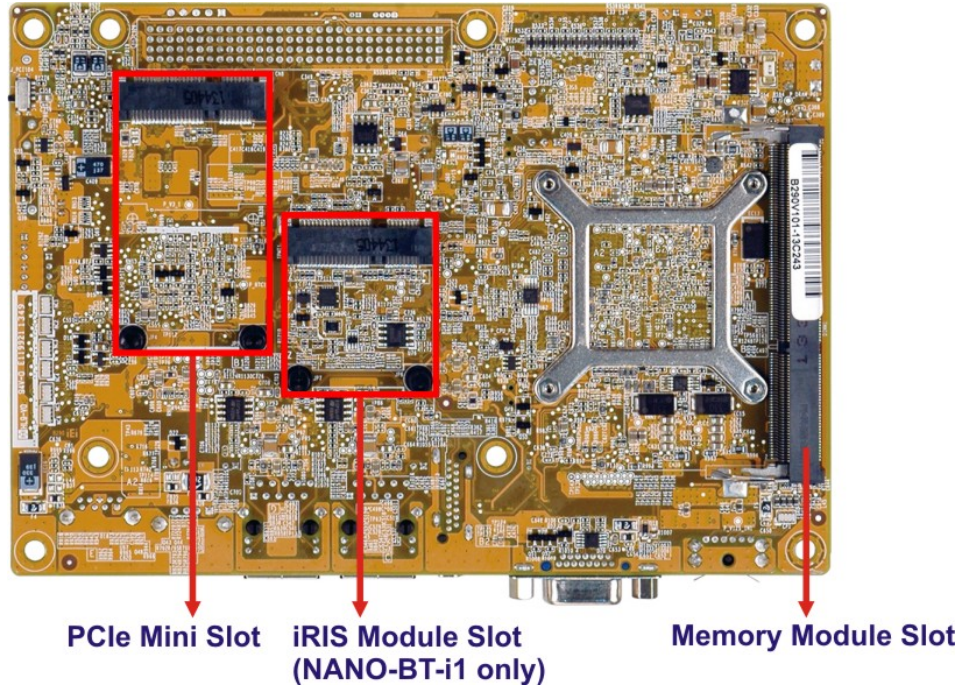

Figure 1-2: Connectors (Front Side)

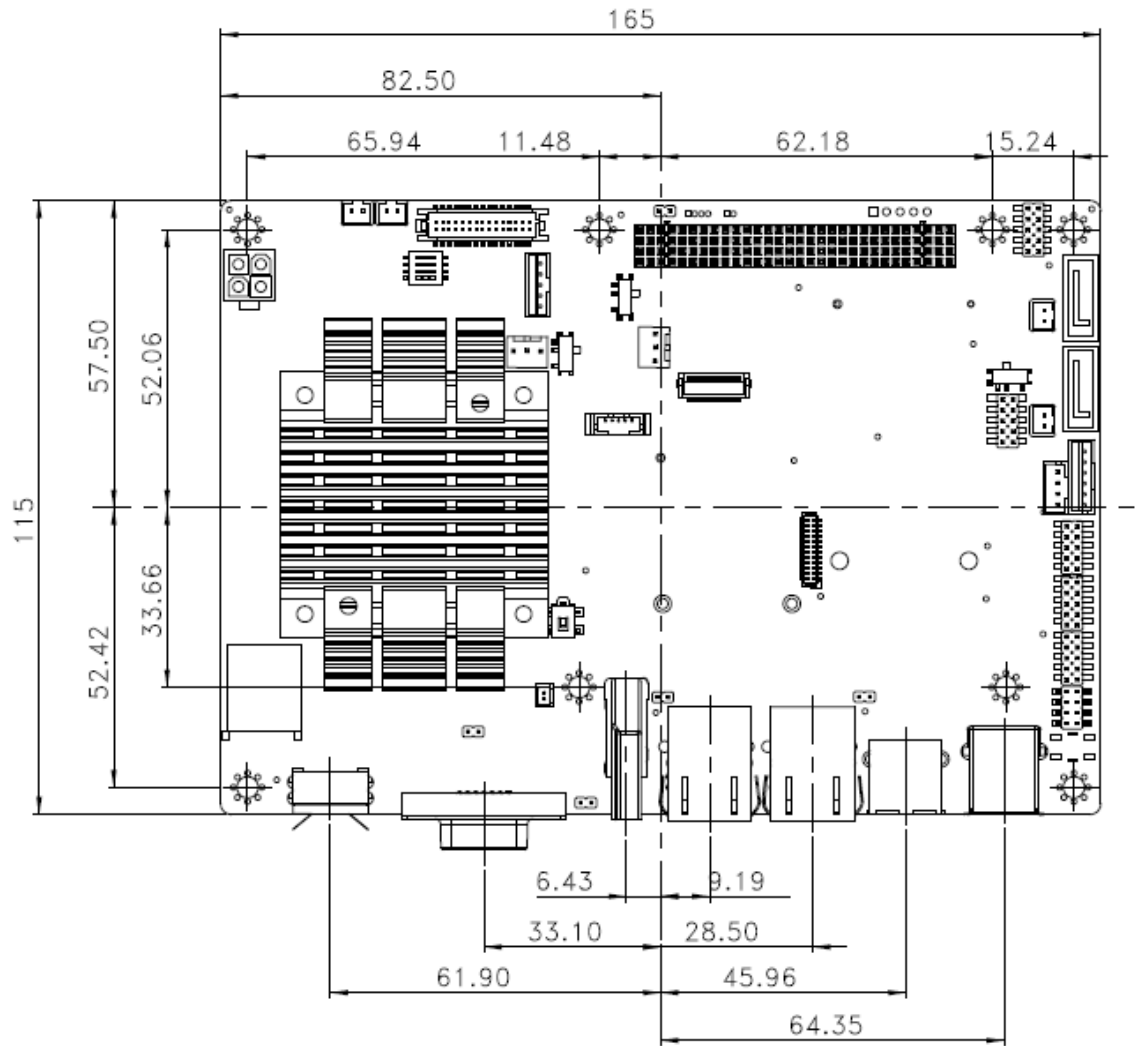

**Figure 1-3: Connectors (Solder Side)**

**NANO-BT EPIC SBC**

**1.6 Dimensions**

The main dimensions of the NANO-BT are shown in the diagram below.

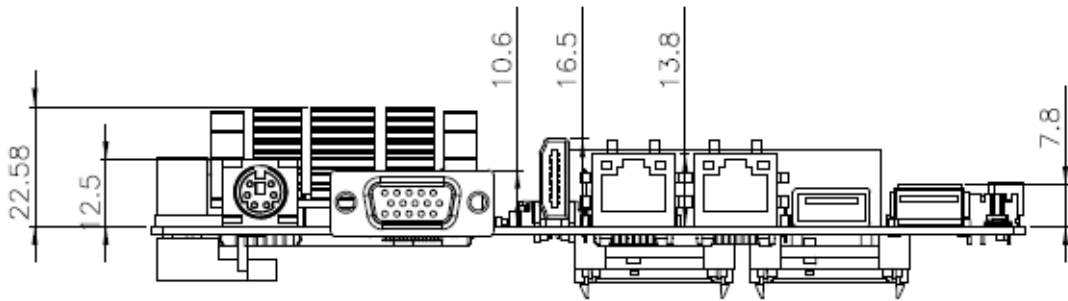

**Figure 1-4: NANO-BT Main Dimensions (mm)**



The height of the NANO-BT series varies depending on the heatsink installed on the board. **Figure 1-5** shows the height dimensions of the following models:

- NANO-BT-i1-E38271
- NANO-BT-i1-E38261
- NANO-BT-i1-E38251
- NANO-BT-i1-E38151
- NANO-BT-i1-N28071



**Figure 1-5: NANO-BT Height Dimensions 1 (mm)**

**Figure 1-6** shows the height dimensions of the following models:

- NANO-BT-i1-E38451
- NANO-BT-i1-J19001
- NANO-BT-i1-N29301
- NANO-BT-E38xx1W2

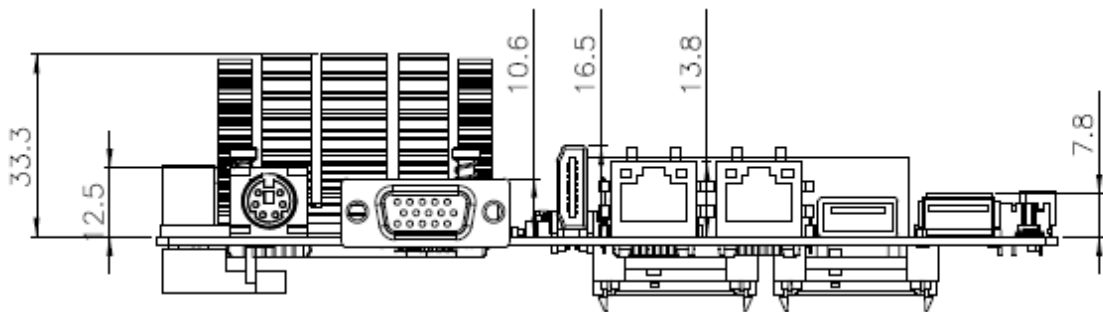

**Figure 1-6: NANO-BT Height Dimensions 2 (mm)**

NANO-BT EPIC SBC

1.7 Data Flow

Figure 1-7 shows the data flow between the system chipset, the CPU and other components installed on the motherboard.

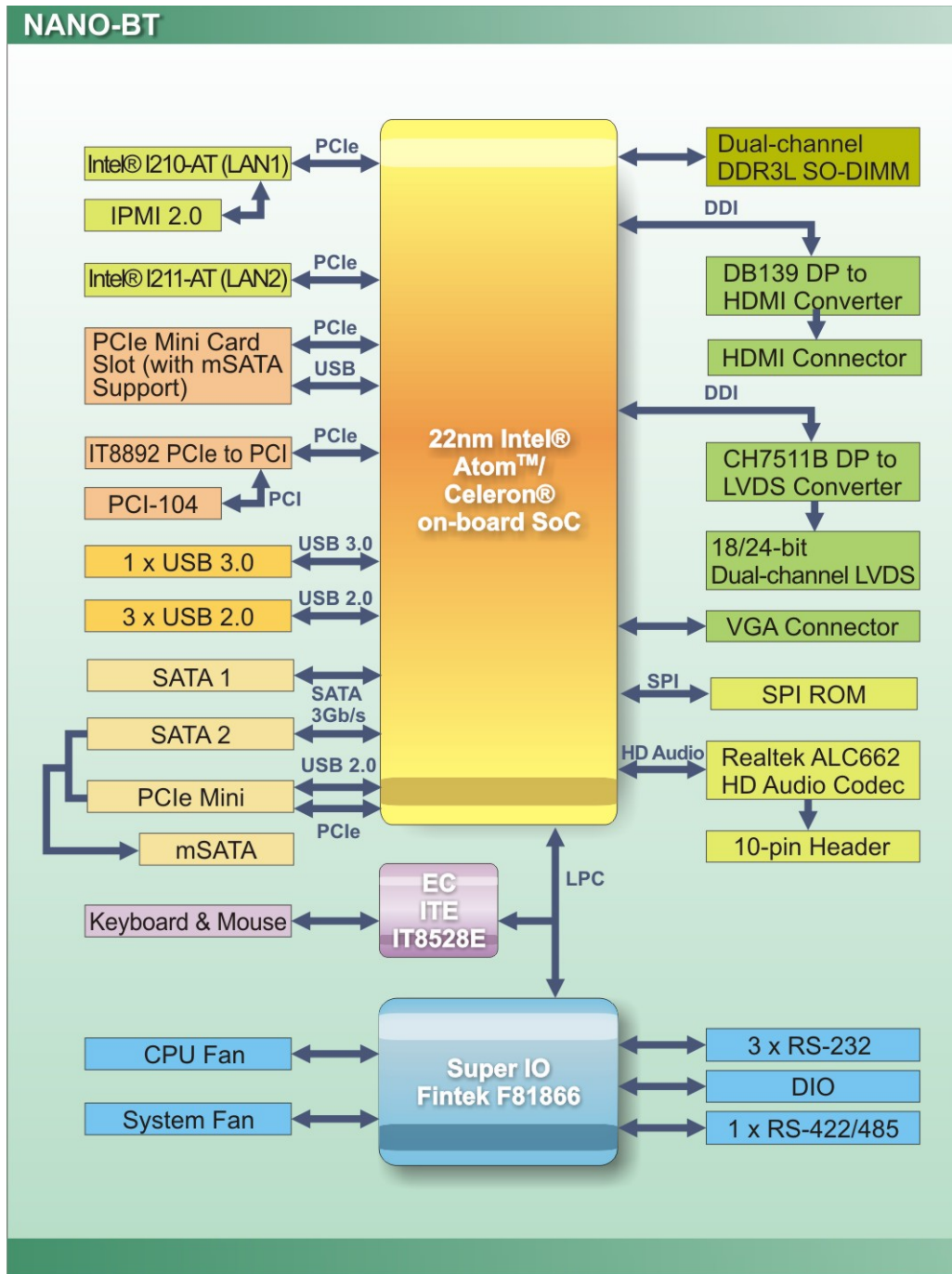

Figure 1-7: Data Flow Diagram



## 1.8 Technical Specifications

NANO-BT technical specifications are listed below.

Specification/Model	NANO-BT
<b>Form Factor</b>	EPIC
<b>On-board SoC</b>	Intel® Atom® processor E3845 (1.91GHz, quad-core, 2MB cache, TDP=10W) Intel® Atom® processor E3827 (1.75GHz, dual-core, 1MB cache, TDP=8W) Intel® Atom® processor E3826 (1.46GHz, dual-core, 1MB cache, TDP=7W) Intel® Atom® processor E3825 (1.33GHz, dual-core, 1MB cache, TDP=6W) Intel® Atom® processor E3815 (1.46GHz, single-core, 512KB cache, TDP=5W) Intel® Celeron® processor J1900 (2GHz, quad-core, 2MB cache, TDP=10W) Intel® Celeron® processor N2930 (1.83GHz, quad-core, 2MB cache, TDP=7.5W) Intel® Celeron® processor N2807 (1.58GHz, dual-core, 2MB cache, TDP=4.5W)
<b>Integrated Graphics</b>	Intel® HD Graphics Gen7 with 4 execution units, supporting DirectX 11.1, OpenCL 1.2 and OpenGL 4.2
<b>Memory</b>	One 204-pin 1066/1333MHz single-channel unbuffered DDR3L (1.35 V) SDRAM SO-DIMM supports up to 8 GB (J1900, N2930, E3845, E3827, E3826) or 4 GB (N2807, E3825, E3815)
<b>Audio</b>	Realtek ALC662 HD Audio codec
<b>BIOS</b>	UEFI BIOS <ul style="list-style-type: none"> <li>▪ Alxx BIOS version is for Bay Trail I model (CPU: E38xx)</li> <li>▪ AMxx BIOS version is for Bay Trail M/D model (CPU: J1900/ N2930/N2807)</li> </ul>
<b>Ethernet Controllers</b>	<b>LAN1:</b> Intel® I210-AT PCIe Ethernet controller with NCSI and IPMI 2.0 support <b>LAN2:</b> Intel® I211-AT PCIe Ethernet controller
<b>Digital I/O</b>	8-bit digital I/O (4-bit input, 4-bit output)
<b>IPMI 2.0</b>	Supported by the optional iRIS-1010 module (NANO-BT-i1 models only)
<b>Super I/O Controller</b>	Fintek F81866

## NANO-BT EPIC SBC

<b>Specification/Model</b>	<b>NANO-BT</b>
<b>Embedded Controller</b>	ITE IT8528E
<b>Watchdog Timer</b>	Software programmable supports 1 sec - 255 sec system reset
<b>Expansion</b>	
<b>PCI</b>	One PCI-104 slot (PCI signal)
<b>PCIe</b>	One full-size PCIe Mini card slot supports mSATA (co-lay SATA port 2)
<b>microSD</b>	One microSD card slot (E38xx models only)
<b>I/O Interface Connectors</b>	
<b>Audio Connector</b>	One internal audio connector (10-pin)
<b>Display Ports</b>	One VGA port (up to 2560 x 1600, 60Hz) One HDMI port (up to 1920 x 1080, 60Hz) 18-bit/24-bit dual-channel LVDS (up to 1920 x 1200, 60Hz)
<b>Ethernet</b>	Two RJ-45 GbE ports
<b>Keyboard/Mouse</b>	One PS/2 keyboard/mouse connector
<b>Serial Ports</b>	One RS-422/485 via internal wafer connector Three RS-232 via internal pin headers
<b>USB ports</b>	One external USB 3.0 port on rear IO One external USB 2.0 port on rear IO Two internal USB 2.0 ports by pin header
<b>Serial ATA</b>	Two SATA 3Gb/s connectors (without RAID support) Two 5 V SATA power connectors
<b>LAN LED</b>	Two 2-pin LAN active LED connectors
<b>SMBus</b>	Supported by one 4-pin wafer connector
<b>Environmental and Power Specifications</b>	

<b>Specification/Model</b>	<b>NANO-BT</b>
<b>Power Supply</b>	12 V only DC input through the internal 4-pin (2x2) power connector AT/ATX power supported
<b>Power Consumption</b>	12 V @ 1.52 A (1.91 GHz Intel® Celeron® processor J1900 with one 8 GB 1333 MHz DDR3 memory)
<b>Operating Temperature</b>	NANO-BT-i1: -20°C – 60°C NANO-BT-E38xx1W2: -40°C – 85°C
<b>Storage Temperature</b>	NANO-BT-i1: -30°C – 70°C NANO-BT-E38xx1W2: -40°C – 85°C
<b>Humidity</b>	5% – 95% (non-condensing)
<b>Physical Specifications</b>	
<b>Dimensions</b>	115 mm x 165 mm
<b>Weight GW/NW</b>	850 g / 350 g

**Table 1-2: NANO-BT Specifications**

Chapter

2

# Packing List

---

## 2.1 Anti-static Precautions

---



### WARNING!

Static electricity can destroy certain electronics. Make sure to follow the ESD precautions to prevent damage to the product, and injury to the user.

---

Make sure to adhere to the following guidelines:

- **Wear an anti-static wristband:** Wearing an anti-static wristband can prevent electrostatic discharge.
- **Self-grounding:** Touch a grounded conductor every few minutes to discharge any excess static buildup.
- **Use an anti-static pad:** When configuring any circuit board, place it on an anti-static mat.
- **Only handle the edges of the PCB:** Don't touch the surface of the motherboard. Hold the motherboard by the edges when handling.

## 2.2 Unpacking Precautions

When the NANO-BT is unpacked, please do the following:

- Follow the antistatic guidelines above.
- Make sure the packing box is facing upwards when opening.
- Make sure all the packing list items are present.



**NANO-BT EPIC SBC**





**2.3 Packing List**

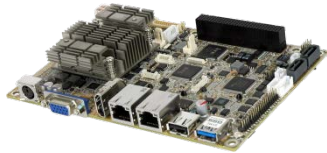

**NOTE:**

If any of the components listed in the checklist below are missing, do not proceed with the installation. Contact the IEI reseller or vendor the NANO-BT was purchased from or contact an IEI sales representative directly by sending an email to [sales@ieiworld.com](mailto:sales@ieiworld.com)





The NANO-BT is shipped with the following components:

Quantity	Item and Part Number	Image
1	NANO-BT single board computer	
2	SATA and power cable	
2	Single RS-232 cable	
1	12 V AT power cable	
1	Quick Installation Guide	

**Table 2-1: Packing List**

## 2.4 Optional Items

The following are optional components which may be separately purchased:

Item and Part Number	Image
IPMI 2.0 adapter card with AST1010 BMC chip (without KVM over IP function) for PCIe Mini socket interface (P/N: iRIS-1010-R10)	
Dual USB cable, 210mm (P/N: 32001-008600-200-RS)	
RS-422/485 cable, 200mm (P/N: 32205-003800-300-RS)	
Keyboard and mouse Y cable (P/N: 32006-000300-100-RS)	

**Table 2-2: Optional Items**

Chapter

**3**

# Connectors

---

### 3.1 Peripheral Interface Connectors

This chapter details all the jumpers and connectors.

#### 3.1.1 NANO-BT Layout

The figures below show all the connectors and jumpers.

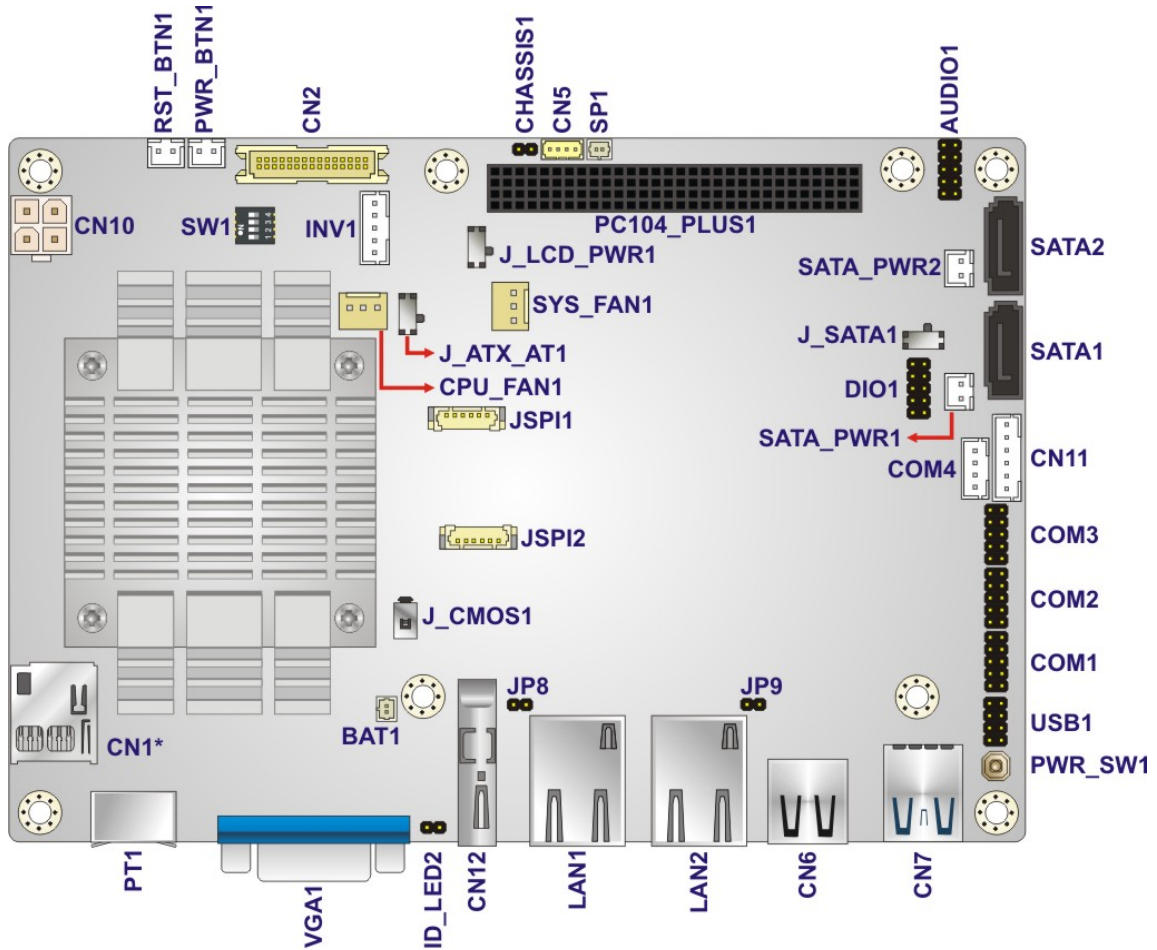

\*CN1 is only available in E38xx models.

**Figure 3-1: Connectors and Jumpers (Front Side)**

NANO-BT EPIC SBC

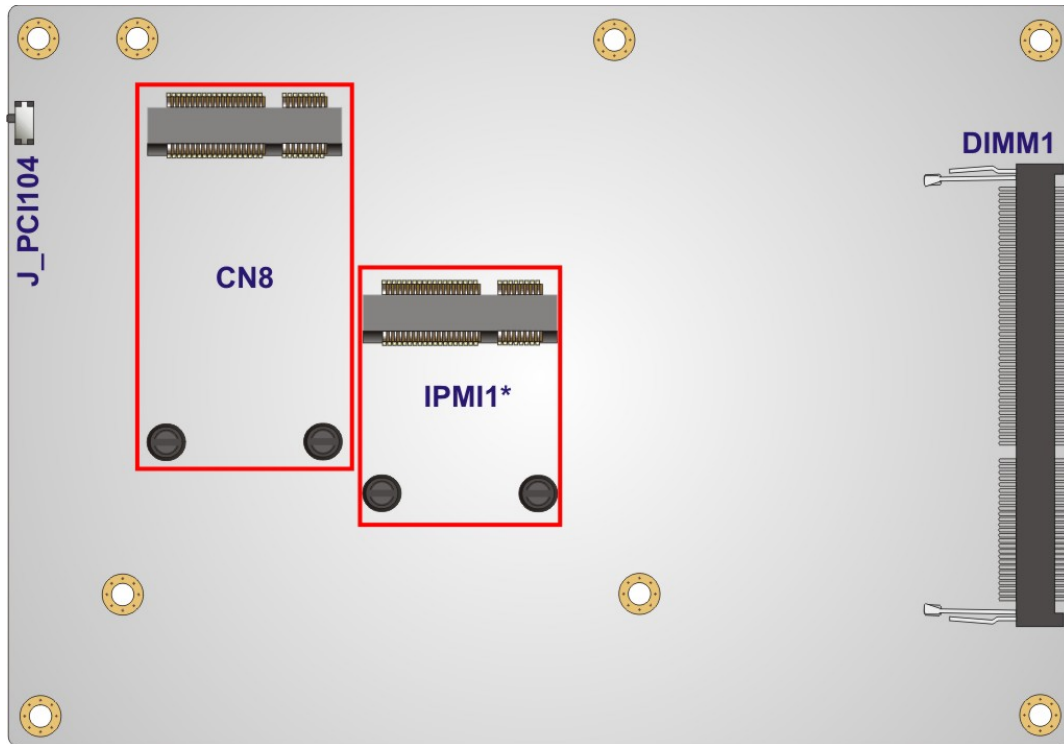

\*IPMI1 is only available in NANO-BT-i1 models.

Figure 3-2: Connectors and Jumpers (Solder Side)

### 3.1.2 Peripheral Interface Connectors

The table below lists all the connectors on the board.

Connector	Type	Label
12 V DC input connector	4-pin connector	CN10
Audio connector	10-pin header	AUDIO1
Battery connector	2-pin wafer	BAT1
Backlight inverter connector	5-pin wafer	INV1
Buzzer connector	2-pin wafer	SP1
Chassis intrusion connector	2-pin header	CHASSIS1



<b>Connector</b>	<b>Type</b>	<b>Label</b>
Digital I/O connector	10-pin header	DIO1
Fan connector (CPU)	3-pin wafer	CPU_FAN1
Fan connector (system)	3-pin wafer	SYS_FAN1
Front panel connector	6-pin wafer	CN11
iRIS module connector	Half-size PCIe Mini slot	IPMI1
IPMI LED connector	2-pin header	ID_LED2
LAN1 LED connector	2-pin header	JP8
LAN2 LED connector	2-pin header	JP9
LVDS connector	30-pin crimp	CN2
Memory card slot	DIMM slot	DIMM1
microSD card slot	microSD slot	CN1
PCI-104 slot	PCI-104 slot	PC104_PLUS1
PCIe Mini slot	Full-size PCIe Mini	CN8
Power button connector	2-pin wafer	PWR_BTN1
Power button	Push button	PWR_SW1
Reset button connector	2-pin wafer	RST_BTN1
SATA 3Gb/s drive connectors	7-pin SATA connector	SATA1, SATA2
SATA power connectors (5 V)	2-pin wafer	SATA_PWR1, SATA_PWR2
Serial ports, RS-232	10-pin header	COM1, COM2, COM3
Serial port, RS-422/485	4-pin wafer	COM4
SMBus connector	4-pin wafer	CN5
SPI flash connector	6-pin header	JSPI1
SPI flash connector (EC)	6-pin header	JSPI2

## NANO-BT EPIC SBC

Connector	Type	Label
USB 2.0 connector	8-pin header	USB1

**Table 3-1: Peripheral Interface Connectors**

### 3.1.3 External Interface Panel Connectors

The table below lists the connectors on the external I/O panel.

Connector	Type	Label
Ethernet ports	RJ-45	LAN1, LAN2
HDMI connector	HDMI	CN12
Keyboard/Mouse connector	PS/2	PT1
USB 2.0 connector	USB 2.0	CN6
USB 3.0 connector	USB 3.0	CN7
VGA connector	15-pin female	VGA1

**Table 3-2: Rear Panel Connectors**

## 3.2 Internal Peripheral Connectors

The section describes all of the connectors on the NANO-BT.

### 3.2.1 +12 V Power Connector

- CN Label:** CN10
- CN Type:** 4-pin Molex power connector, p=4.2 mm
- CN Location:** See **Figure 3-3**
- CN Pinouts:** See **Table 3-3**

The +12 V power input connector provides power to the system.

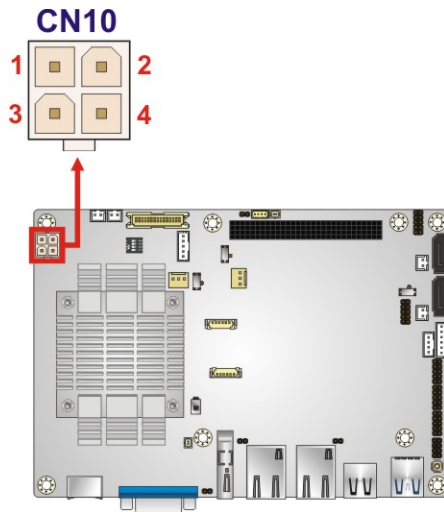

**Figure 3-3: CPU Power Connector Location**

PIN NO.	DESCRIPTION
1	GND
2	GND
3	+12 V
4	+12 V

**Table 3-3: CPU Power Connector Pinouts**

## NANO-BT EPIC SBC

### 3.2.2 Audio Connector

- CN Label:** AUDIO1
- CN Type:** 10-pin header, p=2.0 mm
- CN Location:** See **Figure 3-4**
- CN Pinouts:** See **Table 3-4**

This connector connects to speakers, a microphone and an audio input.

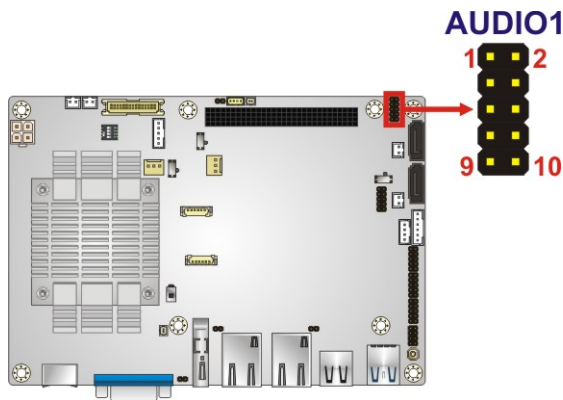

**Figure 3-4: Audio Connector Location**

Pin	Description	Pin	Description
1	LINE_OUTR	2	LINEIN_R
3	ANALOG_GND	4	ANALOG_GND
5	LINE_OUTL	6	LINEIN_L
7	ANALOG_GND	8	ANALOG_GND
9	MICIN1	10	MICIN2

**Table 3-4: Audio Connector Pinouts**

### 3.2.3 Battery Connector



**CAUTION:**

Risk of explosion if battery is replaced by an incorrect type. Only certified engineers should replace the on-board battery.

Dispose of used batteries according to instructions and local regulations.



**NOTE:**

It is recommended to attach the RTC battery onto the system chassis in which the NANO-BT is installed.

- CN Label:**            **BAT1**
- CN Type:**            2-pin wafer, p=1.25 mm
- CN Location:**      See **Figure 3-5**
- CN Pinouts:**        See **Table 3-5**

A system battery is placed in the battery holder. The battery provides power to the system clock to retain the time when power is turned off.

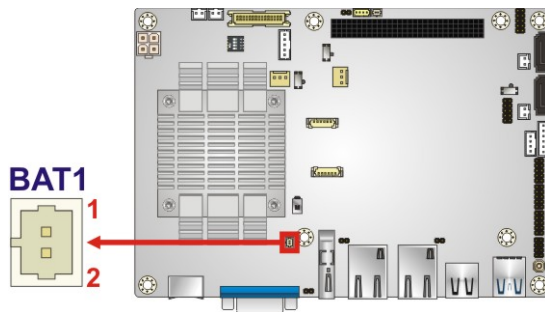

**Figure 3-5: Battery Connector Location**



## NANO-BT EPIC SBC

Pin	Description
1	VBATT
2	GND

Table 3-5: Battery Connector Pinouts

### 3.2.4 Backlight Inverter Connector

- CN Label:** INV1
- CN Type:** 5-pin wafer, p=2.0 mm
- CN Location:** See Figure 3-6
- CN Pinouts:** See Table 3-6

The backlight inverter connector provides power to an LCD panel.

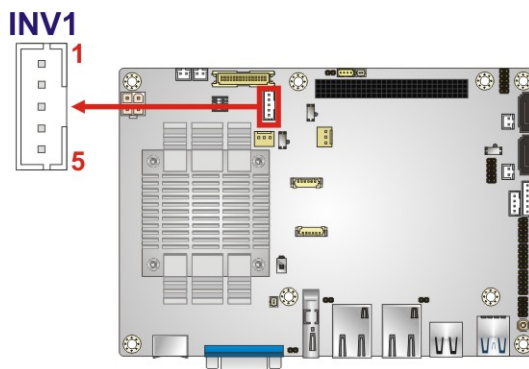

Figure 3-6: Backlight Inverter Connector Location

Pin	Description
1	BRIGHTNESS2
2	GND
3	VCC
4	GND
5	ENABKL2

Table 3-6: Backlight Inverter Connector Pinouts

### 3.2.5 Buzzer Connector

- CN Label:** SP1
- CN Type:** 2-pin wafer, p=1.25 mm
- CN Location:** See **Figure 3-7**

The connector is connected to a buzzer.

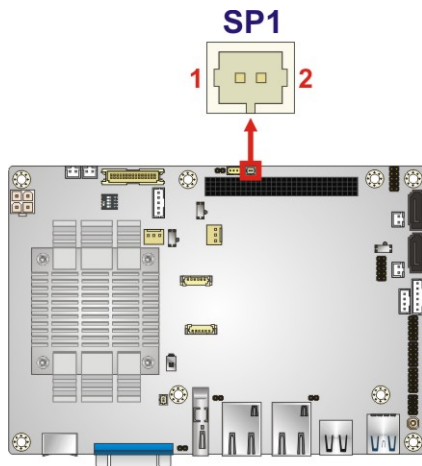

**Figure 3-7: Buzzer Connector Location**



**NOTE:**

If you cannot find a good place to put a buzzer on the NANO-BT, it is recommended to attach the buzzer onto the system chassis in which the NANO-BT is installed.

## NANO-BT EPIC SBC

### 3.2.6 Chassis Intrusion Connector

- CN Label:** CHASSIS1
- CN Type:** 2-pin header, , p=2.0 mm
- CN Location:** See **Figure 3-8**
- CN Pinouts:** See **Table 3-7**

The chassis intrusion connector is for a chassis intrusion detection sensor or switch that detects if a chassis component is removed or replaced.

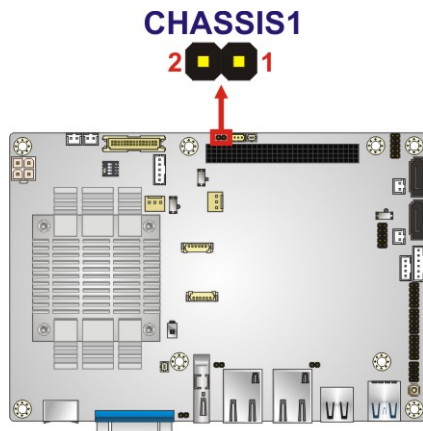

**Figure 3-8: Chassis Intrusion Connector Location**

Pin	Description
1	+V3.3A_EC
2	CHASSIS_EC

**Table 3-7: Chassis Intrusion Connector Pinouts**

### 3.2.7 Digital I/O Connector

- CN Label:** DIO1
- CN Type:** 10-pin header, p=2.0 mm
- CN Location:** See **Figure 3-9**
- CN Pinouts:** See **Table 3-8**

The digital I/O connector provides programmable input and output for external devices. The digital I/O provides 4-bit output and 4-bit input.

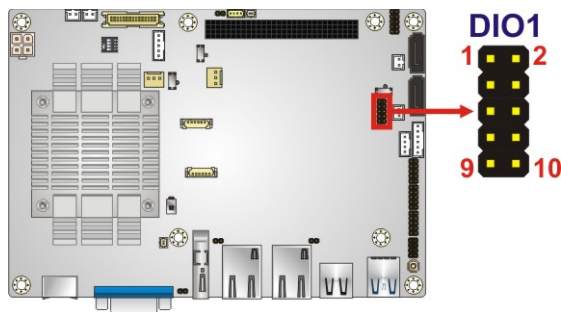

**Figure 3-9: Digital I/O Connector Location**

PIN NO.	DESCRIPTION	PIN NO.	DESCRIPTION
1	GND	2	+5V
3	DOUT3	4	DOUT2
5	DOUT1	6	DOUT0
7	DIN3	8	DIN2
9	DIN1	10	DINO

**Table 3-8: Digital I/O Connector Pinouts**

## NANO-BT EPIC SBC

### 3.2.8 Fan Connector (CPU)

- CN Label:** CPU\_FAN1
- CN Type:** 3-pin wafer, p=2.54 mm
- CN Location:** See **Figure 3-10**
- CN Pinouts:** See **Table 3-9**

The fan connector attaches to a CPU cooling fan.

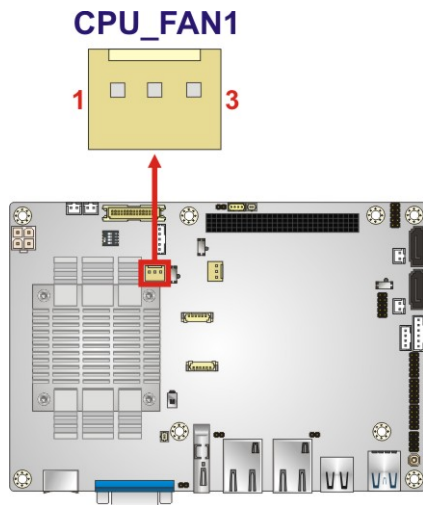

**Figure 3-10: CPU Fan Connector Location**

PIN NO.	DESCRIPTION
1	FAN_IN
2	VCC (+12 V)
3	GND

**Table 3-9: CPU Fan Connector Pinouts**



### 3.2.9 Fan Connector (System)

- CN Label:**        **SYS\_FAN1**
- CN Type:**        3-pin wafer, p=2.54 mm
- CN Location:**    See **Figure 3-11**
- CN Pinouts:**     See **Table 3-10**

Each fan connector attaches to a system cooling fan.

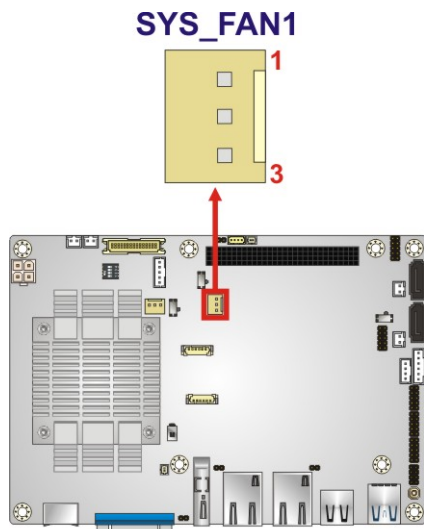

**Figure 3-11: System Fan Connector Location**

PIN NO.	DESCRIPTION
1	FAN_IN
2	VCC (+12 V)
3	GND

**Table 3-10: System Fan Connector Pinouts**

## NANO-BT EPIC SBC

### 3.2.10 Front Panel Connector

- CN Label:** CN11
- CN Type:** 6-pin wafer, p=2.0 mm
- CN Location:** See **Figure 3-12**
- CN Pinouts:** See **Table 3-11**

The front panel connector connects to the indicator LEDs on the computer's front panel.

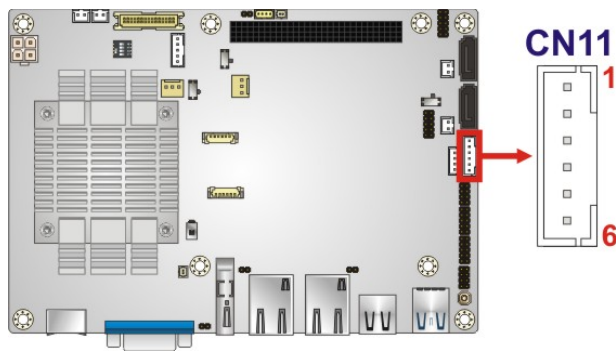

**Figure 3-12: Front Panel Connector Location**

PIN	DESCRIPTION	PIN	DESCRIPTION
1	VCC	4	PWR_LED-
2	GND	5	HDD_LED+
3	PWR_LED+	6	HDD_LED-

**Table 3-11: Front Panel Connector Pinouts**

### 3.2.11 IPMI LED Connector

- CN Label:** ID\_LED2
- CN Type:** 2-pin header, p=2.0 mm
- CN Location:** See **Figure 3-13**
- CN Pinouts:** See **Table 3-12**

The IPMI LED connector is used to connect to the IPMI LED indicator on the chassis.

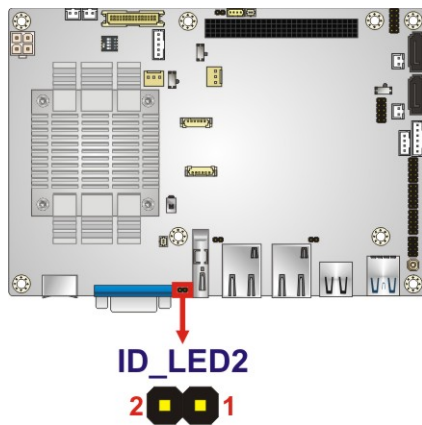

**Figure 3-13: IPMI LED Connector Location**

Pin	Description
1	ID_LED+
2	ID_LED-

**Table 3-12: IPMI LED Connector Pinouts**

## NANO-BT EPIC SBC

### 3.2.12 iRIS Module Slot (NANO-BT-i1 Models Only)

<b>CN Label:</b>	<b>IPMI1</b>
<b>CN Type:</b>	Half-size PCIe Mini slot
<b>CN Location:</b>	See <b>Figure 3-14</b>

The iRIS module slot is used to install the IEI iRIS-1010 IPMI 2.0 module. This slot is only available in NANO-BT-i1 models.



#### **WARNING:**

The iRIS module slot is designed to install the IEI iRIS-1010 IPMI 2.0 module only. DO NOT install other modules into the iRIS module slot. Doing so may cause damage to the NANO-BT.

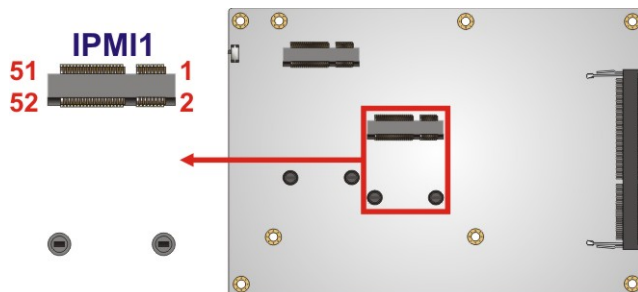
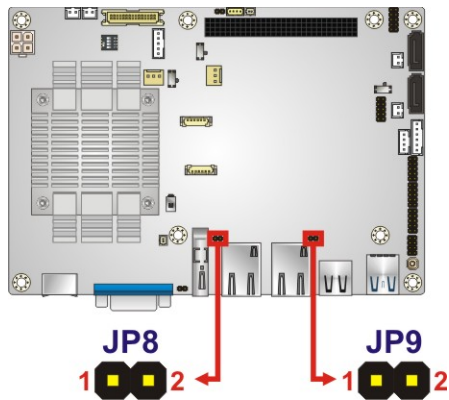

**Figure 3-14: iRIS Module Slot Location**

### 3.2.13 LAN LED Connectors

<b>CN Label:</b>	<b>JP8, JP9</b>
<b>CN Type:</b>	2-pin header, p=2.0 mm
<b>CN Location:</b>	See <b>Figure 3-15</b>
<b>CN Pinouts:</b>	See <b>Table 3-13</b> and <b>Table 3-14</b>

The LAN LED connectors are used to connect to the LAN LED indicators on the chassis to indicate users the link activities of the two LAN ports.



**Figure 3-15: LAN LED Connector Locations**

Pin	Description
1	VCC
2	L1_LINK_ACT-

**Table 3-13: LAN1 LED Connector (JP8) Pinouts**

Pin	Description
1	VCC
2	L2_LINK_ACT-

**Table 3-14: LAN2 LED Connector (JP9) Pinouts**

### 3.2.14 LVDS Connector

- CN Label:** CN2
- CN Type:** 30-pin crimp, p=1.25 mm
- CN Location:** See **Figure 3-16**
- CN Pinouts:** See **Table 3-15**

The LVDS connector is for an LCD panel connected to the board.



NANO-BT EPIC SBC

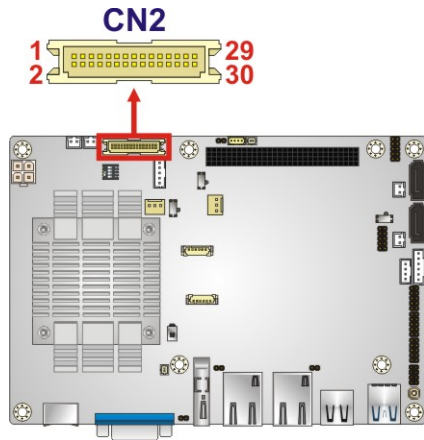

Figure 3-16: LVDS Connector Location

Pin	Description	Pin	Description
1	GND	2	GND
3	LVDS_A_TX0-P	4	LVDS_ A_TX0-N
5	LVDS_ A_TX1-P	6	LVDS_ A_TX1-N
7	LVDS_ A_TX2-P	8	LVDS_ A_TX2-N
9	LVDS_ A_TXCLK-P	10	LVDS_ A_TXCLK-N
11	LVDS_ A_TX3-P	12	LVDS_ A_TX3-N
13	GND	14	GND
15	LVDS_B_TX0-P	16	LVDS_ B_TX0-N
17	LVDS_ B_TX1-P	18	LVDS_ B_TX1-N
19	LVDS_ B_TX2-P	20	LVDS_ B_TX2-N
21	LVDS_ B_TXCLK-P	22	LVDS_ B_TXCLK-N
23	LVDS_ B_TX3-P	24	LVDS_ B_TX3-N
25	GND	26	GND
27	+LCD VCC	28	+LCD VCC
29	+LCD VCC	30	+LCD VCC

Table 3-15: LVDS Connector Pinouts

### 3.2.15 Memory Card Slot

- CN Label:** DIMM1
- CN Type:** DDR3 SO-DIMM slot
- CN Location:** See **Figure 3-17**

The SO-DIMM slot is for installing DDR3 Low Voltage SO-DIMM memory modules.

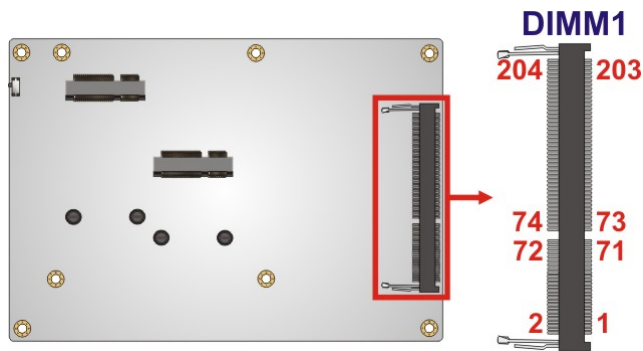
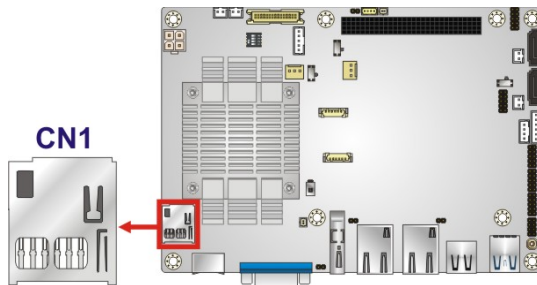

**Figure 3-17: Memory Card Slot Location**

### 3.2.16 microSD Card Slot (E38xx Models Only)

- CN Label:** CN1
- CN Type:** microSD slot
- CN Location:** See **Figure 3-14**

The microSD card slot is used to install microSD card. This slot is only available in E38xx models.



**Figure 3-18: microSD Card Slot Location**

## NANO-BT EPIC SBC

### 3.2.17 PCI-104 Connector

- CN Label:** PC104\_PLUS1
- CN Type:** PCI-104 connector
- CN Location:** See **Figure 3-19**
- CN Pinouts:** See **Table 3-16**

The PCI-104 connector is for installing a PCI-104 expansion card.

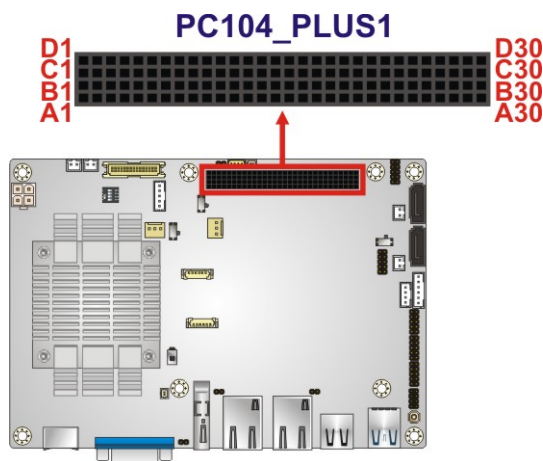

**Figure 3-19: PCI-104 Connector Location**

Pin	Row A	Row B	Row C	Row D
1	GND/5 V	TBD1	5 V	AD00
2	VI/O1	AD02	AD01	+5 V
3	AD05	GND	AD04	AD03
4	C/BE0#	AD07	GND	AD06
5	GND	AD09	AD08	GND
6	AD11	VI/O2	AD10	M66EN
7	AD14	AD13	GND	AD12
8	+3.3 V	C/BE1#	AD15	+3.3 V
9	SERR#	GND	SB0#	PAR
10	GND	PERR#	+3.3 V	SDONE
11	STOP#	+3.3 V	LOCK#	GND

Pin	Row A	Row B	Row C	Row D
12	+3.3 V	TRDY#	GND	DEVSEL#
13	FRAME#	GND	IRDY#	+3.3 V
14	GND	AD16	+3.3 V	C/BE2#
15	AD18	+3.3 V	AD17	GND
16	AD21	AD20	GND	AD19
17	+3.3 V	AD23	AD22	+3.3 V
18	IDSEL0	GND	IDSEL1	IDSEL2
19	AD24	C/BE3#	VI/O1	IDSEL3
20	GND	AD26	AD25	GND
21	AD29	+5 V	AD28	AD27
22	+5 V	AD30	GND	AD31
23	REQ0#	GND	REQ1#	VI/O2
24	GND	REQ2#	+5 V	GNT0#
25	GNT1#	VI/O3	GNT2#	GND
26	+5 V	CLK0	GND	CLK1
27	CLK2	+5 V	CLK3	GND
28	GND	INTD#	+5 V	RST#
29	+12 V	INTA#	INTB#	INTC#
30	-12 V	TBD2	TBD	GND/3.3 V

**Table 3-16: PCI-104 Connector Pinouts**

### 3.2.18 PCIe Mini Card Slot

- CN Label:** CN8
- CN Type:** PCIe Mini card slot
- CN Location:** See **Figure 3-20**
- CN Pinouts:** See **Table 3-17**

The PCIe Mini card slot is for installing PCIe Mini expansion cards, such as mSATA modules or Wi-Fi modules.

NANO-BT EPIC SBC

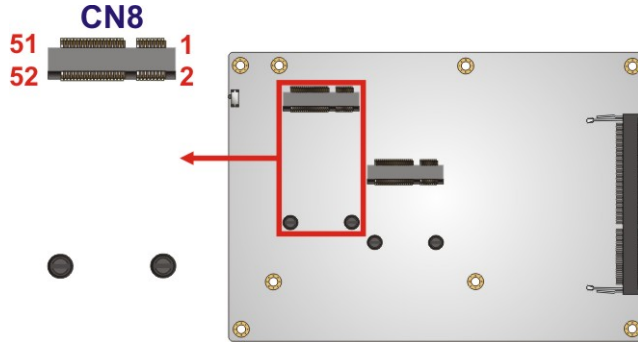

Figure 3-20: PCIe Mini Card Slot Location

Pin	Description	Pin	Description
1	PCIE_WAKE#	2	VCC3
3	N/C	4	GND
5	N/C	6	1.5 V
7	VCC3	8	N/C
9	GND	10	N/C
11	CLK-	12	N/C
13	CLK+	14	N/C
15	GND	16	N/C
17	BUF_PLT_RST#	18	GND
19	N/C	20	VCC3
21	GND	22	BUF_PLT_RST#
23	PCIE_RX4DN_M	24	VCC3
25	PCIE_RX4DP_M	26	GND
27	GND	28	1.5 V
29	GND	30	SMBCLK
31	PCIE_TX4DN_CM	32	SMBDATA
33	PCIE_TX4DP_CM	34	GND
35	GND	36	USB3D3-
37	GND	38	USB3D3+
39	VCC3	40	GND
41	VCC3	42	N/C
43	GND	44	RF_LINK#
45	N/C	46	BLUELED#



Pin	Description	Pin	Description
47	N/C	48	1.5 V
49	N/C	50	GND
51	M-SATADET	52	VCC3

**Table 3-17: PCIe Mini Card Slot Pinouts**

### 3.2.19 Power Button Connector

- CN Label:** PWR\_BTN1
- CN Type:** 2-pin wafer, p=2.0 mm
- CN Location:** See Figure 3-21
- CN Pinouts:** See Table 3-18

The power button connector is connected to a power switch on the system chassis.

#### PWR\_BTN1

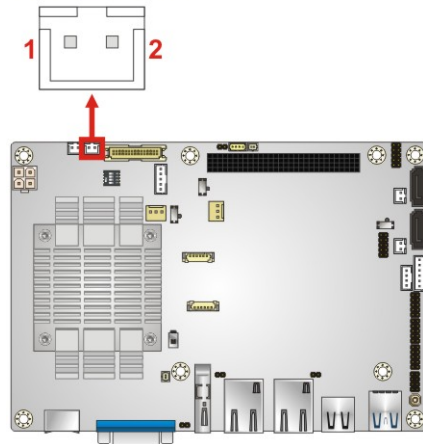

**Figure 3-21: Power Button Location**

Pin	Description
1	PWRBTN_SW#
2	GND

**Table 3-18: Power Button Pinouts**

## NANO-BT EPIC SBC

### 3.2.20 Power Button

<b>CN Label:</b>	<b>PWR_SW1</b>
<b>CN Type:</b>	Push button
<b>CN Location:</b>	See <b>Figure 3-22</b>

The on-board power button controls system power.

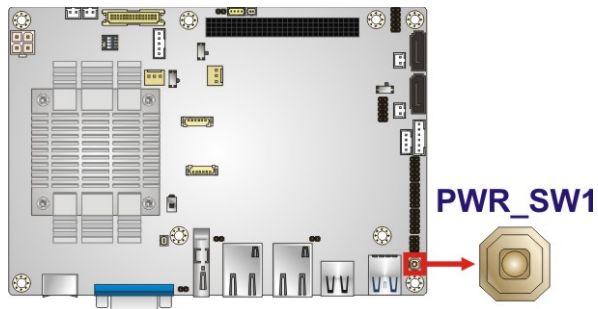
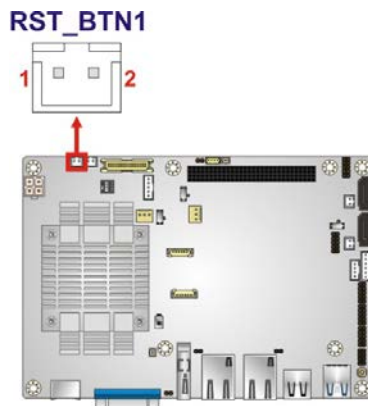

**Figure 3-22: Power Button Location**

### 3.2.21 Reset Button Connector

<b>CN Label:</b>	<b>RST_BTN1</b>
<b>CN Type:</b>	2-pin wafer, p=2.0 mm
<b>CN Location:</b>	See <b>Figure 3-23</b>
<b>CN Pinouts:</b>	See <b>Table 3-19</b>

The reset button connector is connected to a reset switch on the system chassis.



**Figure 3-23: Reset Button Connector Location**

Pin	Description
1	PM_SYSRST_R#
2	GND

**Table 3-19: Reset Button Connector Pinouts**

### 3.2.22 SATA 3Gb/s Drive Connectors

- CN Label:** SATA1, SATA2
- CN Type:** 7-pin SATA drive connectors
- CN Location:** See **Figure 3-24**
- CN Pinouts:** See **Table 3-20**

The SATA drive connectors can be connected to SATA drives.

**NANO-BT EPIC SBC**

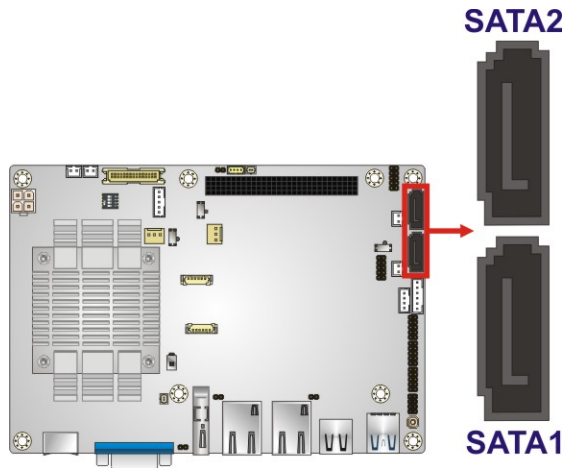

**Figure 3-24: SATA 3Gb/s Drive Connector Locations**

Pin	Description
1	GND
2	SATA_TX+
3	SATA_TX-
4	GND
5	SATA_RX-
6	SATA_RX+
7	GND

**Table 3-20: SATA 3Gb/s Drive Connector Pinouts**

**3.2.23 SATA Power Connectors**

**CN Label:** SATA\_PWR1, SATA\_PWR2

**CN Type:** 2-pin wafer, p=2.0 mm

**CN Location:** See **Figure 3-25**

**CN Pinouts:** See **Table 3-21**

Use the SATA Power Connector to connect to SATA device power connections.

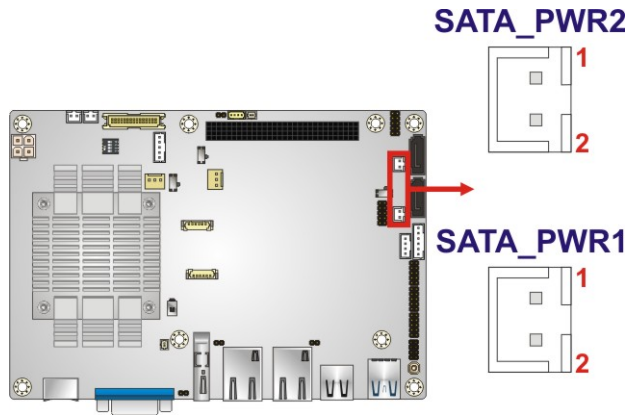

**Figure 3-25: SATA Power Connector Locations**

Pin	Description
1	+5VS
2	GND

**Table 3-21: SATA Power Connector Pinouts**



## NANO-BT EPIC SBC

### 3.2.24 Serial Port Connectors, RS-232

**CN Label:** COM1, COM2, COM3

**CN Type:** 10-pin header, p=2.0 mm

**CN Location:** See Figure 3-26

**CN Pinouts:** See Table 3-22

The connector provides RS-232 port connection.

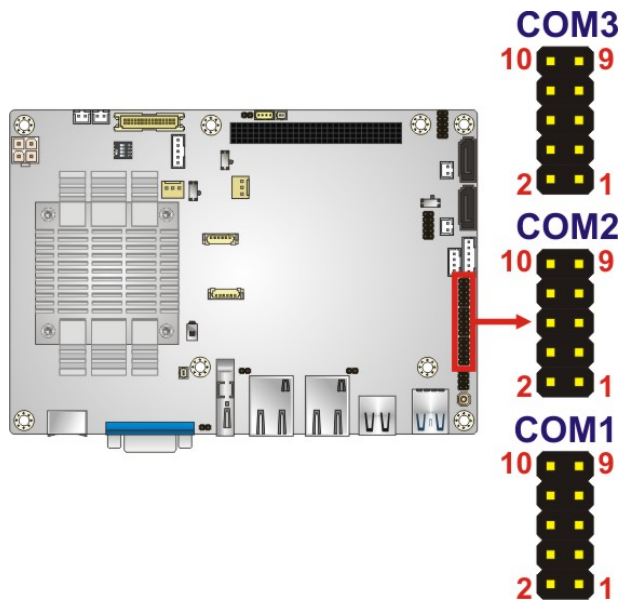

**Figure 3-26: RS-232 Serial Port Connector Locations**

PIN NO.	DESCRIPTION	PIN NO.	DESCRIPTION
1	DCD	2	DSR
3	SIN	4	RTS
5	SOUT	6	CTS
7	DTR	8	RI
9	GND	10	GND

**Table 3-22: RS-232 Serial Port Connector Pinouts**

**3.2.25 Serial Port Connector, RS-422/485**

- CN Label:** COM4
- CN Type:** 4-pin wafer, p=2.0 mm
- CN Location:** See **Figure 3-27**
- CN Pinouts:** See **Table 3-23**

Used for RS-422/485 communications.

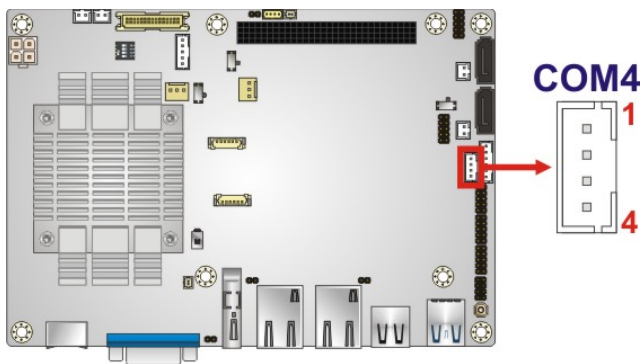

**Figure 3-27: RS-422/485 Connector Location**

PIN NO.	DESCRIPTION
1	RXD422-
2	RXD422+
3	TXD422+/TXD485+
4	TXD422-/TXD485-

**Table 3-23: RS-422/485 Connector Pinouts**

Use the optional RS-422/485 cable to connect to a serial device. The pinouts of the D-sub 9 connector are listed below.

NANO-BT EPIC SBC

RS-422 Pinouts	RS-485 Pinouts

Table 3-24: RS-422/485 Pinouts of D-sub 9 Connector

3.2.26 SMBus Connector

- CN Label:** CN5
- CN Type:** 4-pin wafer, p=1.25 mm
- CN Location:** See Figure 3-28
- CN Pinouts:** See Table 3-25

The SMBus (System Management Bus) connector provides low-speed system management communications.

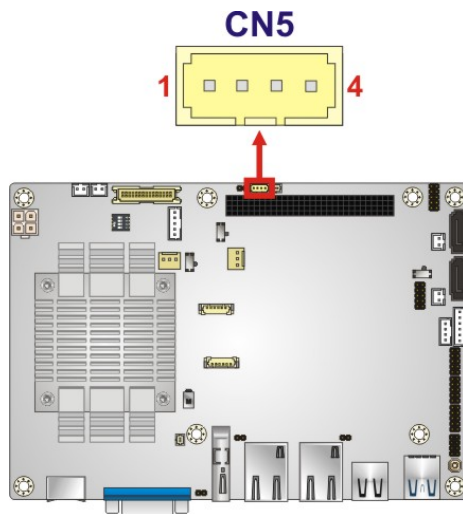

Figure 3-28: SMBus Connector Location

PIN	DESCRIPTION
1	GND
2	SMB_DATA

PIN	DESCRIPTION
3	SMB_CLK
4	+5 V

**Table 3-25: SMBus Connector Pinouts**

### 3.2.27 SPI Flash Connector

- CN Label:** JSPI1
- CN Type:** 6-pin wafer, p=1.25 mm
- CN Location:** See **Figure 3-29**
- CN Pinouts:** See **Table 3-26**

The SPI flash connector is used to flash the SPI ROM.

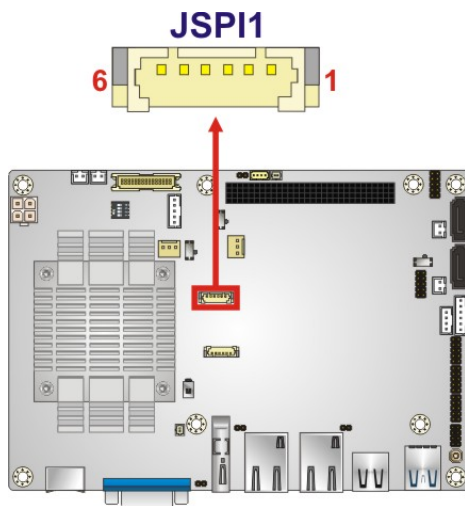

**Figure 3-29: SPI Flash Connector Location**

PIN NO.	DESCRIPTION	PIN NO.	DESCRIPTION
1	+1.8 VA	4	SPI_CLK_SW
2	SPI_CS	5	SPI_SI_SW
3	SPI_SO_SW	6	GND

**Table 3-26: SPI Flash Connector Pinouts**

## NANO-BT EPIC SBC

### 3.2.28 SPI Flash Connector, EC

- CN Label:** JSPI2
- CN Type:** 6-pin wafer, p=1.25 mm
- CN Location:** See **Figure 3-30**
- CN Pinouts:** See **Table 3-27**

The SPI flash connector is used to flash the EC ROM.

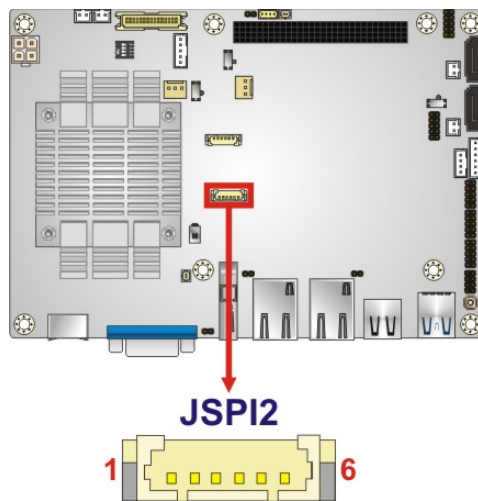

**Figure 3-30: SPI EC Flash Connector Location**

PIN NO.	DESCRIPTION	PIN NO.	DESCRIPTION
1	+3.3 A	4	SPI_CLK_SW_EC
2	SPI_CS#0_CN_EC	5	SPI_SI_SW_EC
3	SPI_SO_SW_EC	6	GND

**Table 3-27: SPI EC Flash Connector Pinouts**



**3.2.29 USB 2.0 Connector**

- CN Label:** USB1
- CN Type:** 8-pin header , p=2.0 mm
- CN Location:** See **Figure 3-31**
- CN Pinouts:** See **Table 3-28**

The USB 2.0 connector connects to USB 2.0 devices. Each pin header provides two USB 2.0 ports.

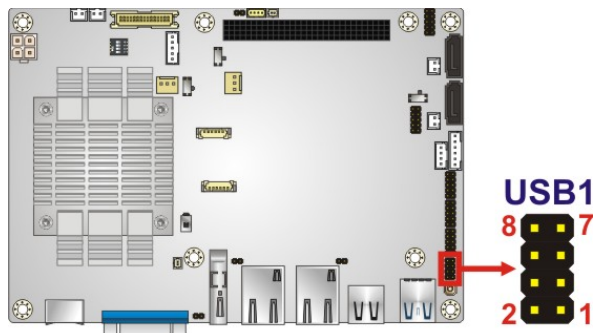

**Figure 3-31: USB 2.0 Connector Location**

PIN NO.	DESCRIPTION	PIN NO.	DESCRIPTION
1	+VCC_USB45	2	GND
3	DATA4-	4	DATA5+
5	DATA4+	6	DATA5-
7	GND	8	+VCC_USB45

**Table 3-28: USB 2.0 Connector Pinouts**

**NANO-BT EPIC SBC**

**3.3 External Peripheral Interface Connector Panel**

The figure below shows the external peripheral interface connector (EPIC) panel. The EPIC panel consists of the following:

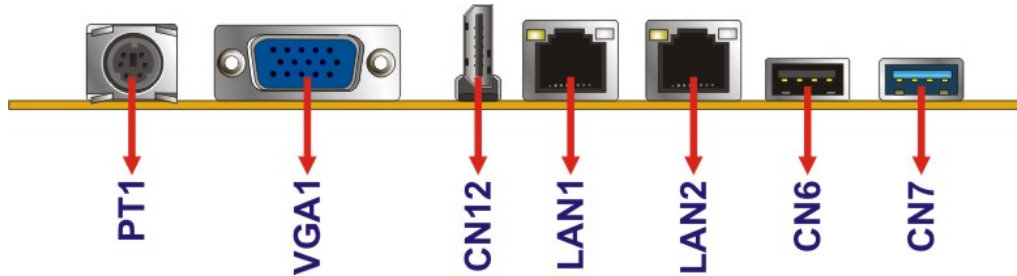

**Figure 3-32: External Peripheral Interface Connector**

**3.3.1 Ethernet Connectors**

- CN Label:** LAN1, LAN2
- CN Type:** RJ-45
- CN Location:** See Figure 3-32
- CN Pinouts:** See Table 3-29 and Table 3-30

A 10/100/1000 Mb/s connection can be made to a Local Area Network. The LAN1 Ethernet connector supports IPMI 2.0.

Pin	Description	Pin	Description
G1	IO_GND	R2	TRD1N0
G2	IO_GND	R3	TRD1P1
L1	L1_100-	R4	TRD1N1
L2	L1_1000-	R5	N95788738
L3	L1_LINK_ACT-	R6	N95788617
L4	N100494685	R7	TRD1P2
N1	NC	R8	TRD1N2
N2	NC	R9	TRD1P3
R1	TRD1P0	R10	TRD1N3

**Table 3-29: LAN1 Ethernet Connector Pinouts**

Pin	Description	Pin	Description
G1	IO_GND_1	R2	TRD2N0
G2	IO_GND_1	R3	TRD2P1
L1	L2_100-	R4	TRD2N1
L2	L2_1000-	R5	N95934519
L3	L2_LINK_ACT-	R6	N95934513
L4	N100495197	R7	TRD2P2
N1	NC	R8	TRD2N2
N2	NC	R9	TRD2P3
R1	TRD2P0	R10	TRD2N3

**Table 3-30: LAN2 Ethernet Connector Pinouts**

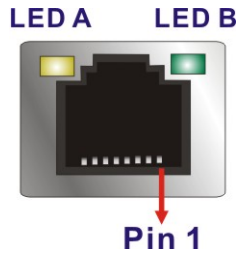

**Figure 3-33: Ethernet Connector**

LED	Description	LED	Description
A	on: linked blinking: data is being sent/received	B	off: 10 Mb/s green: 100 Mb/s orange: 1000 Mb/s

**Table 3-31: Connector LEDs**

### 3.3.2 HDMI Connector

- CN Label:** CN12
- CN Type:** 23-pin HDMI port
- CN Location:** See **Figure 3-32**
- CN Pinouts:** See **Table 3-32**

The HDMI connector can connect to an HDMI device.

## NANO-BT EPIC SBC

Pin	Description	Pin	Description
1	HDMI_DATA2	2	GND
3	HDMI_DATA2#	4	HDMI_DATA1
5	GND	6	HDMI_DATA1#
7	HDMI_DATA0	8	GND
9	HDMI_DATA0#	10	HDMI_CLK
11	GND	12	HDMI_CLK#
13	N/C	14	N/C
15	HDMI_SCL	16	HDMI_SDA
17	GND	18	+5V
19	HDMI_HPD	20	HDMI_GND
21	HDMI_GND	22	HDMI_GND
23	HDMI_GND		

**Table 3-32: HDMI Connector Pinouts**

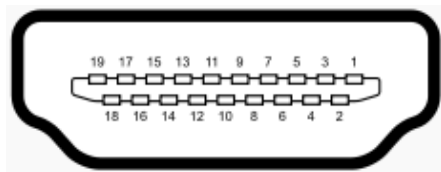
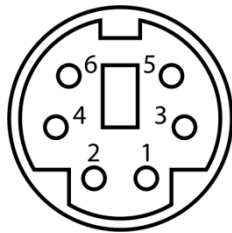

**Figure 3-34: HDMI Connector**

### 3.3.3 Keyboard/Mouse Connector

- CN Label:** PT1
- CN Type:** PS/2
- CN Location:** See **Figure 3-32**
- CN Pinouts:** See **Table 3-33**

The keyboard and mouse connector is a standard PS/2 connector.



**Figure 3-35: PS/2 Pinout and Configuration**

Pin	Description
1	KB DATA
2	MS DATA
3	GND
4	VCC
5	KB CLOCK
6	MS CLOCK

**Table 3-33: Keyboard Connector Pinouts**

### 3.3.4 USB 2.0 Connector

- CN Label:** CN6
- CN Type:** USB 2.0 port
- CN Location:** See **Figure 3-32**
- CN Pinouts:** See **Table 3-34**

The USB connector can be connected to a USB device.

Pin	Description	Pin	Description
1	USB3_PWR1	4	GND
2	DATA1_N	5	USB_GND
3	DATA1_P	6	USB_GND

**Table 3-34: USB 2.0 Port Pinouts**



## NANO-BT EPIC SBC

### 3.3.5 USB 3.0 Connector

- CN Label:** CN7
- CN Type:** USB 3.0 port
- CN Location:** See **Figure 3-32**
- CN Pinouts:** See **Table 3-35**

The USB connector can be connected to a USB device.

Pin	Description	Pin	Description
1	USB3_PWR1	6	USB3P0_RXDP1
2	USB2P0_DM1_L	7	USB_GND
3	USB2P0_DP1_L	8	USB3P0_TXDN1_C
4	GND	9	USB3P0_TXDP1_C
5	USB3P0_RXDN1		

**Table 3-35: USB 3.0 Port Pinouts**

### 3.3.6 VGA Connector

- CN Label:** VGA1
- CN Type:** 15-pin Female
- CN Location:** See **Figure 3-32**
- CN Pinouts:** See **Table 3-36** and **Figure 3-36**

Both VGA connectors can be connected to monitors that accept standard VGA input for easy dual display setup. The VGA connectors support up to 1920 x 1200 resolutions.

PIN	DESCRIPTION	PIN	DESCRIPTION
V1	RED	V2	GREEN
V3	BLUE	V4	NC
V5	GND	V6	GND
V7	GND	V8	GND
V9	VCC	V10	GND

PIN	DESCRIPTION	PIN	DESCRIPTION
V11	NC	V12	DDCDA
V13	HSYNC	V14	VSYNC
V15	DDCCLK		

**Table 3-36: VGA Connector Pinouts**

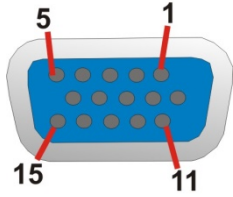

**Figure 3-36: VGA Connector**

Chapter

4

# Installation

---

## 4.1 Anti-static Precautions

---



### WARNING:

Failure to take ESD precautions during the installation of the NANO-BT may result in permanent damage to the NANO-BT and severe injury to the user.

---

Electrostatic discharge (ESD) can cause serious damage to electronic components, including the NANO-BT. Dry climates are especially susceptible to ESD. It is therefore critical that whenever the NANO-BT or any other electrical component is handled, the following anti-static precautions are strictly adhered to.

- **Wear an anti-static wristband:** - Wearing a simple anti-static wristband can help to prevent ESD from damaging the board.
- **Self-grounding:**- Before handling the board touch any grounded conducting material. During the time the board is handled, frequently touch any conducting materials that are connected to the ground.
- **Use an anti-static pad:** When configuring the NANO-BT, place it on an anti-static pad. This reduces the possibility of ESD damaging the NANO-BT.
- **Only handle the edges of the PCB:-:** When handling the PCB, hold the PCB by the edges.

## 4.2 Installation Considerations

---



### NOTE:

The following installation notices and installation considerations should be read and understood before installation. All installation notices must be strictly adhered to. Failing to adhere to these precautions may lead to severe damage and injury to the person performing the installation.

---

## NANO-BT EPIC SBC



### **WARNING:**

The installation instructions described in this manual should be carefully followed in order to prevent damage to the components and injury to the user.

Before and during the installation please **DO** the following:

- Read the user manual:
  - The user manual provides a complete description of the NANO-BT installation instructions and configuration options.
- Wear an electrostatic discharge cuff (ESD):
  - Electronic components are easily damaged by ESD. Wearing an ESD cuff removes ESD from the body and helps prevent ESD damage.
- Place the NANO-BT on an antistatic pad:
  - When installing or configuring the motherboard, place it on an antistatic pad. This helps to prevent potential ESD damage.
- Turn all power to the NANO-BT off:
  - When working with the NANO-BT, make sure that it is disconnected from all power supplies and that no electricity is being fed into the system.

Before and during the installation of the NANO-BT **DO NOT**:

- Remove any of the stickers on the PCB board. These stickers are required for warranty validation.
- Use the product before verifying all the cables and power connectors are properly connected.
- Allow screws to come in contact with the PCB circuit, connector pins, or its components.



### 4.2.1 SO-DIMM Installation

To install an SO-DIMM, please follow the steps below and refer to Figure 4-1.

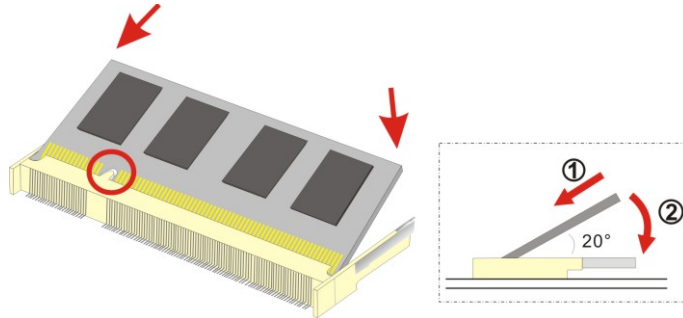

Figure 4-1: SO-DIMM Installation

- Step 1:** Locate the **SO-DIMM socket** on the solder side of the NANO-BT. Place the board on an anti-static mat.
- Step 2:** **Align the SO-DIMM with the socket.** Align the notch on the memory with the notch on the memory socket.
- Step 3:** Insert the SO-DIMM. Push the memory in at a 20° angle. (See Figure 4-1)
- Step 4:** Seat the SO-DIMM. Gently push downwards and the arms clip into place. (See Figure 4-1)

### 4.2.2 iRIS-1010 Module Installation (Optional)



#### **WARNING:**

The iRIS module slot is designed to install the IEI iRIS-1010 IPMI 2.0 module only. DO NOT install other modules into the iRIS module slot. Doing so may cause damage to the NANO-BT.

To install the iRIS-1010 module, please follow the steps below and refer to **Figure 4-2**.

## NANO-BT EPIC SBC

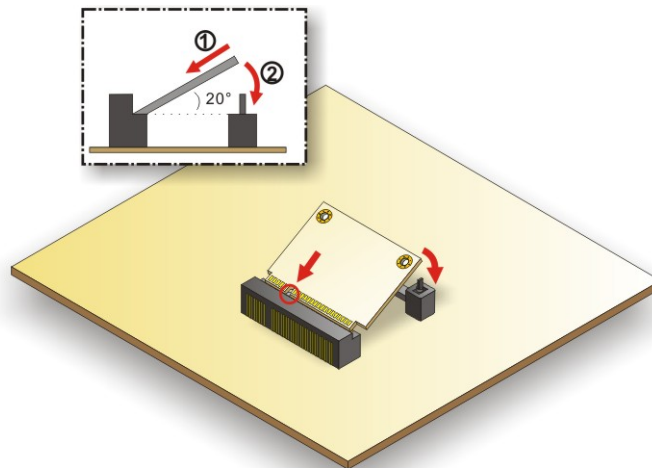

Figure 4-2: iRIS-1010 Module Installation

- Step 1:** Locate the iRIS module slot on the solder side. See Figure 3-14.
- Step 2:** **Insert into the socket at an angle.** Line up the notch on the RIS-1010 module with the notch on the connector. Slide the RIS-1010 module into the socket at an angle of about 20°.
- Step 3:** **Push down until the RIS-1010 module clips into place.** Push the other end of the RIS-1010 module down until it clips into place on the plastic connector.



**NOTE:**

After installing the iRIS-1010 module, use **LAN1** port to establish a network connection. Please refer to **Section 4.5** for IPMI setup procedures.

### 4.2.3 PCIe Mini Card Installation

To install the PCIe Mini card, please refer to the diagram and instructions below.

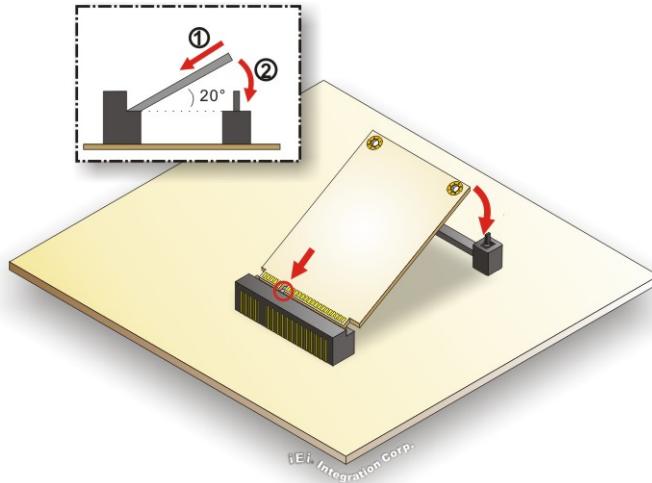

Figure 4-3: PCIe Mini Card Installation

- Step 1:** Insert into the socket at an angle. Line up the notch on the card with the notch on the connector. Slide the PCIe Mini card into the socket at an angle of about 20°.
- Step 2:** Push down until the card clips into place. Push the other end of the card down until it clips into place on the plastic connector.

## 4.3 System Configuration

The NANO-BT is a jumperless single board computer. The system configuration is controlled by buttons and switches. The system configuration must be performed before installation.

### 4.3.1 AT/ATX Power Mode Setting

The AT and ATX power mode selection is made through the AT/ATX power mode switch which is shown in **Figure 4-4**.

NANO-BT EPIC SBC

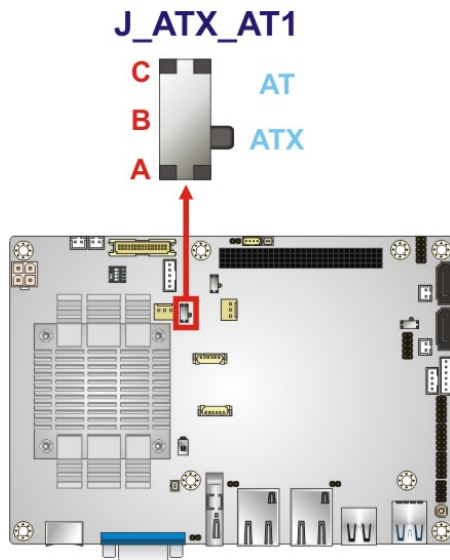

Figure 4-4: AT/ATX Power Mode Switch Location

4.3.2 Clear CMOS Button

To reset the BIOS, remove the on-board battery and press the clear CMOS button for three seconds or more. The clear CMOS button location is shown in **Figure 4-5**.

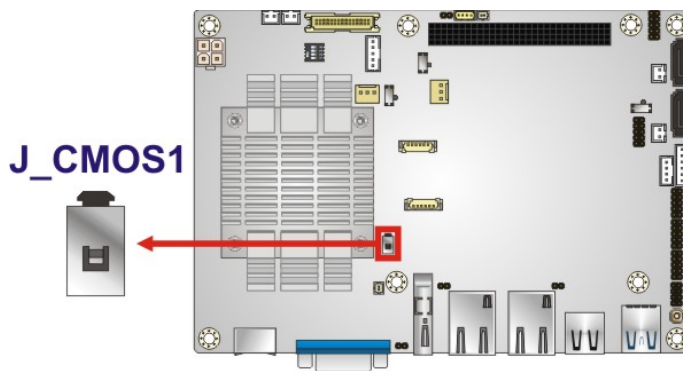

Figure 4-5: Clear CMOS Button Location

### 4.3.3 LVDS Panel Resolution Selection

Use the SW1 DIP switch to select the resolution of the LCD panel connected to the LVDS connector.

<b>SW1 (4-3-2-1)</b>	<b>Description</b>
0000	800x600 18-bit (Default)
0001	1024x768 18-bit
0010	1024x768 24-bit
0011	1280x768 18-bit
0100	1280x800 18-bit
0101	1280x960 18-bit
0110	1280x1024 48-bit
0111	1366x768 18-bit
1000	1366x768 24-bit
1001	1440x900 48-bit
1010	1400x1050 48-bit
1011	1600x900 48-bit
1100	1680x1050 48-bit
1101	1600x1200 48-bit
1110	1920x1080 48-bit
1111	1920x1200 48-bit

\*ON=0, OFF=1

**Table 4-1: LVDS Panel Resolution Selection**



## NANO-BT EPIC SBC

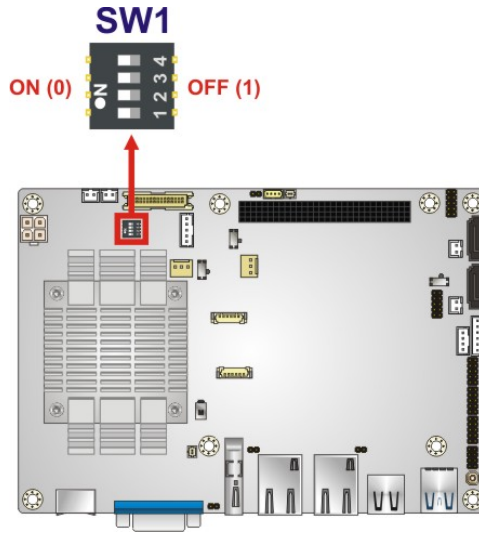

Figure 4-6: LVDS Panel Resolution Selection Switch Location

### 4.3.4 LCD Voltage Selection

The LCD voltage selection switch sets the voltage of the power supplied to the LCD panel.

The LCD Voltage Selection settings are shown in **Table 4-2**.

Setting	Description
A-B	+3.3 V (Default)
B-C	+5.0 V

Table 4-2: LCD Voltage Selection Switch Settings

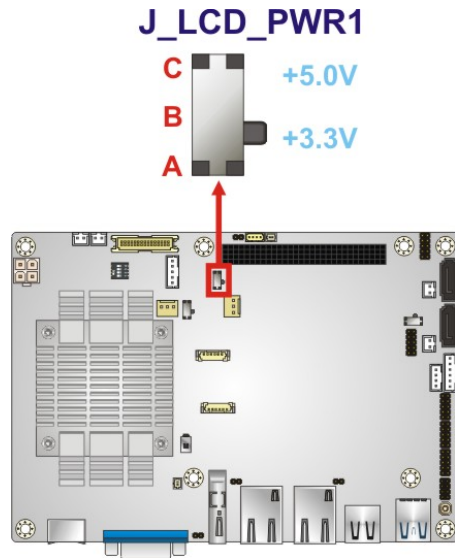

**Figure 4-7: LCD Voltage Selection Switch Location**

### 4.3.5 mSATA/SATA Selection

Use the J\_SATA1 switch to select whether to automatically detect mSATA devices.

Setting	Description
A-B	Automatically detect mSATA device (Default)
B-C	Enable mSATA device

**Table 4-3: mSATA/SATA Switch Settings**

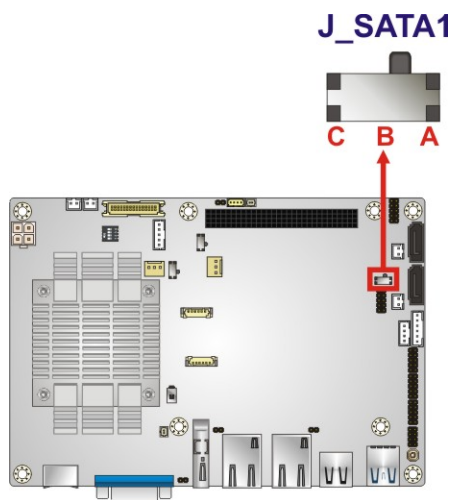

**Figure 4-8: mSATA/SATA Switch Location**

## NANO-BT EPIC SBC

### 4.3.6 PCI-104 Voltage Selection

Use the J\_PCI104 switch to select the voltage supplied to the PCI-104 expansion module.

Setting	Description
A-B	+3.3 V (Default)
B-C	+5.0 V

Table 4-4: PCI-104 Voltage Switch Settings

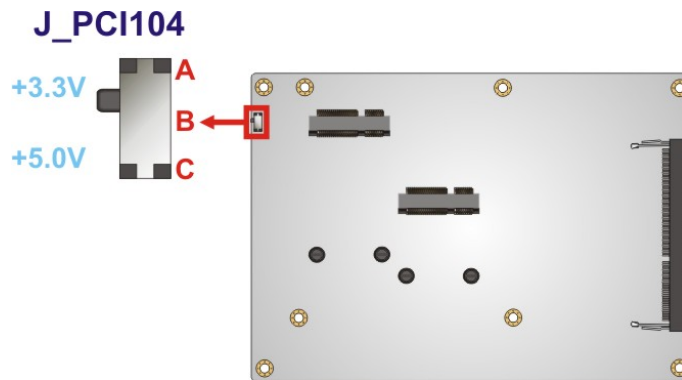

Figure 4-9: PCI-104 Voltage Switch Location

### 4.3.7 USB Power Select

The USB power selection is made through the BIOS option in “Chipset → South Bridge” BIOS menu. Use the **USB Power SW1** BIOS option to configure the power source to the following USB ports:

- CN7 (external USB 3.0 port)
- CN6 (external USB 2.0 port)
- USB1 (internal USB 2.0 port)

Please refer to **Section 5.4.2** for detailed information.

## 4.4 Internal Peripheral Device Connections

This section outlines the installation of peripheral devices to the on-board connectors.

### 4.4.1 AT Power Connection

Follow the instructions below to connect the NANO-BT to an AT power supply.



#### WARNING:

Disconnect the power supply power cord from its AC power source to prevent a sudden power surge to the NANO-BT.

---

**Step 1:** **Locate the power cable.** The power cable is shown in the packing list in Chapter 2.

**Step 2:** **Connect the Power Cable to the Motherboard.** Connect the 4-pin (2x2) Molex type power cable connector to the +12V power connector on the motherboard.

See Figure 4-10.

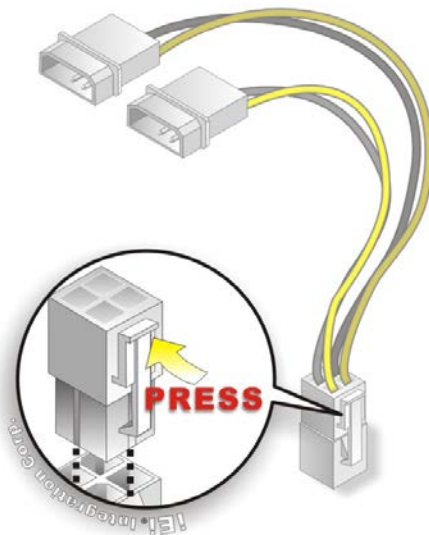
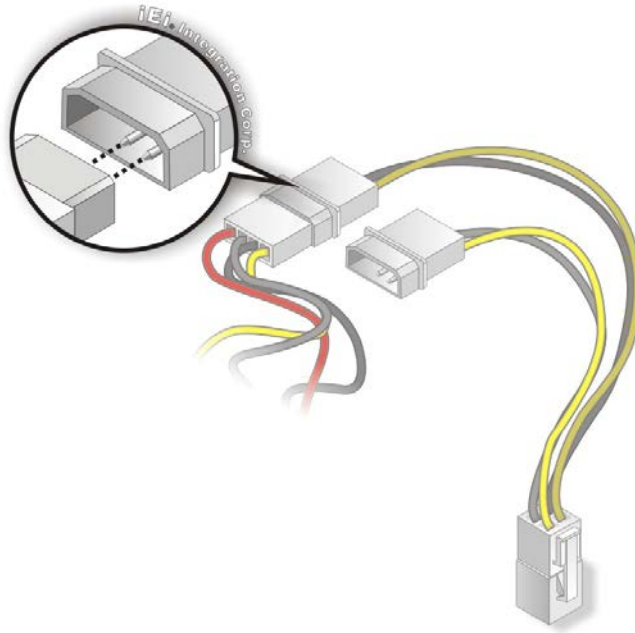

Figure 4-10: Power Cable to Motherboard Connection

## NANO-BT EPIC SBC

**Step 3: Connect Power Cable to Power Supply.** Connect one of the 4-pin (1x4) Molex type power cable connectors to an AT power supply. See **Figure 4-11**.



**Figure 4-11: Connect Power Cable to Power Supply**

### 4.4.2 SATA Drive Connection

The NANO-BT is shipped with two SATA drive cables. To connect the SATA drive to the connector, please follow the steps below.



**Step 1:** Locate the SATA connector and the SATA power connector. The locations of the connectors are shown in Chapter 3.

**Step 2:** **Insert the cable connector.** Insert the cable connector into the on-board SATA drive connector and the SATA power connector. See **Figure 4-12**.

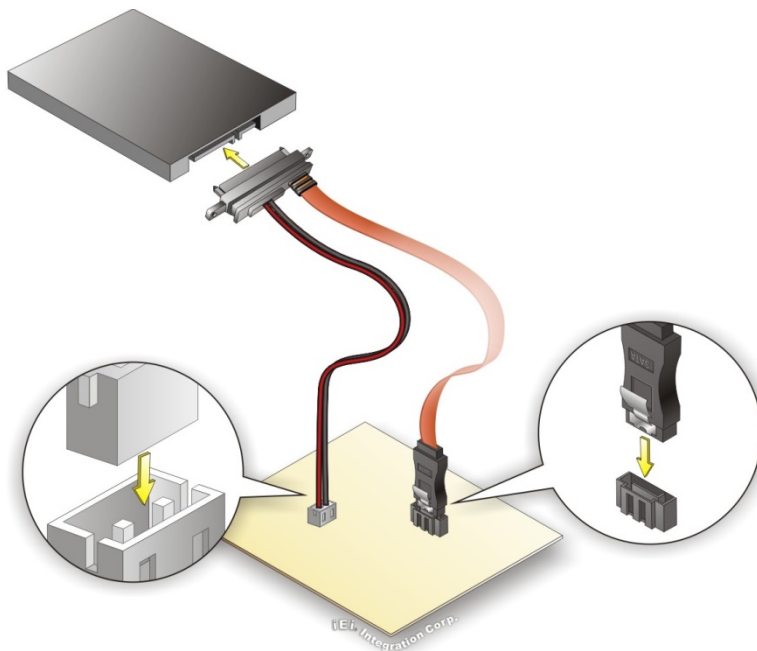

**Figure 4-12: SATA Drive Cable Connection**

**Step 3:** **Connect the cable to the SATA disk.** Connect the connector on the other end of the cable to the connector at the back of the SATA drive. See **Figure 4-12**.

**Step 4:** To remove the SATA cable from the SATA connector, press the clip on the connector at the end of the cable.

#### 4.4.3 Single RS-232 Cable Connection

The single RS-232 cable consists of one serial port connector attached to a serial communications cable that is then attached to a D-sub 9 male connector that is mounted onto a bracket. To install the single RS-232 cable, please follow the steps below.

## NANO-BT EPIC SBC

**Step 1:** **Locate the RS-232 connector.** The location of the RS-232 connector is shown in **Chapter 3**.

**Step 2:** **Insert the cable connector.** Align pin 1 on the on-board serial port pin header with pin 1 on the serial port connector. Pin 1 on the serial port connector is indicated with a white dot. Insert the connector into the serial port pin header. See Figure 4-13.

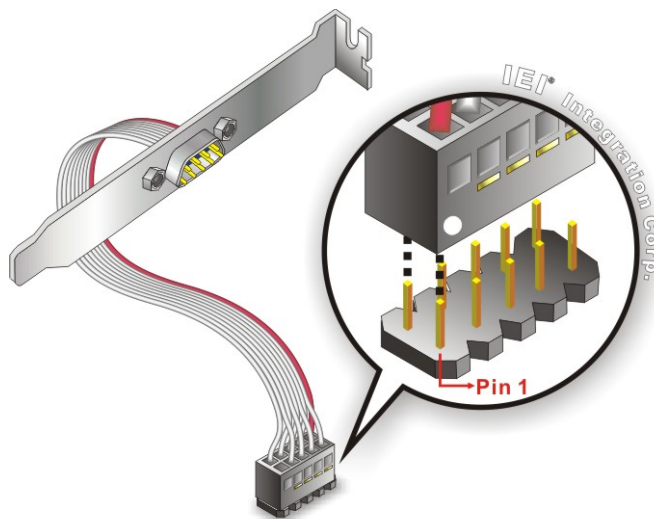

**Figure 4-13: Single RS-232 Cable Installation**

**Step 3:** **Secure the bracket.** The single RS-232 connector has one D-sub 9 male connector secured to a bracket. To secure the bracket to the chassis please refer to the reference material that came with the chassis.

### 4.5 IPMI Setup Procedure (for NANO-BT-i1 Models Only)

The NANO-BT-i1 features Intelligent Platform Management Interface (IPMI) that helps lower the overall costs of server management by enabling users to maximize IT resources, save time and manage multiple systems. The NANO-BT-i1 supports IPMI 2.0 through the optional iRIS-1010 module. Follow the steps below to setup IPMI.

### 4.5.1 Managed System Hardware Setup

The hardware configuration of the managed system (NANO-BT) is described below.

**Step 1:** Install an iRIS-1010 module to the IPMI module socket (refer to **Section 4.2.2**).

**Step 2:** Make sure a DDR3L SO-DIMM is installed in the SO-DIMM socket.

**Step 3:** Connect an Ethernet cable to the RJ-45 connector labeled **LAN1** (**Figure 3-32**).

Chapter

5

# BIOS

---

## 5.1 Introduction

The BIOS is programmed onto the BIOS chip. The BIOS setup program allows changes to certain system settings. This chapter outlines the options that can be changed.



### NOTE:

Some of the BIOS options may vary throughout the life cycle of the product and are subject to change without prior notice.

---

### 5.1.1 Starting Setup

The UEFI BIOS is activated when the computer is turned on. The setup program can be activated in one of two ways.

1. Press the **DEL** or **F2** key as soon as the system is turned on or
2. Press the **DEL** or **F2** key when the “**Press DEL or F2 to enter SETUP**” message appears on the screen.

If the message disappears before the **DEL** or **F2** key is pressed, restart the computer and try again.

### 5.1.2 Using Setup

Use the arrow keys to highlight items, press **ENTER** to select, use the PageUp and PageDown keys to change entries, press **F1** for help and press **ESC** to quit. Navigation keys are shown in **Table 5-1**.

Key	Function
Up arrow	Move to previous item
Down arrow	Move to next item
Left arrow	Move to the item on the left hand side
Right arrow	Move to the item on the right hand side



## NANO-BT EPIC SBC

Key	Function
+	Increase the numeric value or make changes
-	Decrease the numeric value or make changes
Esc key	Main Menu – Quit and not save changes into CMOS Status Page Setup Menu and Option Page Setup Menu -- Exit current page and return to Main Menu
F1 key	General help, only for Status Page Setup Menu and Option Page Setup Menu
F2 key	Load previous values
F3 key	Load optimized defaults
F4 key	Save changes and Exit BIOS

**Table 5-1: BIOS Navigation Keys**

### 5.1.3 Getting Help

When **F1** is pressed a small help window describing the appropriate keys to use and the possible selections for the highlighted item appears. To exit the Help Window press **Esc** or the **F1** key again.

### 5.1.4 Unable to Reboot after Configuration Changes

If the computer cannot boot after changes to the system configuration is made, CMOS defaults. Use the clear CMOS button described in **Chapter 4**.

### 5.1.5 BIOS Menu Bar

The **menu bar** on top of the BIOS screen has the following main items:

- Main – Changes the basic system configuration.
- Advanced – Changes the advanced system settings.
- Chipset – Changes the chipset settings.
- Boot – Changes the system boot configuration.

- Security – Sets User and Supervisor Passwords.
- Save & Exit – Selects exit options and loads default settings

The following sections completely describe the configuration options found in the menu items at the top of the BIOS screen and listed above.

## 5.2 Main

The **Main** BIOS menu (**BIOS Menu 1**) appears when the **BIOS Setup** program is entered.

The **Main** menu gives an overview of the basic system information.

Aptio Setup Utility - Copyright (C) 2013 American Megatrends, Inc.		
Main	Advanced	Chipset Security Boot Save & Exit
BIOS Information		Set the Date. Use Tab to switch between Data elements.
BIOS Vendor	American Megatrends	
Core Version	5.009	
Compliancy	UEFI 2.3;PI1.2	
Project Version	B348AI12.ROM	
Build Date	04/20/2015 18:18:06	
iWDD Vendor		iEi
iWDD Version	B348ER12.bin	
CPU Configuration		
Microcode Patch	901	
BayTrail SoC	D0 Stepping	-----
Memory Information		←→: Select Screen
Total Memory	2048 MB (LPDDR3)	↑ ↓: Select Item
TXE Information		EnterSelect
Sec RC Version	00.05.00.00	+ -: Change Opt.
TXE FW Version	01.00.02.1060	F1: General Help
System Date	[Wed 05/27/2015]	F2: Previous Values
System Time	[15:10:27]	F3: Optimized Defaults
		F4: Save & Exit
		ESC: Exit
Version 2.16.1242. Copyright (C) 2013 American Megatrends, Inc.		

### BIOS Menu 1: Main

The System Overview field has two user configurable fields:

#### → System Date [xx/xx/xx]

Use the **System Date** option to set the system date. Manually enter the day, month and year.

## NANO-BT EPIC SBC

### → System Time [xx:xx:xx]

Use the **System Time** option to set the system time. Manually enter the hours, minutes and seconds.

## 5.3 Advanced

Use the **Advanced** menu (**BIOS Menu 2**) to configure the CPU and peripheral devices through the following sub-menus:



### WARNING!

Setting the wrong values in the sections below may cause the system to malfunction. Make sure that the settings made are compatible with the hardware.

```

Aptio Setup Utility - Copyright (C) 2013 American Megatrends, Inc.
Main  Advanced  Chipset  Security  Boot  Save & Exit

> ACPI Settings
> F81866 Super IO Configuration
> iWDD H/W Monitor
> RTC Wake Settings
> Serial Port Console Redirection
> iEi Feature
> CPU Configuration
> IDE Configuration
> USB Configuration

System ACPI Parameters
-----
<->: Select Screen
↑ ↓: Select Item
EnterSelect
+ - Change Opt.
F1 General Help
F2 Previous Values
F3 Optimized Defaults
F4 Save & Exit
ESC Exit

Version 2.16.1242. Copyright (C) 2013 American Megatrends, Inc.
  
```

### BIOS Menu 2: Advanced

### 5.3.1 ACPI Settings

The **ACPI Settings** menu (**BIOS Menu 3**) configures the Advanced Configuration and Power Interface (ACPI) options.

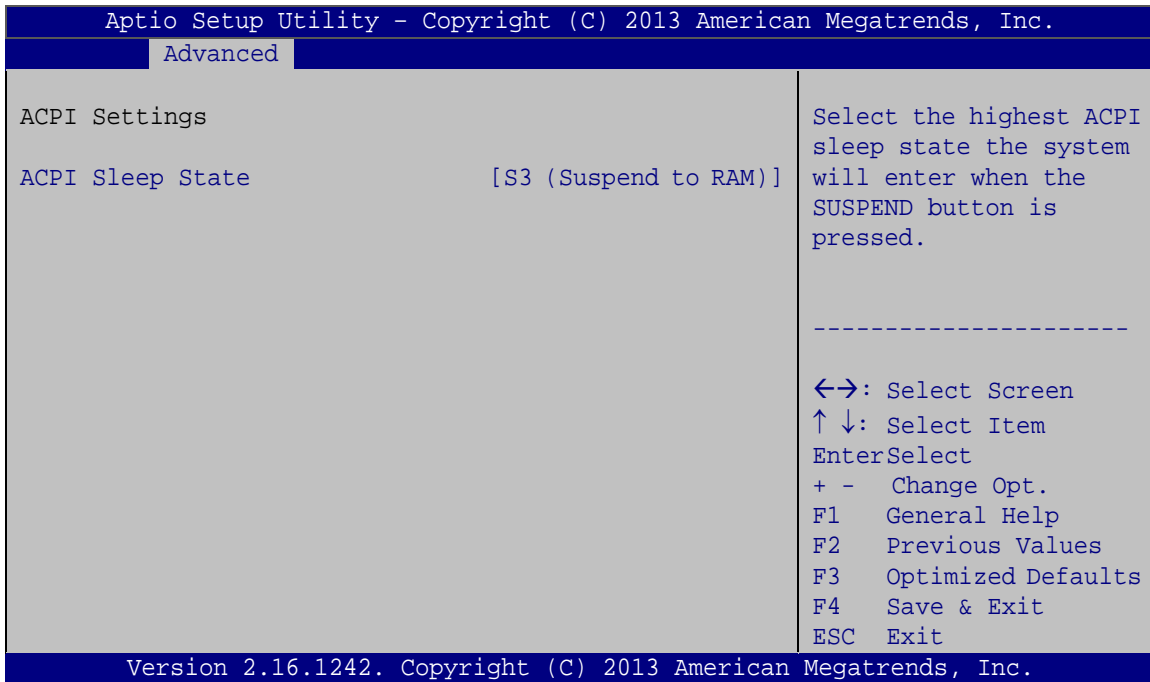

#### **BIOS Menu 3: ACPI Configuration**

##### → **ACPI Sleep State [S3 (Suspend to RAM)]**

Use the **ACPI Sleep State** option to specify the sleep state the system enters when it is not being used.

- **S3 (Suspend to DEFAULT RAM)** The caches are flushed and the CPU is powered off. Power to the RAM is maintained. The computer returns slower to a working state, but more power is saved.

## NANO-BT EPIC SBC

### 5.3.2 F81866 Super IO Configuration

Use the **F81866 Super IO Configuration** menu (**BIOS Menu 4**) to set or change the configurations for the serial ports.

```

Aptio Setup Utility - Copyright (C) 2013 American Megatrends, Inc.
  Advanced
F81866 Super IO Configuration                               Set Parameters of Serial
                                                           Port 1 (COMA)
F81866 Super IO Chip                                     F81866
> Serial Port 1 Configuration
> Serial Port 2 Configuration
> Serial Port 3 Configuration
> Serial Port 4 Configuration
                                                           -----
                                                           <->: Select Screen
                                                           ↑ ↓: Select Item
                                                           EnterSelect
                                                           + - Change Opt.
                                                           F1  General Help
                                                           F2  Previous Values
                                                           F3  Optimized Defaults
                                                           F4  Save & Exit
                                                           ESC Exit
Version 2.16.1242. Copyright (C) 2013 American Megatrends, Inc.
    
```

**BIOS Menu 4: F81866 Super IO Configuration**

#### 5.3.2.1 Serial Port n Configuration

Use the **Serial Port n Configuration** menu (**BIOS Menu 5**) to configure the serial port n.

```

Aptio Setup Utility - Copyright (C) 2013 American Megatrends, Inc.
  Advanced
Serial Port n Configuration                               Enable or Disable Serial
                                                           Port (COM)
Serial Port                                             [Enabled]
Device Settings                                         IO=3F8h;IRQ=4
Change Settings                                         [Auto]
                                                           -----
                                                           <->: Select Screen
                                                           ↑ ↓: Select Item
                                                           EnterSelect
                                                           = - Change Opt.
                                                           F1  General Help
                                                           F2  Previous Values
                                                           F3  Optimized Defaults
                                                           F4  Save & Exit
                                                           ESC Exit
Version 2.16.1242. Copyright (C) 2013 American Megatrends, Inc.
    
```

**BIOS Menu 5: Serial Port n Configuration Menu**



### 5.3.2.1.1 Serial Port 1 Configuration

#### → Serial Port [Enabled]

Use the **Serial Port** option to enable or disable the serial port.

- **Disabled**                      Disable the serial port
- **Enabled**      **DEFAULT**      Enable the serial port

#### → Change Settings [Auto]

Use the **Change Settings** option to change the serial port IO port address and interrupt address.

- **Auto**              **DEFAULT**      The serial port IO port address and interrupt address are automatically detected.
- **IO=3F8h;**  
**IRQ=4**                      Serial Port I/O port address is 3F8h and the interrupt address is IRQ4
- **IO=3F8h;**  
**IRQ=3, 4**                      Serial Port I/O port address is 3F8h and the interrupt address is IRQ3, 4
- **IO=2F8h;**  
**IRQ=3, 4**                      Serial Port I/O port address is 2F8h and the interrupt address is IRQ3, 4
- **IO=3E8h;**  
**IRQ=3, 4**                      Serial Port I/O port address is 3E8h and the interrupt address is IRQ3, 4
- **IO=2E8h;**  
**IRQ=3, 4**                      Serial Port I/O port address is 2E8h and the interrupt address is IRQ3, 4

## NANO-BT EPIC SBC

### 5.3.2.1.2 Serial Port 2 Configuration

#### → Serial Port [Enabled]

Use the **Serial Port** option to enable or disable the serial port.

- **Disabled**                      Disable the serial port
- **Enabled**      **DEFAULT**      Enable the serial port

#### → Change Settings [Auto]

Use the **Change Settings** option to change the serial port IO port address and interrupt address.

- **Auto**              **DEFAULT**      The serial port IO port address and interrupt address are automatically detected.
- **IO=2F8h;**  
**IRQ=3**                      Serial Port I/O port address is 2F8h and the interrupt address is IRQ3
- **IO=3F8h;**  
**IRQ=3, 4**                      Serial Port I/O port address is 3F8h and the interrupt address is IRQ3, 4
- **IO=2F8h;**  
**IRQ=3, 4**                      Serial Port I/O port address is 2F8h and the interrupt address is IRQ3, 4
- **IO=3E8h;**  
**IRQ=3, 4**                      Serial Port I/O port address is 3E8h and the interrupt address is IRQ3, 4
- **IO=2E8h;**  
**IRQ=3, 4**                      Serial Port I/O port address is 2E8h and the interrupt address is IRQ3, 4

### 5.3.2.1.3 Serial Port 3 Configuration

→ **Serial Port [Enabled]**

Use the **Serial Port** option to enable or disable the serial port.

- **Disabled**                      Disable the serial port
- **Enabled      DEFAULT**      Enable the serial port

→ **Change Settings [Auto]**

Use the **Change Settings** option to change the serial port IO port address and interrupt address.

- **Auto              DEFAULT**      The serial port IO port address and interrupt address are automatically detected.
- **IO=3E8h;  
IRQ=10**                      Serial Port I/O port address is 3E8h and the interrupt address is IRQ10
- **IO=3F8h;  
IRQ=10, 11**                      Serial Port I/O port address is 3F8h and the interrupt address is IRQ10, 11
- **IO=2F8h;  
IRQ=10, 11**                      Serial Port I/O port address is 2F8h and the interrupt address is IRQ10, 11
- **IO=3E8h;  
IRQ=10, 11**                      Serial Port I/O port address is 3E8h and the interrupt address is IRQ10, 11
- **IO=2E8h;  
IRQ=10, 11**                      Serial Port I/O port address is 2E8h and the interrupt address is IRQ10, 11
- **IO=2E0h;  
IRQ=10, 11**                      Serial Port I/O port address is 2E0h and the interrupt address is IRQ10, 11

## NANO-BT EPIC SBC

### 5.3.2.1.4 Serial Port 4 Configuration

#### → Serial Port [Enabled]

Use the **Serial Port** option to enable or disable the serial port.

- **Disabled**                      Disable the serial port
- **Enabled**      **DEFAULT**      Enable the serial port

#### → Change Settings [Auto]

Use the **Change Settings** option to change the serial port IO port address and interrupt address.

- **Auto**              **DEFAULT**      The serial port IO port address and interrupt address are automatically detected.
- **IO=2E8h;**  
**IRQ=10**                      Serial Port I/O port address is 2E8h and the interrupt address is IRQ10
- **IO=3F8h;**  
**IRQ=10, 11**                      Serial Port I/O port address is 3F8h and the interrupt address is IRQ10, 11
- **IO=2F8h;**  
**IRQ=10, 11**                      Serial Port I/O port address is 2F8h and the interrupt address is IRQ10, 11
- **IO=3E8h;**  
**IRQ=10, 11**                      Serial Port I/O port address is 3E8h and the interrupt address is IRQ10, 11
- **IO=2E8h;**  
**IRQ=10, 11**                      Serial Port I/O port address is 2E8h and the interrupt address is IRQ10, 11
- **IO=2E0h;**  
**IRQ=10, 11**                      Serial Port I/O port address is 2E0h and the interrupt address is IRQ10, 11

### 5.3.3 iWDD H/W Monitor

The **iWDD H/W Monitor** menu (**BIOS Menu 6**) contains the fan configuration submenus and displays operating temperature, fan speeds and system voltages.

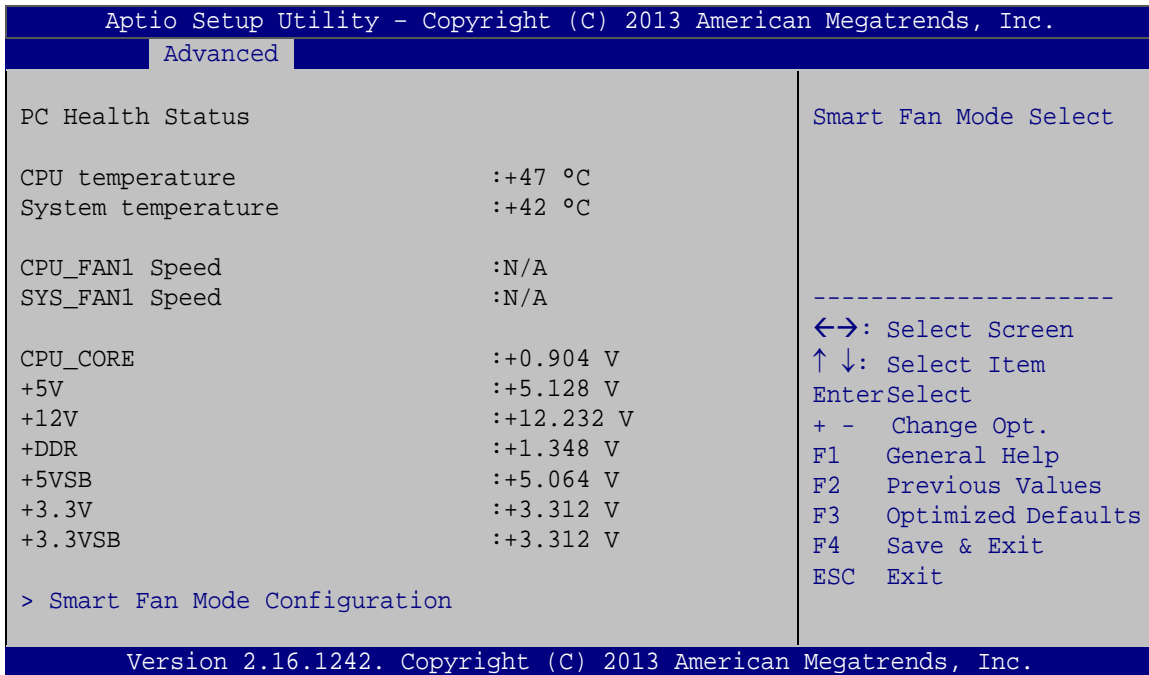

#### BIOS Menu 6: iWDD H/W Monitor

##### ➔ PC Health Status

The following system parameters and values are shown. The system parameters that are monitored are:

- System Temperatures:
  - CPU Temperature
  - System Temperature
- Fan Speeds:
  - CPU Fan Speed
  - System Fan Speed
- Voltages:
  - CPU\_CORE
  - +5V
  - +12V



## NANO-BT EPIC SBC

- +DDR
- +5VSB
- +3.3V
- +3.3VSB

### 5.3.3.1 Smart Fan Mode Configuration

Use the **Smart Fan Mode Configuration** submenu (**BIOS Menu 7**) to configure smart fan temperature and speed settings.

```

Aptio Setup Utility - Copyright (C) 2013 American Megatrends, Inc.
Advanced
Smart Fan Mode Configuration
CPU_FAN1 Smart Fan Control      [Manual Mode]
Manual Mode                      70
SYS_FAN1 Smart Fan Control      [Auto Mode]
Auto mode fan start temperature  50
Auto mode fan off temperature   40
Auto mode fan start PWM         30
Auto mode fan slope PWM         1

Smart Fan Mode Select
-----
<=>: Select Screen
↑ ↓: Select Item
EnterSelect
+ - Change Opt.
F1  General Help
F2  Previous Values
F3  Optimized Defaults
F4  Save & Exit
ESC Exit

Version 2.16.1242. Copyright (C) 2013 American Megatrends, Inc.
    
```

#### BIOS Menu 7: Smart Fan Mode Configuration

##### → CPU\_FAN1 Smart Fan Control [Manual Mode]

Use the **CPU\_FAN1 Smart Fan Control** option to configure the CPU Smart Fan.

- **Manual Mode**    **DEFAULT**    The fan spins at the speed set in Manual Mode settings.

##### → Manual Mode

Use the + or – key to change the **Manual Mode** value. Enter a decimal number between 1 and 100.

→ **SYS\_FAN1 Smart Fan Control [Auto Mode]**

Use the **SYS\_FAN1 Smart Fan Control** option to configure the System Smart Fan.

- **Manual Mode**                      The fan spins at the speed set in Manual Mode settings.
- **Auto Mode**                      **DEFAULT**      The fan adjusts its speed using Auto Mode settings.

→ **Auto mode fan start/off temperature**

Use the + or – key to change the **Auto mode fan start/off temperature** value. Enter a decimal number between 1 and 100.

→ **Auto mode fan start PWM**

Use the + or – key to change the **Auto mode fan start PWM** value. Enter a decimal number between 1 and 100.

→ **Auto mode fan slope PWM**

Use the + or – key to change the **Auto mode fan slope PWM** value. Enter a decimal number between 1 and 64.

## NANO-BT EPIC SBC

### 5.3.4 RTC Wake Settings

The **RTC Wake Settings** menu (**BIOS Menu 8**) configures RTC wake event. The RTC wake function is supported in ACPI (S3/S4/S5) and APM soft off modes.

```

Aptio Setup Utility - Copyright (C) 2013 American Megatrends, Inc.
  Advanced
Wake System with Fixed Time      [Disabled]
                                     Enables or Disables
                                     system wake on alarm
                                     event. When enabled,
                                     system will wake on the
                                     date: hr: min: sec
                                     specified.
-----
<=>: Select Screen
↑ ↓: Select Item
EnterSelect
+ -  Change Opt.
F1   General Help
F2   Previous Values
F3   Optimized Defaults
F4   Save & Exit
ESC  Exit
Version 2.16.1242. Copyright (C) 2013 American Megatrends, Inc.
    
```

#### BIOS Menu 8: RTC Wake Settings

##### → Wake System with Fixed Time [Disabled]

Use the **Wake System with Fixed Time** option to specify the time the system should be roused from a suspended state.

- **Disabled**      **DEFAULT**      The real time clock (RTC) cannot generate a wake event

➔ **Enabled**

If selected, the following appears with values that can be selected:

\*Wake up every day

\*Wake up date

\*Wake up hour

\*Wake up minute

\*Wake up second

After setting the alarm, the computer turns itself on from a suspend state when the alarm goes off.

### 5.3.5 Serial Port Console Redirection

The **Serial Port Console Redirection** menu (**BIOS Menu 9**) allows the console redirection options to be configured. Console redirection allows users to maintain a system remotely by re-directing keyboard input and text output through the serial port.

```

Aptio Setup Utility - Copyright (C) 2013 American Megatrends, Inc.
  Advanced
COM1
  Console Redirection      [Disabled]      Console Redirection
  > Console Redirection Settings      Enable or Disable

COM2
  Console Redirection      [Disabled]
  > Console Redirection Settings

COM3
  Console Redirection      [Disabled]
  > Console Redirection Settings

COM4
  Console Redirection      [Disabled]
  > Console Redirection Settings

COM5
  Console Redirection      Port Is Disabled

-----
<->: Select Screen
↑ ↓: Select Item
Enter>Select
+/-: Change Opt.
F1  General Help
F2  Previous Values
F3  Optimized Defaults
F4  Save & Exit
ESC Exit

Version 2.16.1242. Copyright (C) 2013 American Megatrends, Inc.
    
```

**BIOS Menu 9: Serial Port Console Redirection**

## NANO-BT EPIC SBC

### → Console Redirection [Disabled]

Use **Console Redirection** option to enable or disable the console redirection function.

- **Disabled**      **DEFAULT**      Disabled the console redirection function
- **Enabled**                      Enabled the console redirection function

The following options are available in the **Console Redirection Settings** submenu when the Console Redirection option is enabled.

### → Terminal Type [ANSI]

Use the **Terminal Type** option to specify the remote terminal type.

- **VT100**                      The target terminal type is VT100
- **VT100+**                      The target terminal type is VT100+
- **VT-UTF8**                      The target terminal type is VT-UTF8
- **ANSI**              **DEFAULT**      The target terminal type is ANSI

### → Bits per second [115200]

Use the **Bits per second** option to specify the serial port transmission speed. The speed must match the other side. Long or noisy lines may require lower speeds.

- **9600**                      Sets the serial port transmission speed at 9600.
- **19200**                      Sets the serial port transmission speed at 19200.
- **38400**                      Sets the serial port transmission speed at 38400.
- **57600**                      Sets the serial port transmission speed at 57600.
- **115200**              **DEFAULT**      Sets the serial port transmission speed at 115200.



**→ Data Bits [8]**

Use the **Data Bits** option to specify the number of data bits.

- 7** Sets the data bits at 7.
- 8** **DEFAULT** Sets the data bits at 8.

**→ Parity [None]**

Use the **Parity** option to specify the parity bit that can be sent with the data bits for detecting the transmission errors.

- None** **DEFAULT** No parity bit is sent with the data bits.
- Even** The parity bit is 0 if the number of ones in the data bits is even.
- Odd** The parity bit is 0 if the number of ones in the data bits is odd.
- Mark** The parity bit is always 1. This option does not provide error detection.
- Space** The parity bit is always 0. This option does not provide error detection.

**→ Stop Bits [1]**

Use the **Stop Bits** option to specify the number of stop bits used to indicate the end of a serial data packet. Communication with slow devices may require more than 1 stop bit.

- 1** **DEFAULT** Sets the number of stop bits at 1.
- 2** Sets the number of stop bits at 2.

## NANO-BT EPIC SBC

### 5.3.6 IEI Feature

Use the **IEI Feature** menu (**BIOS Menu 10**) to configure One Key Recovery function.

```

Aptio Setup Utility - Copyright (C) 2013 American Megatrends, Inc.
  Advanced
iEi Feature
Auto Recovery Function          [Disabled]
                                Auto Recovery Function
                                Reboot and recover
                                system automatically
                                within 10 min, when OS
                                crashes. Please install
                                Auto Recovery API
                                service before enabling
                                this funciton.
                                -----
                                ←→: Select Screen
                                ↑ ↓: Select Item
                                EnterSelect
                                + - Change Opt.
                                F1  General Help
                                F2  Previous Values
                                F3  Optimized Defaults
                                F4  Save
                                ESC Exit
Version 2.16.1242. Copyright (C) 2013 American Megatrends, Inc.

```

#### BIOS Menu 10: IEI Feature

##### ➔ Auto Recovery Function [Disabled]

Use the **Auto Recovery Function** BIOS option to enable or disable the auto recovery function of the IEI One Key Recovery.

- ➔ **Disabled**     **DEFAULT**     Auto recovery function disabled
- ➔ **Enabled**     Auto recovery function enabled

### 5.3.7 CPU Configuration

Use the **CPU Configuration** BIOS menu (**BIOS Menu 11**) to view detailed CPU specifications and configure the CPU.

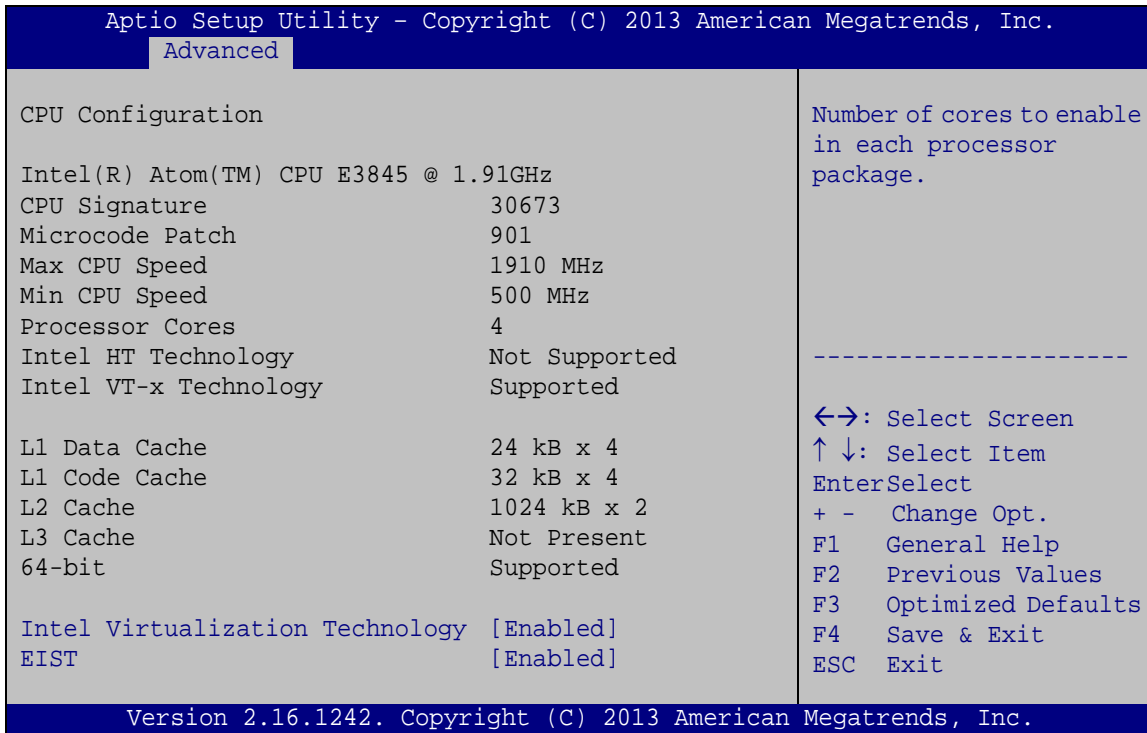

#### BIOS Menu 11: CPU Configuration

The CPU Configuration menu (**BIOS Menu 11**) lists the following CPU details:

- CPU Signature: Lists the CPU signature value.
- Microcode Patch: Lists the microcode patch being used.
- Max CPU Speed: Lists the maximum CPU processing speed.
- Min CPU Speed: Lists the minimum CPU processing speed.
- Processor Cores: Lists the number of the processor core
- Intel HT Technology: Indicates if Intel HT Technology is supported by the CPU.
- Intel VT-x Technology: Indicates if Intel VT-x Technology is supported by the CPU.
- L1 Data Cache: Lists the amount of data storage space on the L1 cache.
- L1 Code Cache: Lists the amount of code storage space on the L1 cache.

## NANO-BT EPIC SBC

- L2 Cache: Lists the amount of storage space on the L2 cache.
- L3 Cache: Lists the amount of storage space on the L3 cache.

### → Intel Virtualization Technology [Enabled]

Use the **Intel Virtualization Technology** option to enable or disable virtualization on the system. When combined with third party software, Intel® Virtualization technology allows several OSs to run on the same system at the same time.

- |            |         |   |
|------------|---------|---|
| → Disabled |         | Disables Intel Virtualization Technology. |
| → Enabled  | DEFAULT | Enables Intel Virtualization Technology.  |

### → EIST [Enabled]

Use the **EIST** option to enable or disable Enhanced Intel SpeedStep® Technology (EIST).

- |            |         |  |
|------------|---------|--|
| → Disabled |         | Disables Enhanced Intel SpeedStep® Technology. |
| → Enabled  | DEFAULT | Enables Enhanced Intel SpeedStep® Technology.  |

### 5.3.8 IDE Configuration

Use the **IDE Configuration** menu (**BIOS Menu 12**) to change and/or set the configuration of the SATA devices installed in the system.

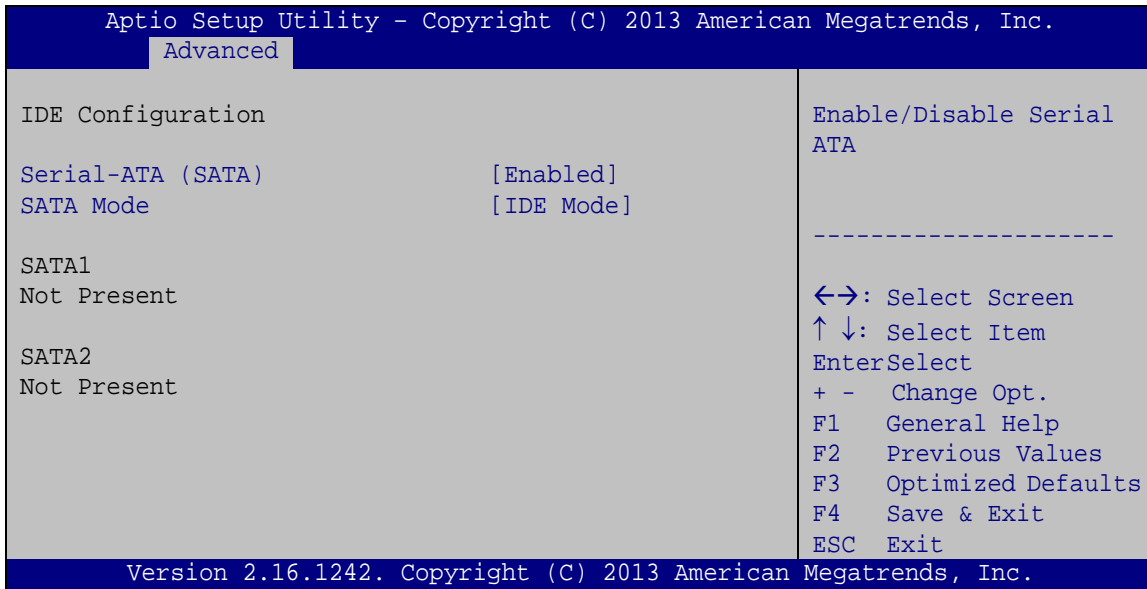

#### BIOS Menu 12: IDE Configuration

##### → Serial-ATA (SATA) [Enabled]

Use the **Serial-ATA (SATA)** option to enable or disable the serial ATA controller.

- **Enabled**      **DEFAULT**      Enables the on-board SATA controller.
- **Disabled**                      Disables the on-board SATA controller.

##### → SATA Mode Selection [IDE Mode]

Use the **SATA Mode Selection** option to configure SATA devices as normal IDE devices.

- **IDE Mode**      **DEFAULT**      Configures SATA devices as normal IDE device.
- **AHCI Mode**                      Configures SATA devices as AHCI device.



## NANO-BT EPIC SBC

### 5.3.9 USB Configuration

Use the **USB Configuration** menu (**BIOS Menu 13**) to read USB configuration information and configure the USB settings.

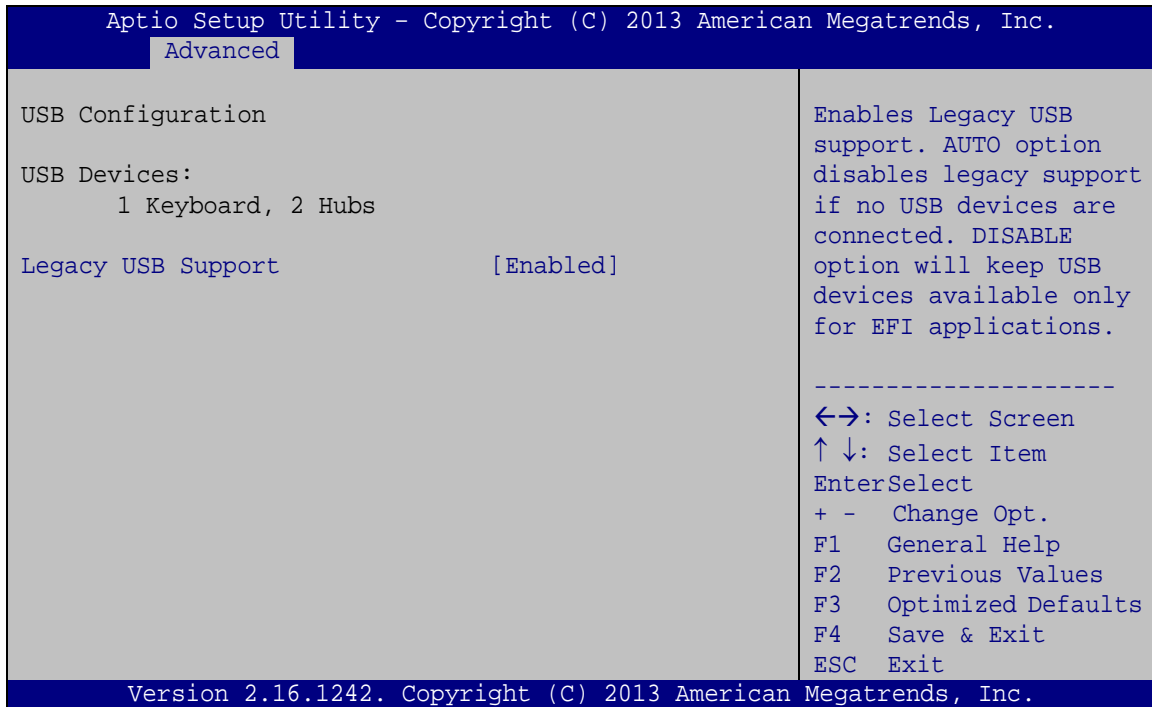

#### BIOS Menu 13: USB Configuration

##### ➔ USB Devices

The **USB Devices Enabled** field lists the USB devices that are enabled on the system

##### ➔ Legacy USB Support [Enabled]

Use the **Legacy USB Support** BIOS option to enable USB mouse and USB keyboard support. Normally if this option is not enabled, any attached USB mouse or USB keyboard does not become available until a USB compatible operating system is fully booted with all USB drivers loaded. When this option is enabled, any attached USB mouse or USB keyboard can control the system even when there is no USB driver loaded onto the system.

➔ **Enabled**      **DEFAULT**      Legacy USB support enabled

- ➔ **Disabled** Legacy USB support disabled
- ➔ **Auto** Legacy USB support disabled if no USB devices are connected

## 5.4 Chipset

Use the **Chipset** menu (**BIOS Menu 14**) to access the North Bridge and South Bridge subsystem configuration menus.



### **WARNING!**

Setting the wrong values for the Chipset BIOS selections in the Chipset BIOS menu may cause the system to malfunction.

```

Aptio Setup Utility - Copyright (C) 2013 American Megatrends, Inc.
Main   Advanced  Chipset  Security  Boot   Save & Exit
-----
> North Bridge
> South Bridge

North Bridge Parameters.
-----
<=>: Select Screen
↑ ↓: Select Item
Enter Select
+ - Change Opt.
F1  General Help
F2  Previous Values
F3  Optimized Defaults
F4  Save & Exit
ESC Exit

Version 2.16.1242. Copyright (C) 2013 American Megatrends, Inc.
    
```

**BIOS Menu 14: Chipset**

## NANO-BT EPIC SBC

### 5.4.1 North Bridge

Use the **North Bridge** menu (**BIOS Menu 15**) to configure the north bridge parameters.

```

Aptio Setup Utility - Copyright (C) 2013 American Megatrends, Inc.
  Chipset
> Intel IGD Configuration          Configure Intel IGD
Memory Information                Settings.
Total Memory                      2048 MB (LPDDR3)
DIMM1                             2048 MB (LPDDR3)
-----
<=>: Select Screen
↑↓: Select Item
EnterSelect
+ - Change Opt.
F1  General Help
F2  Previous Values
F3  Optimized Defaults
F4  Save & Exit
ESC Exit
Version 2.16.1242. Copyright (C) 2013 American Megatrends, Inc.

```

#### BIOS Menu 15: North Bridge

#### 5.4.1.1 Intel IGD Configuration

Use the **Intel IGD Configuration** submenu (**BIOS Menu 16**) to configure the graphics settings.

```

Aptio Setup Utility - Copyright (C) 2013 American Megatrends, Inc.
  Chipset
Intel IGD Configuration          Select which of IGD/PCI
Primary Display                  Graphics device should
DVTM Pre-Allocated              be Primary Display.
DVTM Total Gfx Mem
-----
Primary IGFX Boot Display       <=>: Select Screen
On board LVDS                   ↑↓: Select Item
Backlight Control Mode          EnterSelect
Backlight Control Type          + - Change Opt.
Backlight Control Voltage Level F1  General Help
                               F2  Previous Values
                               F3  Optimized Defaults
                               F4  Save & Exit
                               ESC Exit
Version 2.16.1242. Copyright (C) 2013 American Megatrends, Inc.

```

#### BIOS Menu 16: Intel IGD Configuration

**→ Primary Display [Auto]**

Use the **Primary Display** option to select the display device used by the system when it boots. Configuration options are listed below.

- Auto
- IGD                   **DEFAULT**
- PCI

**→ DVMT Pre-Allocated [256M]**

Use the **DVMT Pre-Allocated** option to specify the amount of system memory that can be used by the internal graphics device.

- 64M**                                   64 MB of memory used by internal graphics device
- 128M**                               128 MB of memory used by internal graphics device
- 256M**                               **DEFAULT**   256 MB of memory used by internal graphics device
- 512M**                               512 MB of memory used by internal graphics device

**→ DVMT Total Gfx Mem [Max]**

Use the **DVMT Total Gfx Mem** option to specify the maximum amount of memory that can be allocated as graphics memory. Configuration options are listed below.

- 128MB
- 256MB
- Max                   **DEFAULT**

**→ Primary IGFX Boot Display [VBIOS Default]**

Use the **Primary IGFX Boot Display** option to select the display device used by the system when it boots. Configuration options are listed below.

- VBIOS Default       **DEFAULT**

## NANO-BT EPIC SBC

- CRT
- HDMI
- LVDS

### → On board LVDS [Enabled]

Use the **On board LVDS** option to enable or disable the LVDS connector on the board.

- **Disabled** Disable the on-board LVDS connector.
- **Enabled** **DEFAULT** Enables the on-board LVDS connector.

### → Backlight Control Mode [CCFL]

Use the **Backlight Control Mode** option to specify the backlight control mode. Configuration options are listed below.

- LED
- CCFL **DEFAULT**

### → Backlight Control Type [PWM]

Use the **Backlight Control Type** option to specify the backlight control type. Configuration options are listed below.

- PWM **DEFAULT**
- DC

### → Backlight Control Voltage Level [3.3V]

Use the **Backlight Control Voltage Level** option to specify the voltage of the power supplied to the LCD panel. Configuration options are listed below.

- 3.3V **DEFAULT**
- 5.0V



### 5.4.2 South Bridge

Use the **South Bridge** menu (**BIOS Menu 17**) to configure the south bridge parameters.

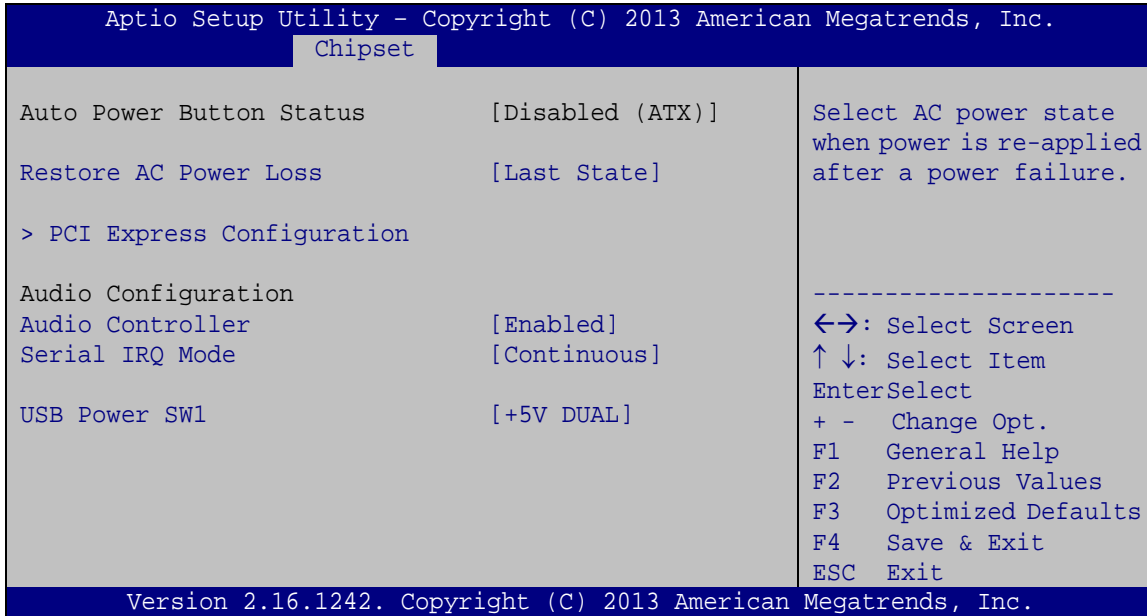

#### BIOS Menu 17: South Bridge

##### → Restore on AC Power Loss [Last State]

Use the **Restore on AC Power Loss** BIOS option to specify what state the system returns to if there is a sudden loss of power to the system.

- **Power Off**                      The system remains turned off
- **Power On**                        The system turns on
- **Last State**    **DEFAULT**      The system returns to its previous state. If it was on, it turns itself on. If it was off, it remains off.

##### → Audio Controller [Enabled]

Use the **Audio Controller** BIOS option to enable or disable the High Definition Audio controller.

- **Disabled**                            The High Definition Audio controller is disabled.

## NANO-BT EPIC SBC

➔ **Enabled**      **DEFAULT**      The High Definition Audio controller is enabled.

### ➔ **Serial IRQ Mode [Continuous]**

Use the **Serial IRQ Mode** option to configure serial IRQ mode for serial interrupts. Configuration options are listed below:

- Quiet
- Continuous      **DEFAULT**

### ➔ **USB Power SW1 [+5V DUAL]**

Use the **USB Power SW1** BIOS option to configure the USB power source for the USB connectors – CN6, CN7 and USB1.

➔ **+5V**      Set the USB power source to +5V

➔ **+5V DUAL**      **DEFAULT**      Set the USB power source to +5V dual

## 5.4.2.1 PCI Express Configuration

Use the **PCI Express Configuration** submenu (**BIOS Menu 18**) to configure the PCI Express slots.

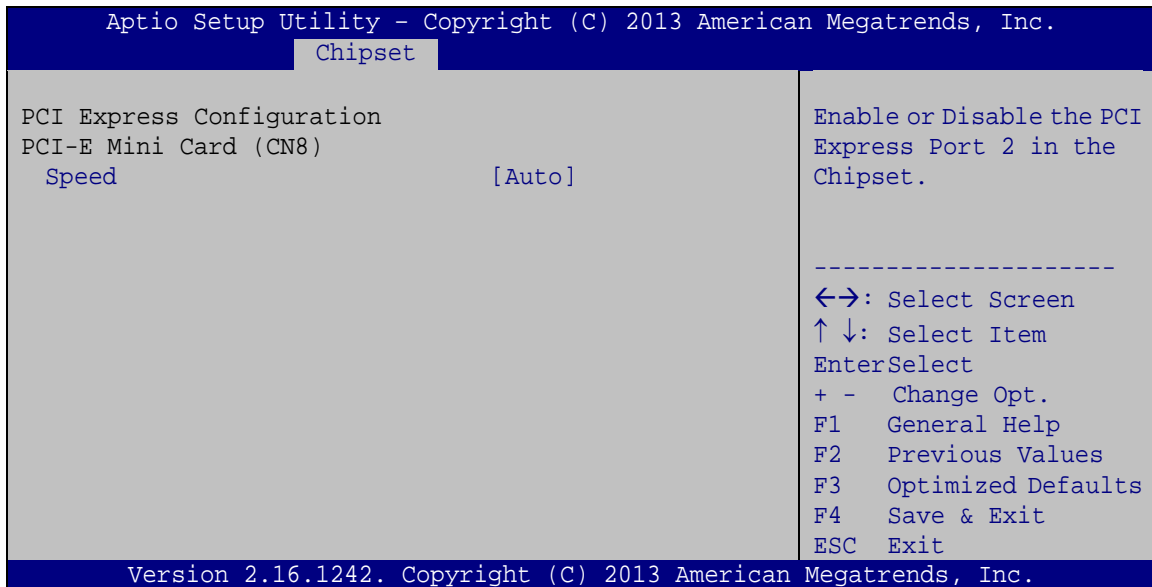

**BIOS Menu 18: PCI Express Configuration**

➔ **Speed [Auto]**

Use the **Speed** option to configure the PCIe Mini card slot (CN8) speed.

- Auto                   **DEFAULT**
- Gen 2
- Gen 1

## 5.5 Security

Use the **Security** menu (**BIOS Menu 19**) to set system and user passwords.

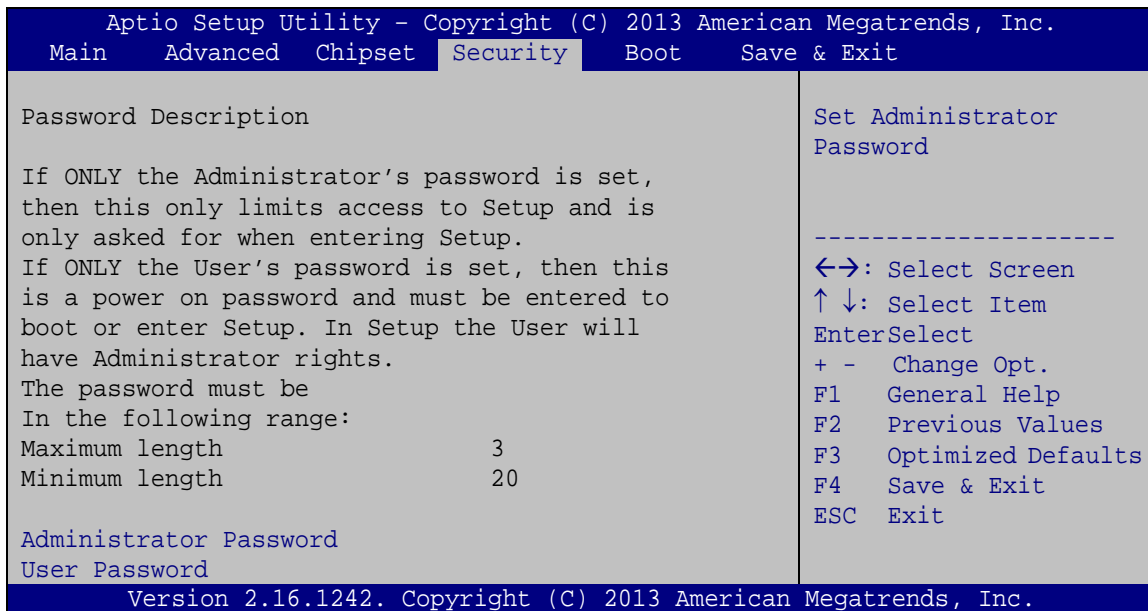

### BIOS Menu 19: Security

➔ **Administrator Password**

Use the **Administrator Password** to set or change a administrator password.

➔ **User Password**

Use the **User Password** to set or change a user password.

## NANO-BT EPIC SBC

### 5.6 Boot

Use the **Boot** menu (**BIOS Menu 20**) to configure system boot options.

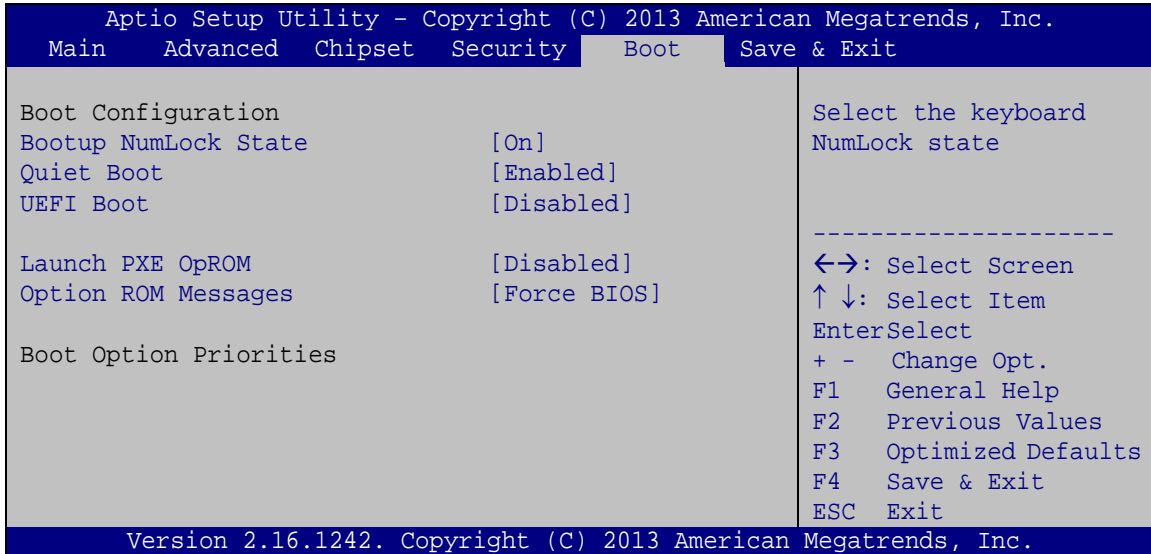

#### BIOS Menu 20: Boot

##### → Bootup NumLock State [On]

Use the **Bootup NumLock State** BIOS option to specify if the number lock setting must be modified during boot up.

- **On**                      **DEFAULT**                      Allows the Number Lock on the keyboard to be enabled automatically when the computer system boots up. This allows the immediate use of the 10-key numeric keypad located on the right side of the keyboard. To confirm this, the Number Lock LED light on the keyboard is lit.
- **Off**    Does not enable the keyboard Number Lock automatically. To use the 10-keys on the keyboard, press the Number Lock key located on the upper left-hand corner of the 10-key pad. The Number Lock LED on the keyboard lights up when the Number Lock is engaged.

→ **Quiet Boot [Enabled]**

Use the **Quiet Boot** BIOS option to select the screen display when the system boots.

- **Disabled** Normal POST messages displayed
- **Enabled** **DEFAULT** OEM Logo displayed instead of POST messages

→ **UEFI Boot [Disabled]**

Use the **UEFI Boot** option to enable or disable to boot from a UEFI device.

- **Enabled** Enable to boot from a UEFI device.
- **Disabled** **DEFAULT** Disable to boot from a UEFI device.

→ **Launch PXE OpROM [Disabled]**

Use the **Launch PXE OpROM** option to enable or disable boot option for legacy network devices.

- **Disabled** **DEFAULT** Ignore all PXE Option ROMs
- **Enabled** Load PXE Option ROMs

→ **Option ROM Messages [Force BIOS]**

Use the **Option ROM Messages** option to set the Option ROM display mode.

- **Force BIOS** **DEFAULT** Sets display mode to force BIOS.
- **Keep Current** Sets display mode to current.



## NANO-BT EPIC SBC

### 5.7 Save & Exit

Use the **Save & Exit** menu (**BIOS Menu 21**) to load default BIOS values, optimal failsafe values and to save configuration changes.

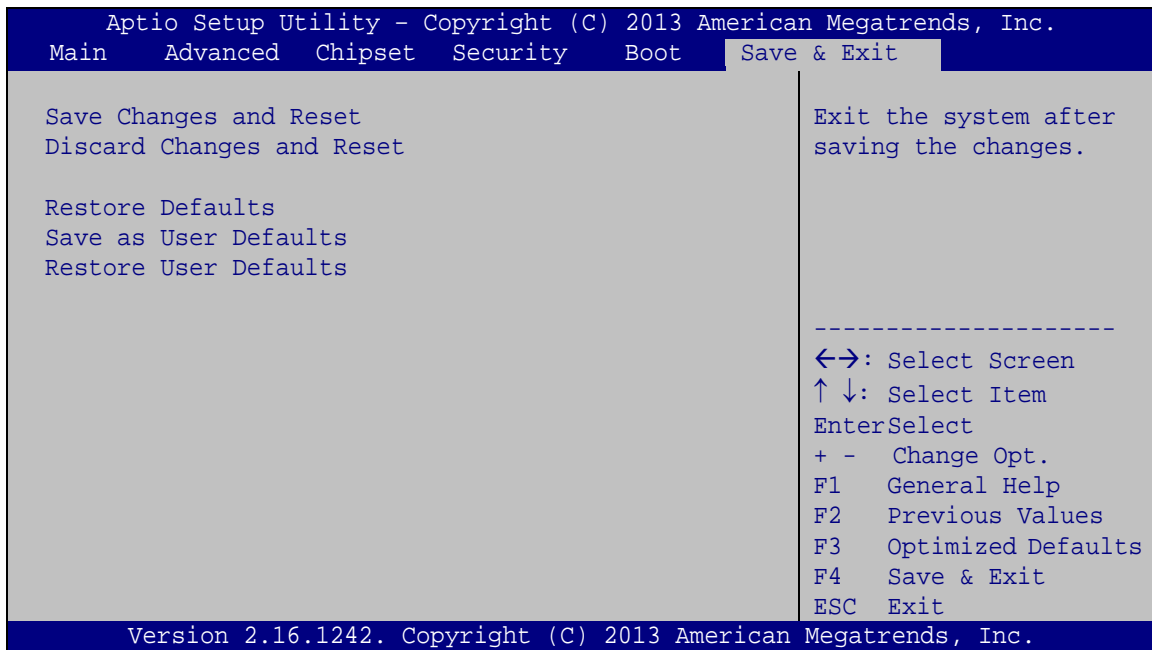

#### BIOS Menu 21: Save & Exit

##### → Save Changes and Reset

Use the **Save Changes and Reset** option to save the changes made to the BIOS options and reset the system.

##### → Discard Changes and Reset

Use the **Discard Changes and Reset** option to exit the system without saving the changes made to the BIOS configuration setup program.

##### → Restore Defaults

Use the **Restore Defaults** option to load the optimal default values for each of the parameters on the Setup menus. **F3 key can be used for this operation.**

→ **Save as User Defaults**

Use the **Save as User Defaults** option to save the changes done so far as user defaults.

→ **Restore User Defaults**

Use the **Restore User Defaults** option to restore the user defaults to all the setup options.

Chapter

6

# Software Drivers

---

## 6.1 Available Drivers

All the drivers for the NANO-BT are available on IEI Resource Download Center (<https://download.ieiworld.com>). Type NANO-BT and press Enter to find all the relevant software, utilities, and documentation.

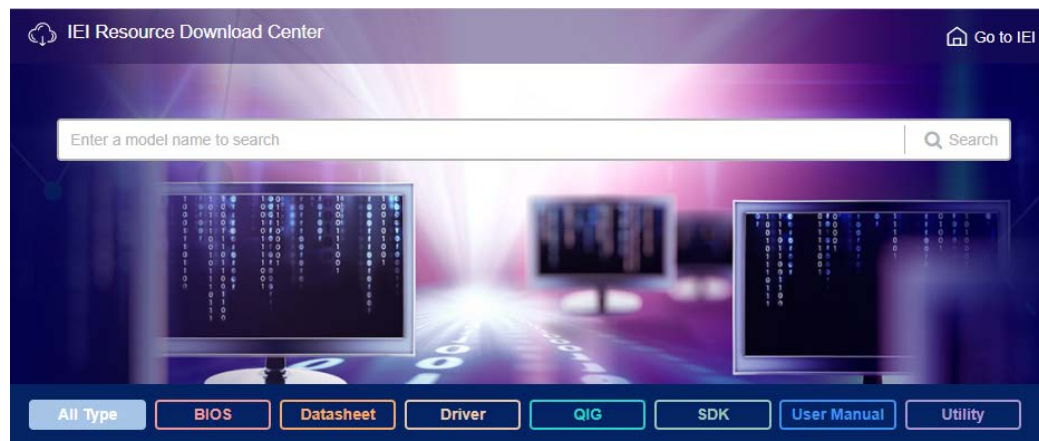

Figure 6-1: IEI Resource Download Center



### NOTE:

The Intel TXE requires that Microsoft's "Kernel-Mode Driver Framework (KMDF) version 1.11 update for Windows 7" is installed first. If the KMDF is not installed, either error 37 or error 28 may appear on the Intel TXE device in Device Manager.

Click the following link to download the KMDF version 1.11 update for Windows 7:

<http://www.microsoft.com/en-us/download/details.aspx?id=38423>

## NANO-BT EPIC SBC

### 6.2 Driver Download

To download drivers from IEI Resource Download Center, follow the steps below.

**Step 1:** Go to <https://download.ieiworld.com>. Type NANO-BT and press Enter.



**Step 2:** All product-related software, utilities, and documentation will be listed. You can choose **Driver** to filter the result.

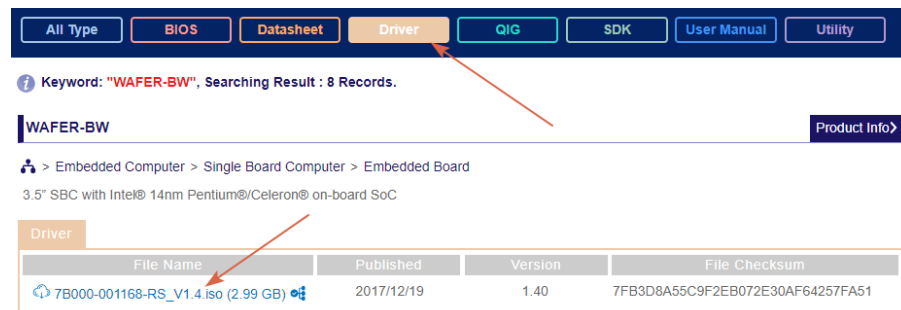

**Step 3:** Click the driver file name on the page and you will be prompted with the following window. You can download the entire ISO file (❶), or click the small arrow to find an individual driver and click the file name to download (❷).

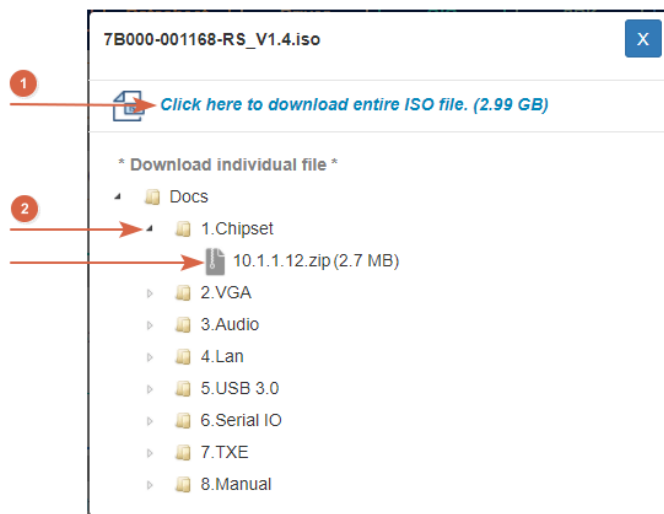



**NOTE:**

To install software from the downloaded ISO image file in Windows 8, 8.1 or 10, double-click the ISO file to mount it as a virtual drive to view its content. On Windows 7 system, an additional tool (such as Virtual CD-ROM Control Panel from Microsoft) is needed to mount the file.

---

Appendix

A

# Regulatory Compliance

---

**DECLARATION OF CONFORMITY**

This equipment has been tested and found to comply with specifications for CE marking. If the user modifies and/or installs other devices in the equipment, the CE conformity declaration may no longer apply.

**FCC WARNING**

This equipment complies with Part 15 of the FCC Rules. Operation is subject to the following two conditions:

- This device may not cause harmful interference, and
- This device must accept any interference received, including interference that may cause undesired operation.

This equipment has been tested and found to comply with the limits for a Class A digital device, pursuant to part 15 of the FCC Rules. These limits are designed to provide reasonable protection against harmful interference when the equipment is operated in a commercial environment. This equipment generates, uses, and can radiate radio frequency energy and, if not installed and used in accordance with the instruction manual, may cause harmful interference to radio communications. Operation of this equipment in a residential area is likely to cause harmful interference in which case the user will be required to correct the interference at his own expense.

Appendix

**B**

# Product Disposal

---

**CAUTION:**

Risk of explosion if battery is replaced by an incorrect type. Only certified engineers should replace the on-board battery.

Dispose of used batteries according to instructions and local regulations.

- Outside the European Union – If you wish to dispose of used electrical and electronic products outside the European Union, please contact your local authority so as to comply with the correct disposal method.
- Within the European Union – The device that produces less waste and is easier to recycle is classified as electronic device in terms of the European Directive 2012/19/EU (WEEE), and must not be disposed of as domestic garbage.

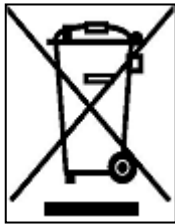

EU-wide legislation, as implemented in each Member State, requires that waste electrical and electronic products carrying the mark (left) must be disposed of separately from normal household waste. This includes monitors and electrical accessories, such as signal cables or power cords. When you need to dispose of your device, please follow the guidance of your local authority, or ask the shop where you purchased the product. The mark on electrical and electronic products only applies to the current European Union Member States.

Please follow the national guidelines for electrical and electronic product disposal.



Appendix

C

# BIOS Options

---

Below is a list of BIOS configuration options in the BIOS chapter.

<input type="checkbox"/>	<b>System Date [xx/xx/xx]</b> .....	<b>76</b>
<input type="checkbox"/>	<b>System Time [xx:xx:xx]</b> .....	<b>77</b>
<input type="checkbox"/>	<b>ACPI Sleep State [S3 (Suspend to RAM)]</b> .....	<b>78</b>
<input type="checkbox"/>	<b>Serial Port [Enabled]</b> .....	<b>80</b>
<input type="checkbox"/>	<b>Change Settings [Auto]</b> .....	<b>80</b>
<input type="checkbox"/>	<b>Serial Port [Enabled]</b> .....	<b>81</b>
<input type="checkbox"/>	<b>Change Settings [Auto]</b> .....	<b>81</b>
<input type="checkbox"/>	<b>Serial Port [Enabled]</b> .....	<b>82</b>
<input type="checkbox"/>	<b>Change Settings [Auto]</b> .....	<b>82</b>
<input type="checkbox"/>	<b>Serial Port [Enabled]</b> .....	<b>83</b>
<input type="checkbox"/>	<b>Change Settings [Auto]</b> .....	<b>83</b>
<input type="checkbox"/>	<b>PC Health Status</b> .....	<b>84</b>
<input type="checkbox"/>	<b>CPU_FAN1 Smart Fan Control [Manual Mode]</b> .....	<b>85</b>
<input type="checkbox"/>	<b>Manual Mode</b> .....	<b>85</b>
<input type="checkbox"/>	<b>SYS_FAN1 Smart Fan Control [Auto Mode]</b> .....	<b>86</b>
<input type="checkbox"/>	<b>Auto mode fan start/off temperature</b> .....	<b>86</b>
<input type="checkbox"/>	<b>Auto mode fan start PWM</b> .....	<b>86</b>
<input type="checkbox"/>	<b>Auto mode fan slope PWM</b> .....	<b>86</b>
<input type="checkbox"/>	<b>Wake System with Fixed Time [Disabled]</b> .....	<b>87</b>
<input type="checkbox"/>	<b>Console Redirection [Disabled]</b> .....	<b>89</b>
<input type="checkbox"/>	<b>Terminal Type [ANSI]</b> .....	<b>89</b>
<input type="checkbox"/>	<b>Bits per second [115200]</b> .....	<b>89</b>
<input type="checkbox"/>	<b>Data Bits [8]</b> .....	<b>90</b>
<input type="checkbox"/>	<b>Parity [None]</b> .....	<b>90</b>
<input type="checkbox"/>	<b>Stop Bits [1]</b> .....	<b>90</b>
<input type="checkbox"/>	<b>Auto Recovery Function [Disabled]</b> .....	<b>91</b>
<input type="checkbox"/>	<b>Intel Virtualization Technology [Enabled]</b> .....	<b>93</b>
<input type="checkbox"/>	<b>EIST [Enabled]</b> .....	<b>93</b>
<input type="checkbox"/>	<b>Serial-ATA (SATA) [Enabled]</b> .....	<b>94</b>
<input type="checkbox"/>	<b>SATA Mode Selection [IDE Mode]</b> .....	<b>94</b>
<input type="checkbox"/>	<b>USB Devices</b> .....	<b>95</b>
<input type="checkbox"/>	<b>Legacy USB Support [Enabled]</b> .....	<b>95</b>
<input type="checkbox"/>	<b>Primary Display [Auto]</b> .....	<b>98</b>

## NANO-BT EPIC SBC

<input type="checkbox"/>	DVMT Pre-Allocated [256M] .....	98
<input type="checkbox"/>	DVMT Total Gfx Mem [Max].....	98
<input type="checkbox"/>	Primary IGFX Boot Display [VBIOS Default] .....	98
<input type="checkbox"/>	On board LVDS [Enabled] .....	99
<input type="checkbox"/>	Backlight Control Mode [CCFL].....	99
<input type="checkbox"/>	Backlight Control Type [PWM] .....	99
<input type="checkbox"/>	Backlight Control Voltage Level [3.3V].....	99
<input type="checkbox"/>	Restore on AC Power Loss [Last State].....	100
<input type="checkbox"/>	Audio Controller [Enabled] .....	100
<input type="checkbox"/>	Serial IRQ Mode [Continuous].....	101
<input type="checkbox"/>	USB Power SW1 [+5V DUAL].....	101
<input type="checkbox"/>	Speed [Auto].....	102
<input type="checkbox"/>	Administrator Password .....	102
<input type="checkbox"/>	User Password .....	102
<input type="checkbox"/>	Bootup NumLock State [On].....	103
<input type="checkbox"/>	Quiet Boot [Enabled] .....	104
<input type="checkbox"/>	UEFI Boot [Disabled] .....	104
<input type="checkbox"/>	Launch PXE OpROM [Disabled].....	104
<input type="checkbox"/>	Option ROM Messages [Force BIOS].....	104
<input type="checkbox"/>	Save Changes and Reset .....	105
<input type="checkbox"/>	Discard Changes and Reset .....	105
<input type="checkbox"/>	Restore Defaults .....	105
<input type="checkbox"/>	Save as User Defaults .....	106
<input type="checkbox"/>	Restore User Defaults .....	106

Appendix

**D**

# Terminology

---

## NANO-BT EPIC SBC

<b>AC '97</b>	Audio Codec 97 (AC'97) refers to a codec standard developed by Intel® in 1997.
<b>ACPI</b>	Advanced Configuration and Power Interface (ACPI) is an OS-directed configuration, power management, and thermal management interface.
<b>AHCI</b>	Advanced Host Controller Interface (AHCI) is a SATA Host controller register-level interface.
<b>ATA</b>	The Advanced Technology Attachment (ATA) interface connects storage devices including hard disks and CD-ROM drives to a computer.
<b>ARMD</b>	An ATAPI Removable Media Device (ARMD) is any ATAPI device that supports removable media, besides CD and DVD drives.
<b>ASKIR</b>	Amplitude Shift Keyed Infrared (ASKIR) is a form of modulation that represents a digital signal by varying the amplitude (“volume”) of the signal. A low amplitude signal represents a binary 0, while a high amplitude signal represents a binary 1.
<b>BIOS</b>	The Basic Input/Output System (BIOS) is firmware that is first run when the computer is turned on and can be configured by the end user
<b>CODEC</b>	The Compressor-Decompressor (CODEC) encodes and decodes digital audio data on the system.
<b>CMOS</b>	Complimentary metal-oxide-conductor is an integrated circuit used in chips like static RAM and microprocessors.
<b>COM</b>	COM refers to serial ports. Serial ports offer serial communication to expansion devices. The serial port on a personal computer is usually a male D-sub 9 connector.
<b>DAC</b>	The Digital-to-Analog Converter (DAC) converts digital signals to analog signals.



<b>DDR</b>	Double Data Rate refers to a data bus transferring data on both the rising and falling edges of the clock signal.
<b>DMA</b>	Direct Memory Access (DMA) enables some peripheral devices to bypass the system processor and communicate directly with the system memory.
<b>DIMM</b>	Dual Inline Memory Modules are a type of RAM that offer a 64-bit data bus and have separate electrical contacts on each side of the module.
<b>DIO</b>	The digital inputs and digital outputs are general control signals that control the on/off circuit of external devices or TTL devices. Data can be read or written to the selected address to enable the DIO functions.
<b>EHCI</b>	The Enhanced Host Controller Interface (EHCI) specification is a register-level interface description for USB 2.0 Host Controllers.
<b>EIDE</b>	Enhanced IDE (EIDE) is a newer IDE interface standard that has data transfer rates between 4.0 MBps and 16.6 MBps.
<b>EIST</b>	Enhanced Intel® SpeedStep Technology (EIST) allows users to modify the power consumption levels and processor performance through application software. The application software changes the bus-to-core frequency ratio and the processor core voltage.
<b>FSB</b>	The Front Side Bus (FSB) is the bi-directional communication channel between the processor and the Northbridge chipset.
<b>GbE</b>	Gigabit Ethernet (GbE) is an Ethernet version that transfers data at 1.0 Gbps and complies with the IEEE 802.3-2005 standard.
<b>GPIO</b>	General purpose input
<b>HDD</b>	Hard disk drive (HDD) is a type of magnetic, non-volatile computer storage device that stores digitally encoded data.
<b>ICH</b>	The Input/Output Control Hub (ICH) is an Intel® Southbridge chipset.

## NANO-BT EPIC SBC

<b>IrDA</b>	Infrared Data Association (IrDA) specify infrared data transmission protocols used to enable electronic devices to wirelessly communicate with each other.
<b>L1 Cache</b>	The Level 1 Cache (L1 Cache) is a small memory cache built into the system processor.
<b>L2 Cache</b>	The Level 2 Cache (L2 Cache) is an external processor memory cache.
<b>LCD</b>	Liquid crystal display (LCD) is a flat, low-power display device that consists of two polarizing plates with a liquid crystal panel in between.
<b>LVDS</b>	Low-voltage differential signaling (LVDS) is a dual-wire, high-speed differential electrical signaling system commonly used to connect LCD displays to a computer.
<b>POST</b>	The Power-on Self Test (POST) is the pre-boot actions the system performs when the system is turned-on.
<b>RAM</b>	Random Access Memory (RAM) is volatile memory that loses data when power is lost. RAM has very fast data transfer rates compared to other storage like hard drives.
<b>SATA</b>	Serial ATA (SATA) is a serial communications bus designed for data transfers between storage devices and the computer chipsets. The SATA bus has transfer speeds up to 1.5 Gbps and the SATA II bus has data transfer speeds of up to 3.0 Gbps.
<b>S.M.A.R.T</b>	Self Monitoring Analysis and Reporting Technology (S.M.A.R.T) refers to automatic status checking technology implemented on hard disk drives.
<b>UART</b>	Universal Asynchronous Receiver-transmitter (UART) is responsible for asynchronous communications on the system and manages the system's serial communication (COM) ports.
<b>UHCI</b>	The Universal Host Controller Interface (UHCI) specification is a register-level interface description for USB 1.1 Host Controllers.

**USB**

The Universal Serial Bus (USB) is an external bus standard for interfacing devices. USB 1.1 supports 12Mbps data transfer rates and USB 2.0 supports 480Mbps data transfer rates.

**VGA**

The Video Graphics Array (VGA) is a graphics display system developed by IBM.

Appendix

E

# Watchdog Timer

---



**NOTE:**

The following discussion applies to DOS environment. Contact IEI support or visit the IEI website for specific drivers for other operating systems.

The Watchdog Timer is provided to ensure that standalone systems can always recover from catastrophic conditions that cause the CPU to crash. This condition may have occurred by external EMIs or a software bug. When the CPU stops working correctly, Watchdog Timer either performs a hardware reset (cold boot) or a Non-Maskable Interrupt (NMI) to bring the system back to a known state.

A BIOS function call (INT 15H) is used to control the Watchdog Timer.

INT 15H:

<b>AH – 6FH Sub-function:</b>	
AL – 2:	Sets the Watchdog Timer's period.
BL:	Time-out value (Its unit-second is dependent on the item "Watchdog Timer unit select" in CMOS setup).

**Table E-1: AH-6FH Sub-function**

Call sub-function 2 to set the time-out period of Watchdog Timer first. If the time-out value is not zero, the Watchdog Timer starts counting down. When the timer value reaches zero, the system resets. To ensure that this reset condition does not occur, calling sub-function 2 must periodically refresh the Watchdog Timer. However, the watchdog timer is disabled if the time-out value is set to zero.

A tolerance of at least 10% must be maintained to avoid unknown routines within the operating system (DOS), such as disk I/O that can be very time-consuming.



## NANO-BT EPIC SBC

**NOTE:**

When exiting a program it is necessary to disable the Watchdog Timer, otherwise the system resets.

**EXAMPLE PROGRAM:**

**; INITIAL TIMER PERIOD COUNTER**

;

**W\_LOOP:**

;

```

MOV      AX, 6F02H      ;setting the time-out value
MOV      BL, 30         ;time-out value is 48 seconds
INT      15H

```

;

**; ADD THE APPLICATION PROGRAM HERE**

;

```

CMP      EXIT_AP, 1     ;is the application over?
JNE      W_LOOP        ;No, restart the application

```

```

MOV      AX, 6F02H      ;disable Watchdog Timer
MOV      BL, 0          ;
INT      15H

```

;

**; EXIT ;**

Appendix

**F**

# Digital I/O Interface

---

## NANO-BT EPIC SBC

The DIO connector on the NANO-BT is interfaced to GPIO ports on the Super I/O chipset. The DIO has both 8-bit digital inputs and 8-bit digital outputs. The digital inputs and digital outputs are generally control signals that control the on/off circuit of external devices or TTL devices. Data can be read or written to the selected address to enable the DIO functions.



### NOTE:

For further information, please refer to the datasheet for the Super I/O chipset.

The BIOS interrupt call **INT 15H** controls the digital I/O.

### INT 15H:

<b>AH – 6FH</b>	
<u>Sub-function:</u>	
<b>AL – 8</b>	: Set the digital port as INPUT
<b>AL</b>	: Digital I/O input value

### Assembly Language Sample 1

```
MOV     AX, 6F08H      ; setting the digital port as input
INT     15H           ;
```

**AL low byte = value**

<b>AH – 6FH</b>	
<u>Sub-function:</u>	
<b>AL – 9</b>	: Set the digital port as OUTPUT
<b>BL</b>	: Digital I/O output value

### Assembly Language Sample 2

```
MOV    AX, 6F09H      ; setting the digital port as output  
MOV    BL, 09H        ; digital value is 09H  
INT    15H           ;
```

Digital Output is 1001b

Appendix

G

# Hazardous Materials Disclosure

---



The details provided in this appendix are to ensure that the product is compliant with the Peoples Republic of China (China) RoHS standards. The table below acknowledges the presences of small quantities of certain materials in the product, and is applicable to China RoHS only.

A label will be placed on each product to indicate the estimated “Environmentally Friendly Use Period” (EFUP). This is an estimate of the number of years that these substances would “not leak out or undergo abrupt change.” This product may contain replaceable sub-assemblies/components which have a shorter EFUP such as batteries and lamps. These components will be separately marked.

Please refer to the following table.

Part Name	Toxic or Hazardous Substances and Elements					
	Lead (Pb)	Mercury (Hg)	Cadmium (Cd)	Hexavalent Chromium (CR(VI))	Polybrominated Biphenyls (PBB)	Polybrominated Diphenyl Ethers (PBDE)
Housing	O	O	O	O	O	O
Display	O	O	O	O	O	O
Printed Circuit Board	O	O	O	O	O	O
Metal Fasteners	O	O	O	O	O	O
Cable Assembly	O	O	O	O	O	O
Fan Assembly	O	O	O	O	O	O
Power Supply Assemblies	O	O	O	O	O	O
Battery	O	O	O	O	O	O

O: This toxic or hazardous substance is contained in all of the homogeneous materials for the part is below the limit requirement in SJ/T11363-2006 (now replaced by GB/T 26572-2011).

X: This toxic or hazardous substance is contained in at least one of the homogeneous materials for this part is above the limit requirement in SJ/T11363-2006 (now replaced by GB/T 26572-2011).

## NANO-BT EPIC SBC

此附件旨在确保本产品符合中国 RoHS 标准。以下表格标示此产品中某有毒物质的含量符合中国 RoHS 标准规定的限量要求。

本产品上会附有“环境友好使用期限”的标签，此期限是估算这些物质“不会有泄漏或突变”的年限。本产品可能包含有较短的环境友好使用期限的可替换元件，像是电池或灯管，这些元件将会单独标示出来。

部件名称	有毒有害物质或元素					
	铅 (Pb)	汞 (Hg)	镉 (Cd)	六价铬 (CR(VI))	多溴联苯 (PBB)	多溴二苯 醚 (PBDE)
壳体	○	○	○	○	○	○
显示	○	○	○	○	○	○
印刷电路板	○	○	○	○	○	○
金属螺帽	○	○	○	○	○	○
电缆组装	○	○	○	○	○	○
风扇组装	○	○	○	○	○	○
电力供应组装	○	○	○	○	○	○
电池	○	○	○	○	○	○

○: 表示该有毒有害物质在该部件所有物质材料中的含量均在 SJ/T 11363-2006 (现由 GB/T 26572-2011 取代) 标准规定的限量要求以下。

X: 表示该有毒有害物质至少在该部件的某一均质材料中的含量超出 SJ/T 11363-2006 (现由 GB/T 26572-2011 取代) 标准规定的限量要求。