



MODEL:
LCD-KIT-F Series

12.1" ~ 19" Open Frame LCD Monitor

VGA, DVI-D, RoHS

User Manual

Revision

Date	Version	Changes
6 June, 2016	1.00	Initial release

Copyright

COPYRIGHT NOTICE

The information in this document is subject to change without prior notice in order to improve reliability, design and function and does not represent a commitment on the part of the manufacturer.

In no event will the manufacturer be liable for direct, indirect, special, incidental, or consequential damages arising out of the use or inability to use the product or documentation, even if advised of the possibility of such damages.

This document contains proprietary information protected by copyright. All rights are reserved. No part of this manual may be reproduced by any mechanical, electronic, or other means in any form without prior written permission of the manufacturer.

TRADEMARKS

All registered trademarks and product names mentioned herein are used for identification purposes only and may be trademarks and/or registered trademarks of their respective owners.

Manual Conventions



WARNING

Warnings appear where overlooked details may cause damage to the equipment or result in personal injury. Warnings should be taken seriously.



CAUTION

Cautionary messages should be heeded to help reduce the chance of losing data or damaging the product.



NOTE

These messages inform the reader of essential but non-critical information. These messages should be read carefully as any directions or instructions contained therein can help avoid making mistakes.



HOT SURFACE

This symbol indicates a hot surface that should not be touched without taking care.

Table of Contents

1 INTRODUCTION	1
1.1 LCD-KIT-F SERIES LCD MONITOR OVERVIEW.....	2
1.2 FEATURES.....	2
1.3 MODEL VARIATIONS.....	3
1.4 APPLICATIONS.....	4
1.5 EXTERNAL OVERVIEW.....	4
1.5.1 Front View.....	4
1.5.2 Rear View.....	4
1.5.3 Connectors.....	5
1.6 SERIES SPECIFICATIONS.....	6
1.7 CERTIFICATIONS.....	7
2 MECHANICAL OVERVIEW	8
2.1 INTRODUCTION.....	9
2.2 REAR PANEL.....	9
2.3 CONNECTOR PANEL.....	9
2.3.1 Available Connectors.....	10
2.4 PHYSICAL DIMENSIONS.....	10
2.4.1 General Physical Dimensions.....	10
2.4.2 LCD-KIT-F-12A Physical Dimensions.....	11
2.4.3 LCD-KIT-F-15A Physical Dimensions.....	12
2.4.4 LCD-KIT-F-17A Physical Dimensions.....	13
2.4.5 LCD-KIT-F-19A Physical Dimensions.....	14
2.5 MOUNTING HOLES.....	15
3 LCD SPECIFICATIONS	16
3.1 LCD SPECIFICATIONS.....	17
3.1.1 LCD-KIT-F12A LCD Specifications.....	17
3.1.2 LCD-KIT-F15A LCD Specifications.....	17
3.1.3 LCD-KIT-F17A LCD Specifications.....	18

3.1.4 LCD-KIT-F19A LCD Specifications	19
3.2 POWER ADAPTERS	20
3.3 9~36V DC MODULE	20
4 AD BOARD	21
4.1 AD BOARD OVERVIEW	22
4.2 AV-60381 AD BOARD	22
4.2.1 AV-60381 Peripheral Interface Connectors	22
4.2.2 Backlight Inverter Connector (INVERTER1)	23
4.2.3 LVDS Connector (LVDS1)	24
4.2.4 OSD Keypad Connector (KEYPAD1)	24
4.2.5 Power Input Connector (PWR2)	25
4.2.6 RS-232 Connector for Touchscreen (RS232_1)	25
4.2.7 USB Connector for Touchscreen (USB_TOUCH1)	25
4.2.8 Touchscreen Connector (J1)	25
4.2.9 VGA Connector (VGA2)	26
4.2.10 Backlight Voltage Select Jumper (JP5)	26
4.2.11 LVDS Panel Voltage Select Jumper (JP2)	26
4.2.12 Power Input Setting Jumper (JP4)	27
4.2.13 Touchscreen Type Select Jumper (JP1)	27
5 INSTALLATION	28
5.1 INSTALLATION PRECAUTIONS	29
5.2 UNPACKING	30
5.2.1 Packaging	30
5.2.2 Unpacking Procedure	30
5.2.3 Packing List	31
5.3 PRE-INSTALLATION PREPARATION	32
5.3.1 Tools	32
5.4 CONNECTORS	32
5.4.1 VGA Connector	33
5.4.2 DVI-D Connector	33
5.4.3 12V Power Connector	34
5.4.4 9 V~36 V Terminal Block (Optional)	34
5.4.5 RS-232 for Touch Panel Connector	35

LCD-KIT-F

5.4.6 USB for Touch Panel Connector..... 36

5.5 MOUNTING THE LCD-KIT-F SERIES LCD MONITOR..... 36

 5.5.1 Panel Mounting..... 36

6 ON-SCREEN-DISPLAY (OSD) CONTROLS 41

 6.1 OSD KEYPAD 42

 6.2 OSD MENU STRUCTURE..... 43

 6.3 USING THE OSD..... 44

 6.3.1 Image Menu 44

 6.3.1.1 Color Setting..... 45

 6.3.2 Display Menu..... 46

 6.3.3 System Menu 47

 6.3.3.1 Input..... 48

 6.3.3.2 OSD Settings..... 49

7 SOFTWARE DRIVER..... 50

 7.1 INTRODUCTION 51

 7.2 RS-232 OR USB TOUCH SCREEN 51

 7.3 TOUCH PANEL DRIVER INSTALLATION..... 52

 7.4 CHANGE THE TOUCH SCREEN INTERFACE..... 55

 7.5 CALIBRATING THE TOUCH SCREEN..... 55

A REGULATORY COMPLIANCE..... 58

B SAFETY PRECAUTIONS..... 62

 B.1 SAFETY PRECAUTIONS..... 63

 B.1.1 General Safety Precautions..... 63

 B.1.2 Anti-static Precautions 64

 B.1.3 Product Disposal..... 65

 B.2 MAINTENANCE AND CLEANING PRECAUTIONS..... 66

 B.2.1 Maintenance and Cleaning..... 66

 B.2.2 Cleaning Tools..... 66

C SMARTOSD..... 68

 C.1 IEI SMARTOSD QUICK INSTALLATION GUIDE 69

 C.2 PRE-INSTALLATION NOTICE 69

 C.3 SMARTOSD INSTALLATION..... 69

<i>C.4 SOFTWARE ILLUSTRATION</i>	72
<i>C.4.1 Manage Page</i>	75
<i>C.4.2 EDID Page</i>	76
<i>C.4.3 Image Page</i>	77
<i>C.4.4 Display Page (for analog signal)</i>	78
<i>C.4.5 Color Page</i>	79
<i>C.4.6 PIP Page</i>	80
<i>C.4.7 System Page</i>	81
<i>C.4.8 About Page</i>	82
<i>C.5 SMARTOSD FAQ</i>	83
<i>C.5.1 Windows 2000 Installation Failure</i>	83
<i>C.5.2 Vista Installation Failure</i>	83
<i>C.5.3 Model Failure</i>	84
<i>C.5.4 DDC Port Failure</i>	85
<i>D HAZARDOUS MATERIALS DISCLOSURE</i>	86

List of Figures

Figure 1 1: LCD-KIT-F Series.....	2
Figure 1-2: Typical LCD-KIT-F Front View	4
Figure 1-3: Typical LCD-KIT-F Rear View.....	5
Figure 1-4: Typical LCD-KIT Connectors	6
Figure 2-1: Rear Panel.....	9
Figure 2-2: LCD-KIT-F-12A Physical Dimensions (millimeters).....	11
Figure 2-3: LCD-KIT-F-15A Physical Dimensions (millimeters).....	12
Figure 2-4: LCD-KIT-F-17A Physical Dimensions (millimeters).....	13
Figure 2-5: LCD-KIT-F-19A Physical Dimensions (millimeters).....	14
Figure 4-1: AV-60381 AD Board Layout Diagram	22
Figure 5-1: VGA Connector	33
Figure 5-2: DVI-D Connector	34
Figure 5-3: 12V Power Connector	34
Figure 5-4: 3-pin Terminal Block.....	35
Figure 5-5: RS-232 Touch Panel Connector	35
Figure 5-6: USB Touch Panel Connector	36
Figure 5-7: Mounting Clamps Holder.....	37
Figure 5-8: Mounting Clamps	37
Figure 5-9: Secure the Mounting Clamps Holders	38
Figure 5-10: Panel Mounting Clamp Position	38
Figure 5-11: Mounting Clamps Holder Dimensions	39
Figure 5-12: Ultra Set Plate Dimensions	39
Figure 5-13: Bolt Dimensions.....	39
Figure 5-14: Steering Button Dimensions.....	40
Figure 6-1: OSD Keypad	42
Figure 6-2: Image Menu	44
Figure 6-3: Color Settings.....	45
Figure 6-4: Display Menu	46
Figure 6-5: System Menu	47
Figure 6-6: Input Options.....	48

Figure 6-7: OSD Settings Menu	49
Figure 7-1: Setup Icon	52
Figure 7-2: Welcome Screen	53
Figure 7-3: License Agreement	53
Figure 7-4: Initiate Install	54
Figure 7-5: Installation Starts	54
Figure 7-6: Finish Installation	55
Figure 7-7: PenMount Monitor Icon	56
Figure 7-8: PenMount Monitor Popup Menu	56
Figure 7-9: Configuration Screen	56
Figure 7-10: Calibration Initiation Screen	57
Figure 7-11: Calibration Screen	57

List of Tables

Table 1-1: LCD-KIT-F Series Model Variations	3
Table 2-1: General Physical Dimensions	10
Table 2-2: Mounting Holes	15
Table 3-1: LCD-KIT-F12A LCD Specifications	17
Table 3-2: LCD-KIT-F15A LCD Specifications	18
Table 3-3: LCD-KIT-F17A LCD Specifications	19
Table 3-4: LCD-KIT-F19A LCD Specifications	19
Table 3-5: Power Adapter Specifications	20
Table 3-6: 9~36V DC Module Specifications	20
Table 4-1: AV-60381 Peripheral Interface Connectors.....	23
Table 4-2: Backlight Inverter Connector (INVERTER1) Pinouts	24
Table 4-3: LVDS Connector (LVDS1) Pinouts.....	24
Table 4-4: OSD Keypad Connector (KEYPAD1) Pinouts	24
Table 4-5: Power Input Connector (PWR2) Pinouts	25
Table 4-6: RS-232 Connector for Touchscreen (RS232_1) Pinouts	25
Table 4-7: USB Connector for Touchscreen (USB_TOUCH1) Pinouts.....	25
Table 4-8: Touchscreen Connector (J1) Pinouts.....	26
Table 4-9: VGA Connector (VGA2) Pinouts	26
Table 4-10: Backlight Voltage Select Jumper (JP5) Pinouts.....	26
Table 4-11: LVDS Panel Voltage Select Jumper (JP2) Pinouts.....	26
Table 4-12: Power Input Setting Jumper (JP4) Pinouts.....	27
Table 4-13: Touchscreen Type Select Jumper (JP1) Pinouts	27
Table 5-1: Rear Panel Connectors	33
Table 5-2: VGA Connector Pinouts	33
Table 5-3: DVI-D Connector Pinouts.....	34
Table 5-4: RS-232 Touch Panel Connector Pinouts.....	35
Table 5-5: USB Touch Panel Connector Pinouts	36
Table 6-1: OSD Control Buttons.....	42
Table 6-2: OSD Menu Structure.....	43
Table C-1: SmartOSD Menu Structure.....	74

Chapter

1

Introduction

1.1 LCD-KIT-F Series LCD Monitor Overview



Figure 1 1: LCD-KIT-F Series

The LCD-KIT-F series LCD monitor is the latest member of IEI's line of sophisticated LCD designs, and it has been improved to be RoHS compliant. It is designed to fit industrial automation, or any other applications that require minimum installation space and flexible configuration. Flexible analog or digital interfaces are provided for ease of connection with a management computer. If remote/non-attentive control is preferred, RS-232 or USB interfaces can be used with customized adapter cables.

1.2 Features

The LCD-KIT-F series have the following standard features:

- 12.1"~19" open frame architecture for embedded integration
- Over 350cd/m² high brightness and 50000hrs MTFB long lifetime panel
- Analog VGA or digital DVI interfaces support most of general systems
- Various touch panel solution : Resistive / Resistive touch windows / PCAP multi-touch
- Optional 9-36V DC module
- -20°C~60°C extended operating temperature
- Support software OSD for remote control applications

LCD-KIT-F

1.3 Model Variations

The LCD-KIT-F series offer the following model variations.

Model Number	Description
LCD-KIT-F12A-R10	12.1" 600 cd/m ² XGA open frame monitor, VGA and DVI-D input, R10
LCD-KIT-F15A-R10	15" 450 cd/m ² XGA open frame monitor, VGA and DVI-D input, R10
LCD-KIT-F17A-R10	17" 350 cd/m ² SXGA open frame monitor, VGA and DVI-D input, R10
LCD-KIT-F19A-R10	19" 350 cd/m ² SXGA open frame monitor, VGA and DVI-D input, R10
LCD-KIT-F12A/R-R10	12.1" 600 cd/m ² XGA open frame monitor, VGA and DVI-D input, Resistive touch screen RS-232/USB interface,R10
LCD-KIT-F15A/R-R10	15" 450 cd/m ² XGA open frame monitor, VGA and DVI-D input, Resistive touch screen RS-232/USB interface,R10
LCD-KIT-F17A/R-R10	17" 350 cd/m ² SXGA open frame monitor, VGA and DVI-D input, Resistive touch screen RS-232/USB interface,R10
LCD-KIT-F19A/R-R10	19" 350 cd/m ² SXGA open frame monitor, VGA and DVI-D input, Resistive touch screen RS-232/USB interface,R10
LCD-KIT-F12A/TW-R10	12.1" 600 cd/m ² XGA open frame monitor, VGA and DVI-D input, Resistive touch window RS-232/USB interface,R10
LCD-KIT-F15A/TW-R10	15" 450 cd/m ² XGA open frame monitor, VGA and DVI-D input, Resistive touch window RS-232/USB interface,R10
LCD-KIT-F17A/TW-R10	17" 350 cd/m ² SXGA open frame monitor, VGA and DVI-D input, Resistive touch window RS-232/USB interface,R10
LCD-KIT-F19A/TW-R10	19" 350 cd/m ² SXGA open frame monitor, VGA and DVI-D input, Resistive touch window RS-232/USB interface,R10
LCD-KIT-F12A/PC-R10	12.1" 600 cd/m ² XGA open frame monitor, VGA and DVI-D input, Projected capacitive touch window USB interface,R10
LCD-KIT-F15A/PC-R10	15" 450 cd/m ² XGA open frame monitor, VGA and DVI-D input, Projected capacitive touch window USB interface,R10
LCD-KIT-F17A/PC-R10	17" 350 cd/m ² SXGA open frame monitor, VGA and DVI-D input, Projected capacitive touch window USB interface,R10
LCD-KIT-F19A/PC-R10	19" 350 cd/m ² SXGA open frame monitor, VGA and DVI-D input, Projected capacitive touch window USB interface,R10

Table 1-1: LCD-KIT-F Series Model Variations

1.4 Applications

IEI's series of LCD monitors are designed for system manufacturers, integrators, or value-added resellers that want to provide all the performance, quality and reliability of an LCD display solution at a cost effective price. IEI's LCD kits offer additional components such as cables, an inverter and power supply with controller interfaces that include VGA and DVI.

1.5 External Overview

The following sections describe the physical layout of the LCD-KIT-F series LCD monitors.

1.5.1 Front View

The front of the LCD-KIT-F series LCD monitor is a flat panel TFT LCD screen attached to a metal chassis. Figure 1-2 shows a typical LCD-KIT-F front view.



Figure 1-2: Typical LCD-KIT-F Front View

1.5.2 Rear View

The rear of the LCD-KIT-F series LCD monitor is a metal chassis. An on screen display (OSD) control button panel, if present, is located vertically on the left side of the chassis with the following control buttons:

- LCD On/Off

LCD-KIT-F

- Auto
- Left
- Right
- Menu

The OSD panel also has one power LED.

Figure 1-3 shows a typical LCD-KIT-F rear panel.

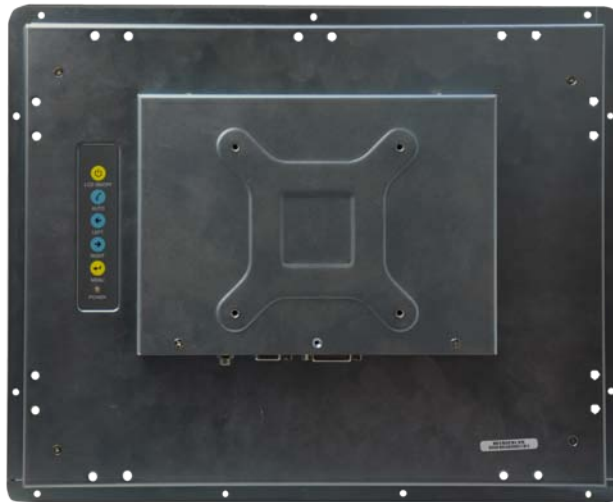

Figure 1-3: Typical LCD-KIT-F Rear View

1.5.3 Connectors

Each LCD-KIT series LCD monitor has a number of interface connectors on the I/O panel of the chassis (when viewing the rear panel). Figure 1-4 shows a typical LCD-KIT-F connector panel. Each model may include or exclude additional connectors. Refer to **Section 2.3** for listings of LCD-KIT-Fs and their connectors. All connectors are fully described in **Section 5.4**.

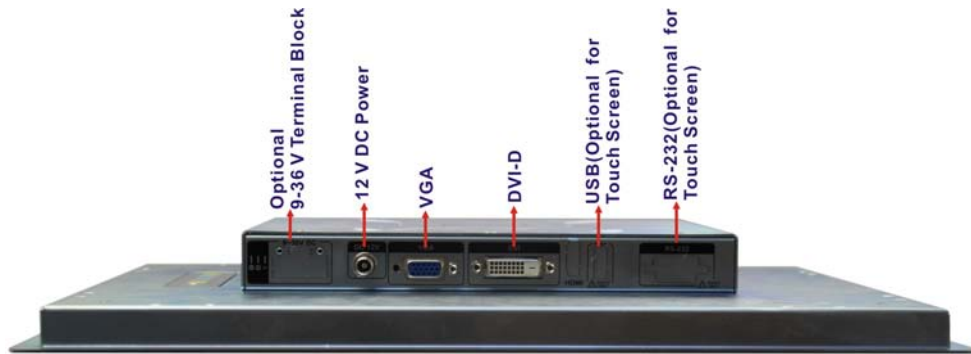

Figure 1-4: Typical LCD-KIT Connectors

1.6 Series Specifications

The table below shows the LCD-KIT-F Series specifications.

Model	LCD-KIT-F12A	LCD-KIT-F15A	LCD-KIT-F17A	LCD-KIT-F19A
LCD Size	12.1"	15"	17"	19"
Resolution	1024 x 768	1024 x 768	1280 x 1024	1280 x 1024
Brightness (cd/m2)	600	450	350	350
Contrast Ratio	700:1	800:1	800:1	1000:1
Display Color	16.2M	16.2M	16.7M	16.7M
Pixel Pitch (mm)	0.24	0.297	0.264	0.294
Viewing Angle (H/V)	160°/140°	160°/150°	170°/160°	170°/160°
AD Board	AV-60381			
Input Interface	Analog VGA, DVI-D, RS-232/USB(Optional for Touch)			
Touchscreen & controller	Resistive type 5-wire single touch / Penmount 6000 or Projected capacitive 2-point touch / EETI EXC7200 (Assembly by adhesive tape)			
OSD function	5 Key OSD			
Smart-OSD	Yes			
Dimensions (W x H x D mm)	323.8 x 263.8 x 40.3	380.1 x 304.6 x 43.2	410 x 343 x 49.4	449 x 374 x 49.45

LCD-KIT-F

Model	LCD-KIT-F12A	LCD-KIT-F15A	LCD-KIT-F17A	LCD-KIT-F19A
Operating Temperature	-20°C~60°C			
Storage Temperature	-20°C~70°C			
Humidity	10% to 95% (non-condensing)			
Input Voltage	12VDC, 9~36V(Optional, with LCD-KIT-F-936160-R10)			
Construction Material	sheet metal rear cover SPCC			
Mounting	Panel Mount, Rear Mount, VESA 100			

1.7 Certifications

All LCD-KIT-F series LCD monitor models comply with the following international standards:

- RoHS

For a more detailed description of these standards, please refer to **Appendix D**.

Chapter

2

Mechanical Overview

LCD-KIT-F

2.1 Introduction

This chapter describes the general mechanical overview of the LCD-KIT-F series LCD monitors including rear panel variations, available interfaces and overall dimensions.

2.2 Rear Panel

The following models of the LCD-KIT-F series LCD monitor have an OSD control panel located vertically along the left side of the rear panel:

- LCD-KIT-F12A
- LCD-KIT-F15A
- LCD-KIT-F17A
- LCD-KIT-F19A

Figure 2-1 shows the location of the rear panel OSD controls.

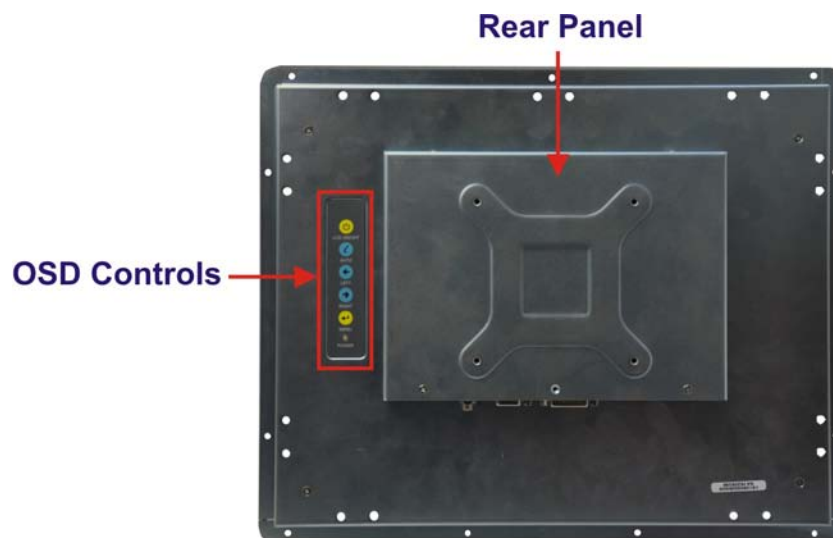

Figure 2-1: Rear Panel

2.3 Connector Panel

All external peripheral interface connectors are located on the rear panel of the LCD-KIT-F series LCD monitor. The following sections describe the rear panel variants and their associated connectors.

2.3.1 Available Connectors

There are a number of rear panel peripheral device connectors available for the LCD-KIT series LCD monitor.

- VGA connector
- DVI-D connector
- 12 V DC power connector
- 9~36 V DC terminal block (Optional)
- RS-232 connector (Optional for Touch)
- USB connector (Optional for Touch)

2.4 Physical Dimensions

The following sections describe the physical dimensions for each model of the LCD-KIT-F series LCD monitor.

2.4.1 General Physical Dimensions

General physical dimensions for the LCD-KIT-F series LCD monitors are shown in Table 2-1.

Model	Width (mm)	Height (mm)	Depth (mm)
LCD-KIT-F12A	323.8	263.8	40.3
LCD-KIT-F15A	380.1	304.6	43.2
LCD-KIT-F17A	410	343	49.4
LCD-KIT-F19A	449	374	49.45

Table 2-1: General Physical Dimensions

LCD-KIT-F

2.4.2 LCD-KIT-F-12A Physical Dimensions

The physical dimensions of the LCD-KIT-F-12A are shown in Figure 2-5.

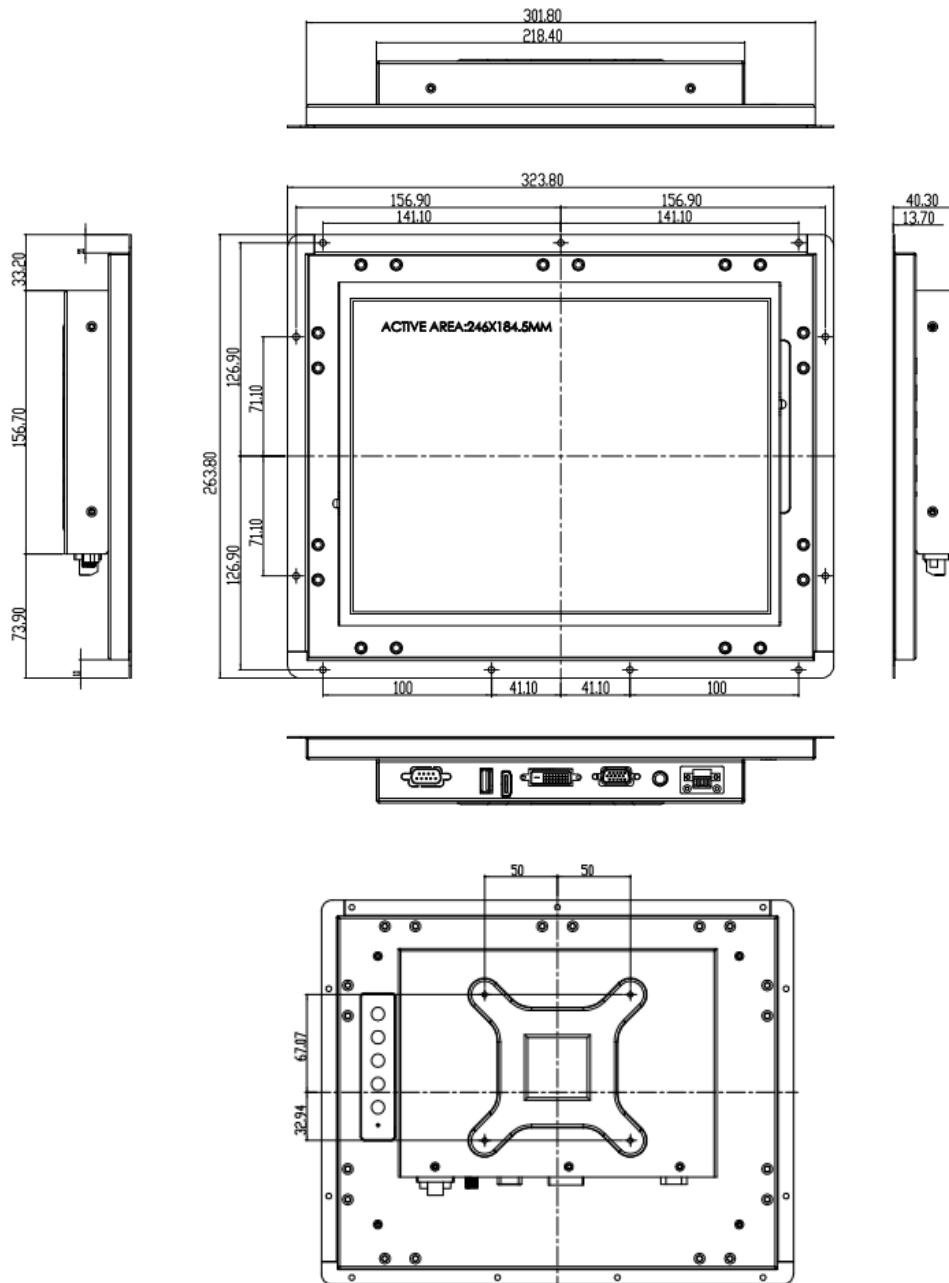

Figure 2-2: LCD-KIT-F-12A Physical Dimensions (millimeters)

2.4.3 LCD-KIT-F-15A Physical Dimensions

The physical dimensions of the LCD-KIT-F-15A are shown in Figure 2-3.

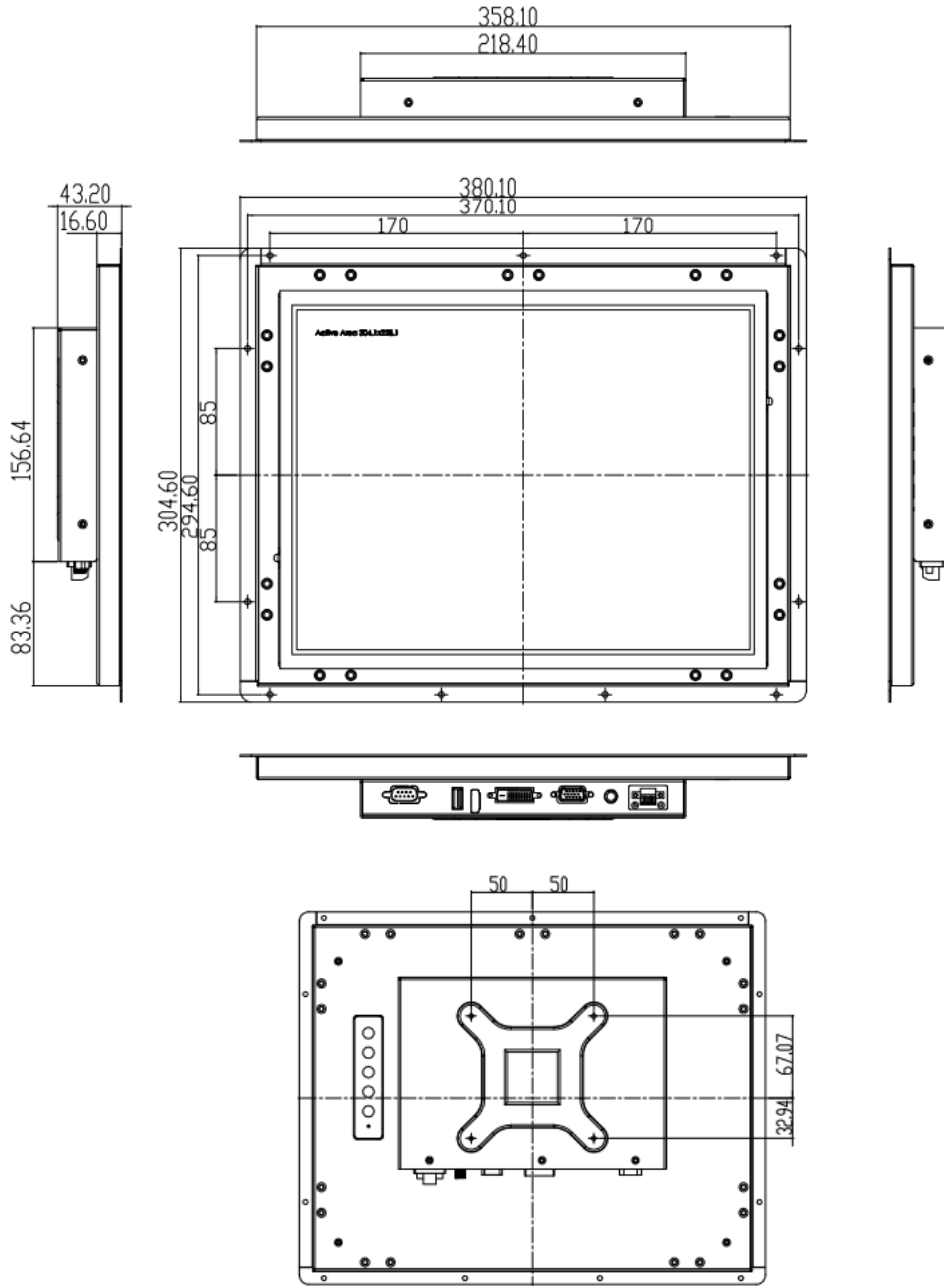

Figure 2-3: LCD-KIT-F-15A Physical Dimensions (millimeters)

LCD-KIT-F

2.4.4 LCD-KIT-F-17A Physical Dimensions

The physical dimensions of the LCD-KIT-F-17A are shown in Figure 2-4.

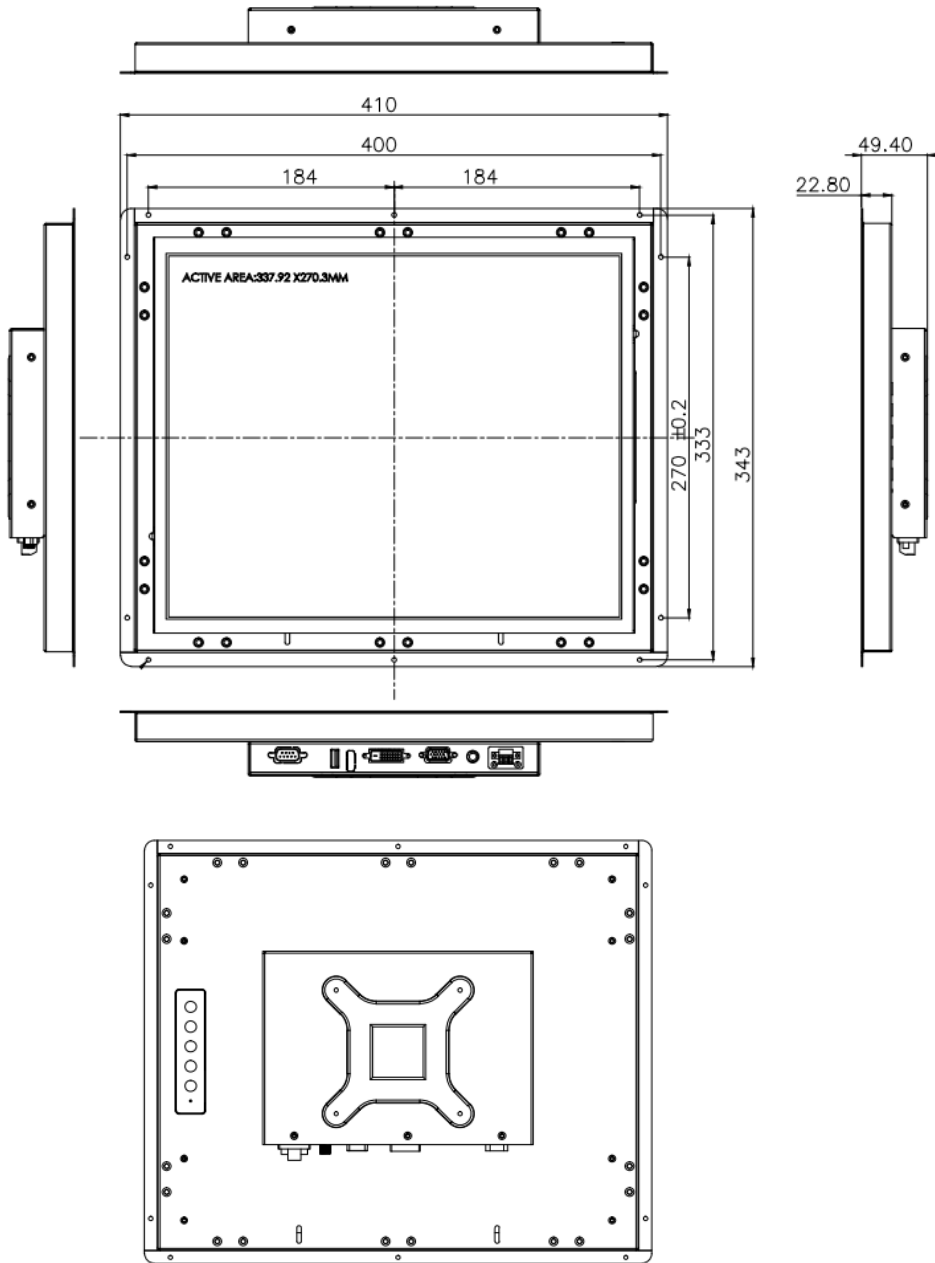

Figure 2-4: LCD-KIT-F-17A Physical Dimensions (millimeters)

2.4.5 LCD-KIT-F-19A Physical Dimensions

The physical dimensions of the LCD-KIT-F-19A are shown in Figure 2-5.

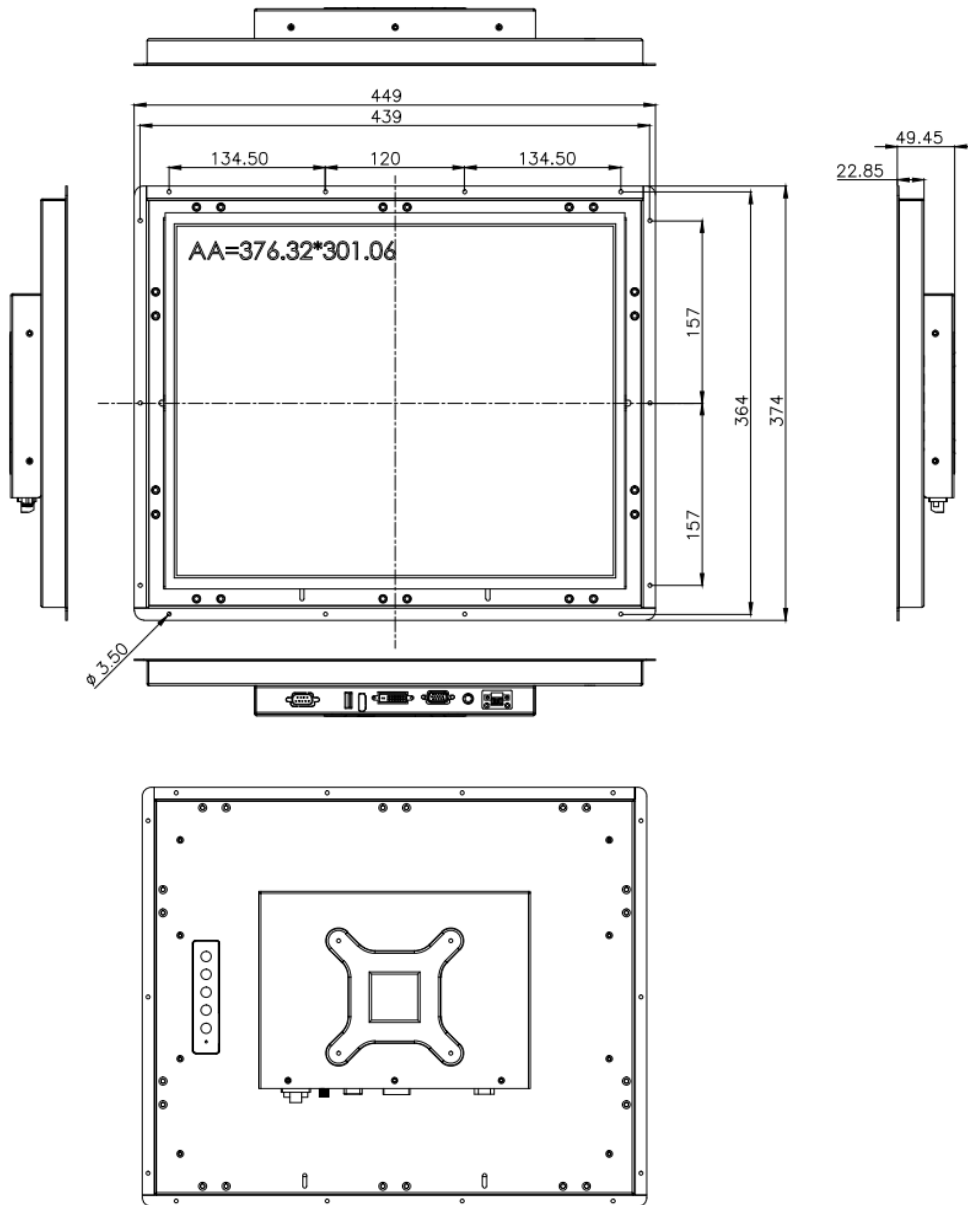

Figure 2-5: LCD-KIT-F-19A Physical Dimensions (millimeters)

LCD-KIT-F

2.5 Mounting Holes

Each LCD-KIT-F series LCD monitor has mounting holes located on the rear panel. Table 2-2 details the number of mounting holes for each model of the LCD-KIT series LCD monitor. Refer to **Section 2.4** for more information.

Model	Number of Mounting Holes
LCD-KIT-F12A	20
LCD-KIT-F15A	20
LCD-KIT-F17A	20
LCD-KIT-F19A	20

Table 2-2: Mounting Holes

Chapter

3

LCD Specifications

LCD-KIT-F

3.1 LCD Specifications

Detailed specifications for the LCD screens are listed in the following sections.

3.1.1 LCD-KIT-F12A LCD Specifications

The table below lists the **LCD-KIT-F12A** LCD specifications.

Items	LCD-KIT-F12A
Size	12.1
Backlight	LED
Brightness (cd/m ²)	600
Resolution	1024 x 768
Screen Scale	4:3
Life Time	50000H
Contrast Ratio	700:1
View Angle (H/V)	160/140
Interface	1ch LVDS
Operating Temperature	-30°C ~80°C
Active Area (mm)	245.75 x 184.32
Pixel Pitch (mm)	0.24
Mode	Normal White
Number of Colors	16.2M
Supply Voltage (V)	3.3

Table 3-1: LCD-KIT-F12A LCD Specifications

3.1.2 LCD-KIT-F15A LCD Specifications

The table below lists the **LCD-KIT-F15A** LCD specifications.

Items	LCD-KIT-F15A
Size	15"

Backlight	LED
Brightness (cd/m ²)	450
Resolution	1024 x 768
Screen Scale	4:3
Life Time	70000H
Contrast Ratio	800:1
View Angle (H/V)	160/150
Interface	1ch LVDS
Operating Temperature	-30°C ~85°C
Active Area (mm)	304.128 x 228.096
Pixel Pitch (mm)	0.297
Display Mode	Normal White
Display Color	16.2M
Supply Voltage (V)	3.3

Table 3-2: LCD-KIT-F15A LCD Specifications

3.1.3 LCD-KIT-F17A LCD Specifications

The table below lists the **LCD-KIT-F17A** LCD specifications.

Items	LCD-KIT-F17A
Size	17"
Backlight	LED
Brightness (cd/m ²)	350
Resolution	1280 x 1024
Screen Scale	4:3
Life Time	50000H
Contrast Ratio	800:1
View Angle (H/V)	170/160

LCD-KIT-F

Interface	2ch LVDS
Operating Temperature	-30°C ~70°C
Active Area (mm)	337.920 x 270.336
Pixel Pitch (mm)	0.264
Display Mode	Normal White
Display Color	16.7M
Supply Voltage (V)	5

Table 3-3: LCD-KIT-F17A LCD Specifications

3.1.4 LCD-KIT-F19A LCD Specifications

The table below lists the **LCD-KIT-F19A** LCD specifications.

Items	LCD-KIT-F19A
Size	19"
Backlight	LED
Brightness (cd/m ²)	350
Resolution	1280 x 1024
Screen Scale	4:3
Life Time	50000H
Contrast Ratio	1000:1
View Angle (H/V)	170/160
Active Area (mm)	304.1 x 228.1
Pixel Pitch (mm)	0.294
Display Mode	Normal White
Display Color	16.7M
Supply Voltage (V)	3.3

Table 3-4: LCD-KIT-F19A LCD Specifications

3.2 Power Adapters

Table 3-6 lists the power adapter specifications.

Model	FSP036-RBBN2
Input Voltage Range	90-264VAC
Input Frequency	47-63Hz
Output Voltage	12 V
Output Voltage	3 A
Output Watts	36W
Efficiency	86%
Operating Temperature	0°C~40°C
Storage Temperature	-20°C~70°C

Table 3-5: Power Adapter Specifications

3.3 9~36V DC Module

Table 3-6 lists the 9~36V DC module specifications.

Model	LCD-KIT-F-936160-R10
Input Voltage Range	9 V~36 V
Output Voltage	12 V
Output Watts	60W

Table 3-6: 9~36V DC Module Specifications

Chapter

4

AD Board

4.1 AD Board Overview

The LCD-KIT-F series LCD monitor AD board provides a wide variety of control interfaces. The following sections describe each AD board in detail.

4.2 AV-60381 AD Board

The connector locations of the AV-60381 are shown in Figure 4-1. The Pin 1 locations of the on-board connectors are also indicated in the diagrams below. The connector pinouts for these connectors are listed in the following sections.

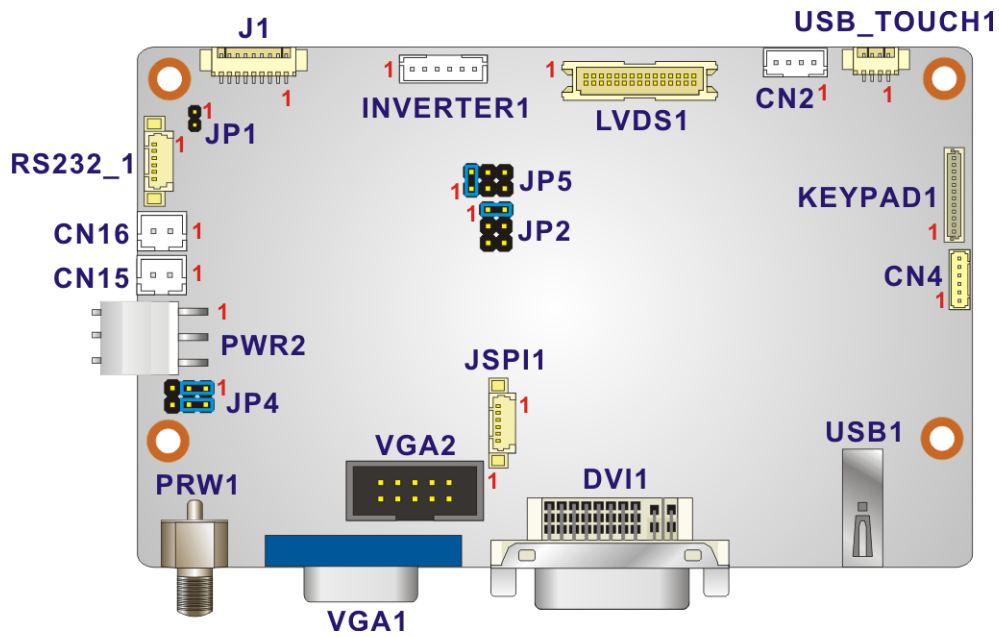

Figure 4-1: AV-60381 AD Board Layout Diagram

4.2.1 AV-60381 Peripheral Interface Connectors

Table 4-1 shows a list of the peripheral interface connectors on the AV-60381 AD board. Pinouts of the connectors that are used in the LCD-KIT-F can be found in the following sections.

Connector	Type	Label
Auto dimming connector	6-pin wafer, p=1.25 mm	CN4
Backlight Inverter connector	6-pin wafer, p=2.00 mm	INVERTER1

LCD-KIT-F

COM debug port connector	2-pin wafer, p=2.00 mm	CN2
LVDS connector	30-pin crimp, p=1.25 mm	LVDS1
OSD keypad connector	12-pin wafer, p=1.00 mm	KEYPAD1
Power input connector	3-pin wafer, p=3.96 mm	PWR2
Power input connector (+12 V)	2-pin wafer, p=2.00 mm	CN15
Power output connector	2-pin wafer, p=2.00 mm	CN16
RS-232 connector for touchscreen	6-pin wafer, p=1.25 mm	RS232_1
SPI flash connector	6-pin wafer, p=1.25 mm	JSPI1
USB connector for touchscreen	4-pin wafer, p=1.25 mm	USB_TOUCH1
Touchscreen connector	9-pin wafer, p=1.25 mm	J1
VGA connector	10-pin box header, p=2.00 mm	VGA2
Jumper	Type	Label
Backlight voltage select jumper	6-pin header, p=2.54 mm	JP5
LVDS panel voltage select jumper	6-pin header, p=2.54 mm	JP2
Power input setting jumper	6-pin header, p=2.54 mm	JP4
Touchscreen type select jumper	2-pin header, p=2.00 mm	JP1

Table 4-1: AV-60381 Peripheral Interface Connectors

4.2.2 Backlight Inverter Connector (INVERTER1)

PIN NO.	DESCRIPTION
1	BKL_POWER1
2	BKL_POWER1
3	ENABKL
4	BRIGHTNESS
5	GND

6	GND
---	-----

Table 4-2: Backlight Inverter Connector (INVERTER1) Pinouts

4.2.3 LVDS Connector (LVDS1)

PIN NO.	DESCRIPTION	PIN NO.	DESCRIPTION
1	GND	2	GND
3	A0P_C	4	A0M_C
5	A1P_C	6	A1M_C
7	A2P_C	8	A2M_C
9	CLK1P_C	10	CLK1M_C
11	A3P_C	12	A3M_C
13	GND	14	GND
15	A4P_C	16	A4M_C
17	A5P_C	18	A5M_C
19	A6P_C	20	A6M_C
21	CLK2P_C	22	CLK2M_C
23	A7P_C	24	A7M_C
25	GND	26	GND
27	VCC	28	VCC
29	VCC	30	VCC

Table 4-3: LVDS Connector (LVDS1) Pinouts

4.2.4 OSD Keypad Connector (KEYPAD1)

PIN NO.	DESCRIPTION	PIN NO.	DESCRIPTION
1	+5V_OSD(NC)	2	+12V(NC)
3	Left	4	Auto
5	Right	6	Power
7	Menu	8	Led_GREEN (UP)
9	Down (NC)	10	Led_RED
11	GND	12	+3.3V_DVDD(NC)

Table 4-4: OSD Keypad Connector (KEYPAD1) Pinouts

LCD-KIT-F

4.2.5 Power Input Connector (PWR2)

PIN NO.	DESCRIPTION
1	+9 V ~ +36 V to external power module
2	GND
3	+12 V input

Table 4-5: Power Input Connector (PWR2) Pinouts

4.2.6 RS-232 Connector for Touchscreen (RS232_1)

PIN NO.	DESCRIPTION
1	NDSR
2	NRX
3	NRTS
4	NTX
5	NDTR
6	GND

Table 4-6: RS-232 Connector for Touchscreen (RS232_1) Pinouts

4.2.7 USB Connector for Touchscreen (USB_TOUCH1)

PIN NO.	DESCRIPTION
1	VCC_TOUCH
2	D2F-
3	D2F+
4	GND

Table 4-7: USB Connector for Touchscreen (USB_TOUCH1) Pinouts

4.2.8 Touchscreen Connector (J1)

PIN NO.	DESCRIPTION	PIN NO.	DESCRIPTION
1	X+	2	X-
3	Y+	4	SENSE
5	X+	6	X-

PIN NO.	DESCRIPTION	PIN NO.	DESCRIPTION
7	Y+	8	Y+
9	GND		

Table 4-8: Touchscreen Connector (J1) Pinouts

4.2.9 VGA Connector (VGA2)

PIN NO.	DESCRIPTION	PIN NO.	DESCRIPTION
1	RED	2	SMCLK
3	GREEN	4	SMDATA
5	BLUE	6	GND
7	H-SYNC	8	GND
9	V-SYNC	10	GND

Table 4-9: VGA Connector (VGA2) Pinouts

4.2.10 Backlight Voltage Select Jumper (JP5)

	DESCRIPTION
Short 1-2	+3.3 V
Short 3-4	+5 V
Short 5-6	+12 V

Table 4-10: Backlight Voltage Select Jumper (JP5) Pinouts

4.2.11 LVDS Panel Voltage Select Jumper (JP2)

	DESCRIPTION
Short 1-2	+3.3 V (for 6.5" and 8")
Short 3-4	+5 V
Short 5-6	NC

Table 4-11: LVDS Panel Voltage Select Jumper (JP2) Pinouts

LCD-KIT-F

4.2.12 Power Input Setting Jumper (JP4)

	DESCRIPTION
Short 1-3, 2-4	+12 V from power jack (PRW1)
Short 3-5, 4-6	Input with external connector (external power module is needed)

Table 4-12: Power Input Setting Jumper (JP4) Pinouts

4.2.13 Touchscreen Type Select Jumper (JP1)

	DESCRIPTION
1	5-wire touchscreen
2	4-wire/8-wire touchscreen

Table 4-13: Touchscreen Type Select Jumper (JP1) Pinouts

Chapter

5

Installation

5.1 Installation Precautions

When installing the LCD-KIT-F series LCD monitor, please follow the precautions listed below:

- **Read the user manual:** The user manual provides a complete description of the LCD-KIT-F series LCD monitor, installation instructions and configuration options.
- **DANGER! Disconnect Power:** Power to the LCD monitor must be disconnected when installing the LCD-KIT-F series LCD monitor, or before any attempt is made to access the rear panel. Electric shock and personal injury might occur if the rear panel of the monitor is opened while the power cord is still connected to an electrical outlet.
- **Qualified Personnel:** The LCD-KIT-F series LCD monitor must be installed and operated only by trained and qualified personnel. Maintenance, upgrades, or repairs may only be carried out by qualified personnel who are familiar with the associated dangers.
- **Mounting:** Since the monitor may weigh up to 10 kg (not including a swing arm or other accessories), please ensure at least two people assist with mounting the monitor.
- **Air Circulation:** Make sure there is sufficient air circulation when installing the monitor. The monitor's cooling vents must not be obstructed by any objects. Blocking the vents can cause overheating of the monitor. Leave at least 5 cm of clearance around the monitor to prevent overheating.
- **Grounding:** The monitor should be properly grounded. The voltage feeds must not be overloaded. Adjust the cabling and provide external overcharge protection per the electrical values indicated on the label attached to the back of the monitor.
- **Anti-static Discharge:** The rear panel of the monitor must to be removed to configure the monitor's AD board voltage select jumper. When doing so, be sure the monitor is disconnected from its power source and take all necessary safety precautions to avoid electrocution and static discharge to the AD board. The use of a grounded wrist strap and an anti-static work pad is recommended.

5.2 Unpacking

5.2.1 Packaging

When shipped, the LCD-KIT-F series LCD monitor is wrapped in a plastic bag. Two polystyrene ends are placed on either side of the monitor. The monitor is then placed into a first (internal) cardboard box. This box is then sealed and placed into a second (external) cardboard box. The second box is also sealed. A bag containing accessory items is placed with the monitor in the internal (first) box.

5.2.2 Unpacking Procedure

To unpack the LCD-KIT-F series LCD monitor, follow the steps below:



WARNING:







The front side LCD screen has a protective plastic cover stuck to the screen. Only remove the plastic cover after the LCD-KIT-F series LCD monitor has been properly installed. This ensures the screen is protected during the installation process.

- Step 1:** Use box cutters, a knife or a sharp pair of scissors that seals the top side of the external (second) box.
- Step 2:** Open the external (second) box.
- Step 3:** Use box cutters, a knife or a sharp pair of scissors that seals the top side of the internal (first) box.
- Step 4:** Lift the monitor out of the boxes.
- Step 5:** Remove both polystyrene ends, one from each side.
- Step 6:** Pull the plastic cover off the LCD-KIT-F series LCD monitor.
- Step 7:** Make sure all the components listed in the packing list are present.

LCD-KIT-F

5.2.3 Packing List

All the monitors in the LCD-KIT-F series are shipped with the following components:

Quantity	Item	Image
Standard		
1	LCD-KIT series LCD monitor	
1	AC power adapter (P/N: 63040-010036-121-RS)	
1	AC power cable	
1	USB cable (for Touch) (P/N: 32001-006100-200-RS)	
1	VGA cable (P/N: 32000-036200-RS)	
1	Utility CD	
Optional		
	RS-232 cable (for Touch) (P/N: 32005-001100-200-RS)	
	DVI cable (P/N: 32000-086600-RS)	
	Panel mount kit (P/N: FPK-01-R10) (P/N: FPK-02-R10)	

If any of these items are missing or damaged, contact the distributor or sales representative immediately.

5.3 Pre-installation Preparation

5.3.1 Tools

Before installing the LCD-KIT-F series LCD monitor, make sure the following tools are on hand:

- **Philips (crosshead) screwdriver:** All the retention screws on the system are Philips screws.
- **Soft working mat:** When the LCD-KIT-F series LCD monitor is installed, the screen is placed on the working surface. It is therefore important to rest the MPC industrial workstation on a soft mat that cannot damage the LCD screen on the front of the LCD-KIT-F series LCD monitor.

5.4 Connectors

Table 5-1 lists the rear panel connectors for the LCD-KIT-F series LCD monitors.

LCD-KIT	DVI-D	VGA	12V DC Jack	9~36V Terminal Block	USB	RS-232
LCD-KIT-F12A-R10	Yes	Yes	Yes	Optional	No	No
LCD-KIT-F15A-R10	Yes	Yes	Yes	Optional	No	No
LCD-KIT-F17A-R10	Yes	Yes	Yes	Optional	No	No
LCD-KIT-F19A-R10	Yes	Yes	Yes	Optional	No	No
LCD-KIT-F12A/R-R10	Yes	Yes	Yes	Optional	Yes	Yes
LCD-KIT-F15A/R-R10	Yes	Yes	Yes	Optional	Yes	Yes
LCD-KIT-F17A/R-R10	Yes	Yes	Yes	Optional	Yes	Yes
LCD-KIT-F19A/R-R10	Yes	Yes	Yes	Optional	Yes	Yes
LCD-KIT-F12A/TW-R10	Yes	Yes	Yes	Optional	Yes	Yes
LCD-KIT-F15A/TW-R10	Yes	Yes	Yes	Optional	Yes	Yes
LCD-KIT-F17A/TW-R10	Yes	Yes	Yes	Optional	Yes	Yes

LCD-KIT-F

LCD-KIT	DVI-D	VGA	12V DC Jack	9~36V Terminal Block	USB	RS-232
LCD-KIT-F19A/TW-R10	Yes	Yes	Yes	Optional	Yes	Yes
LCD-KIT-F12A/PC-R10	Yes	Yes	Yes	Optional	Yes	No
LCD-KIT-F15A/PC-R10	Yes	Yes	Yes	Optional	Yes	No
LCD-KIT-F17A/PC-R10	Yes	Yes	Yes	Optional	Yes	No
LCD-KIT-F19A/PC-R10	Yes	Yes	Yes	Optional	Yes	No

Table 5-1: Rear Panel Connectors

5.4.1 VGA Connector

Use the rear panel standard 15-pin female VGA connector to connect the LCD monitor to the system graphics interface.

Pin	Description	Pin	Description	Pin	Description
1	RED	6	GROUND	11	NC
2	GREEN	7	GROUND	12	DDCDAT
3	BLUE	8	GROUND	13	HSYNC
4	NC	9	NC	14	VSYNC
5	GROUND	10	GROUND	15	DDCCLK

Table 5-2: VGA Connector Pinouts

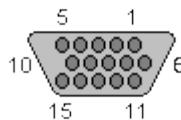

Figure 5-1: VGA Connector

5.4.2 DVI-D Connector

The 24-pin Digital Visual Interface (DVI) connector connects to high-speed, high-resolution digital displays. The DVI-D connector supports only digital signals.

PIN	DESCRIPTION	PIN	DESCRIPTION
1	TMDS Data2-	13	NC

2	TMDS Data2+	14	PVDD1
3	GND	15	GND
4	N/C	16	GND
5	N/C	17	TMDS Data0-
6	DDC Clock [SCL]	18	TMDS Data0+
7	DDC Data [SDA]	19	GND
8	Analog vertical sync	20	NC
9	TMDS Data1-	21	NC
10	TMDS Data1+	22	GND
11	GND	23	TMDS Clock +
12	NC	24	TMDS Clock -

Table 5-3: DVI-D Connector Pinouts

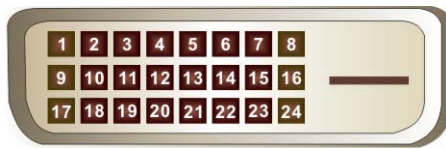

Figure 5-2: DVI-D Connector

5.4.3 12V Power Connector

Use the rear panel +12V DC jack to connect the monitor to a power source.



Figure 5-3: 12V Power Connector

5.4.4 9 V~36 V Terminal Block (Optional)

Connect the leads of 9 V ~ 36 V DC power supply into the terminal block. Make sure that the power and ground wires are attached to the correct sockets of the connector.

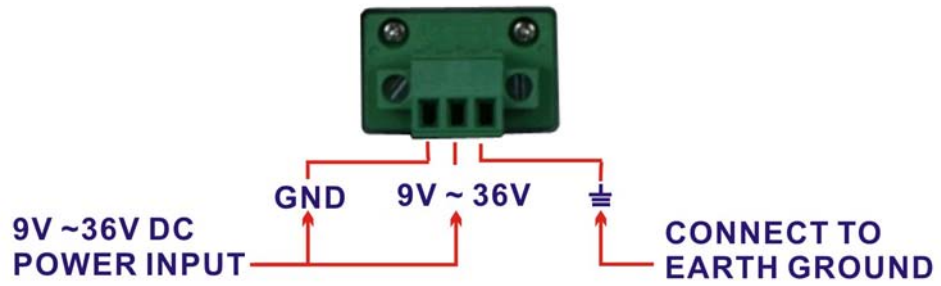

Figure 5-4: 3-pin Terminal Block

5.4.5 RS-232 for Touch Panel Connector

Use the rear panel standard RS-232 DB-9 female touch panel connector to connect the monitor to the system graphics interface.

PIN	DESCRIPTION	PIN	DESCRIPTION
1	N/A	6	NDSR
2	NRX	7	NRTS
3	NTX	8	N/A
4	NDTR	9	N/A
5	GND		

Table 5-4: RS-232 Touch Panel Connector Pinouts

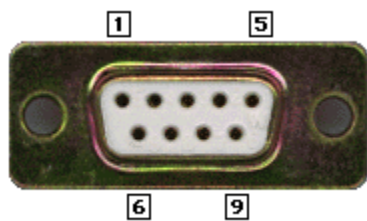

Figure 5-5: RS-232 Touch Panel Connector

5.4.6 USB for Touch Panel Connector

Use the rear panel standard USB touch panel connector to connect the monitor to the system graphics interface.

PIN	DESCRIPTION	PIN	DESCRIPTION
1	VCC	5	VCC
2	Data-	6	Data-
3	Data+	7	Data+
4	GND	8	GND

Table 5-5: USB Touch Panel Connector Pinouts

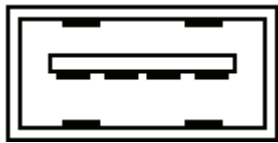

Figure 5-6: USB Touch Panel Connector

5.5 Mounting the LCD-KIT-F Series LCD Monitor

5.5.1 Panel Mounting

Each model of the LCD-KIT-F series LCD monitor has a series of mounting slots located on the top, side and bottom panels for mounting the monitor to a panel.

Table 2-2 lists the number of mounting clamps and holders required to mount the monitor to a panel.

Model	Mounting Clamps	Clamp Holders
LCD-KIT-F12A	10	10
LCD-KIT-F15A	10	10
LCD-KIT-F17A	10	10
LCD-KIT-F19A	10	10

Table 3-6: Panel Mounting Clamps

LCD-KIT-F

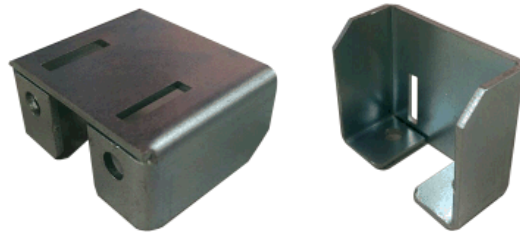

Figure 5-7: Mounting Clamps Holder



Figure 5-8: Mounting Clamps

To mount the LCD-KIT-F series LCD monitor into a panel, please follow the steps below.

- Step 1:** Select the position on the panel to mount the monitor.
- Step 2:** Cut out a section of the panel that corresponds to the rear panel dimensions of the monitor. Take care that the panel section that is cut out is smaller than the overall size of the metal frame that surrounds the monitor but just large enough for the rear panel of the monitor to fit through.
- Step 3:** Secure the mounting clamps holders to the corresponding holes on the rear of the monitor.

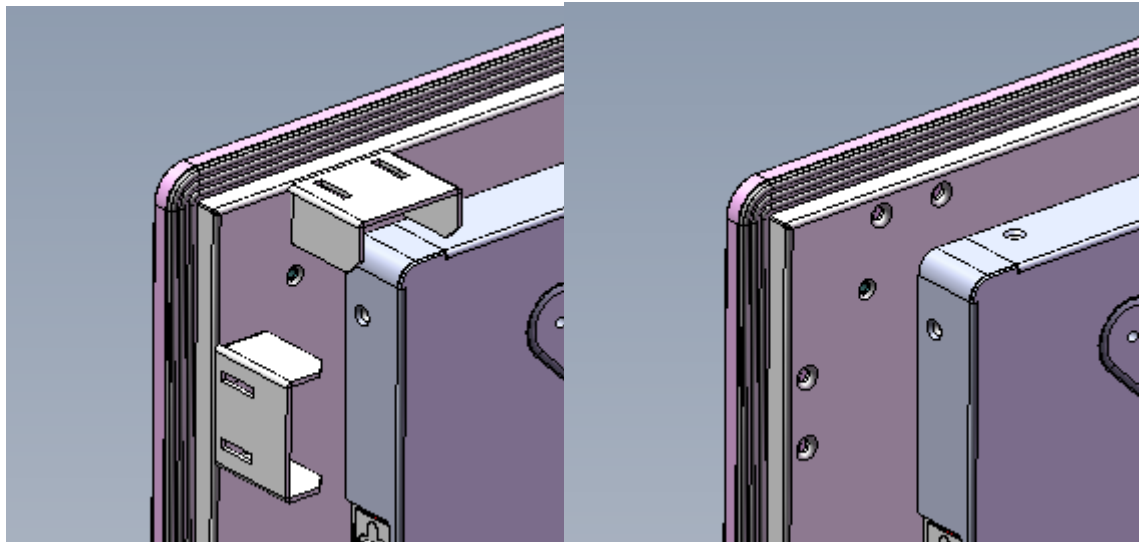

Figure 5-9: Secure the Mounting Clamps Holders

- Step 4:** Slide the monitor through the hole until the aluminum frame is flush against the panel.
- Step 5:** Insert the panel mounting clamps into the pre-formed holes of the clamp holders.

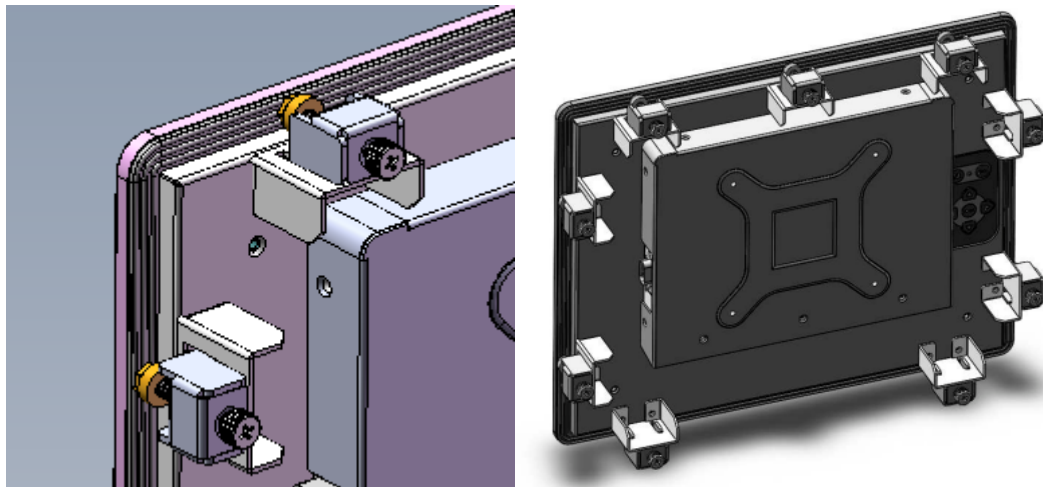

Figure 5-10: Panel Mounting Clamp Position

- Step 6:** Tighten the screws that pass through the panel mounting clamps until the plastic caps at the front of all the screws are firmly secured to the panel.

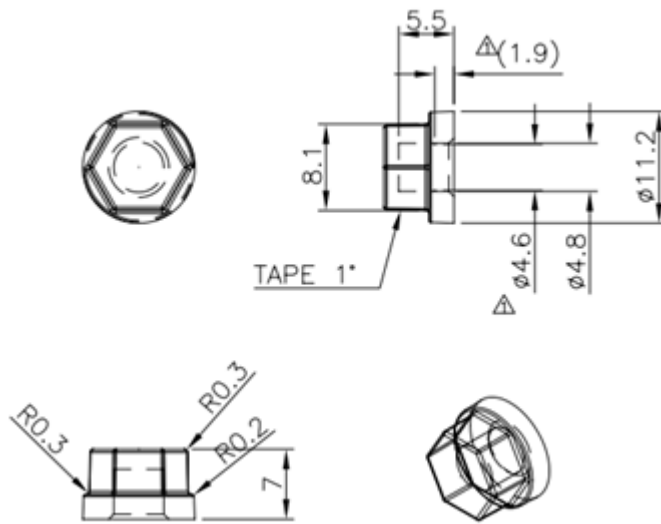

Figure 5-14: Steering Button Dimensions

Chapter

6

On-Screen-Display (OSD) Controls

6.1 OSD Keypad

There are several on-screen-display (OSD) control buttons of the OSD keypad on the monitor rear panel. Figure 6-1 shows the 5-key membrane OSD keypad of the LCD monitors.

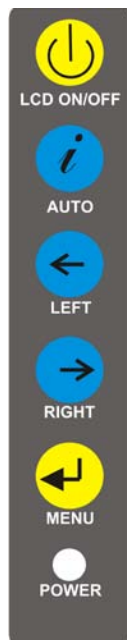

Figure 6-1: OSD Keypad

The function of each button is described in the following table.

LCD ON/OFF	Press this button to turn on or turn off the LCD screen.
AUTO	Press this button to automatically adjust the screen. When inside a menu, press this button to confirm the selection of the item.
LEFT	Press this button to decrease the value, or to scroll up from one selected item to another.
RIGHT	Press this button to increase the value, or to scroll down from one selected item to another.
MENU	Press this button to open the OSD window, exit the main menu or the current menu.

Table 6-1: OSD Control Buttons

6.2 OSD Menu Structure

Table 6-2 shows the OSD menu structure for all models of the DM-F series LCD monitor.

Level 0	Level 1	Level 2	Value	
Image	Brightness		0 to 100	
	Contrast		0 to 100	
	Sharpness		-4 to 4	
	Color	Auto		
		Color temp		5000K
				6500K
				9300K
				User
	Reset			
Display	Auto Adjust			
	Phase		0 to 100	
	Clock		0 to 100	
	Display Position			
	Display Modes			Gamma off
				Gamma 2.2
System	Input	Display Port		
		VGA		
		DVI /HDMI		
		autoscan		
	OSD Setting	Timer		10sec/30sec/60sec
		Rotation		0°/90°/180°/270°
		Position		
		Transparency		0 to 100
	Information			
	Reset			

Table 6-2: OSD Menu Structure

6.3 Using the OSD

OSD menu options are described below.

6.3.1 Image Menu

Image menu features are shown in Figure 6-2.

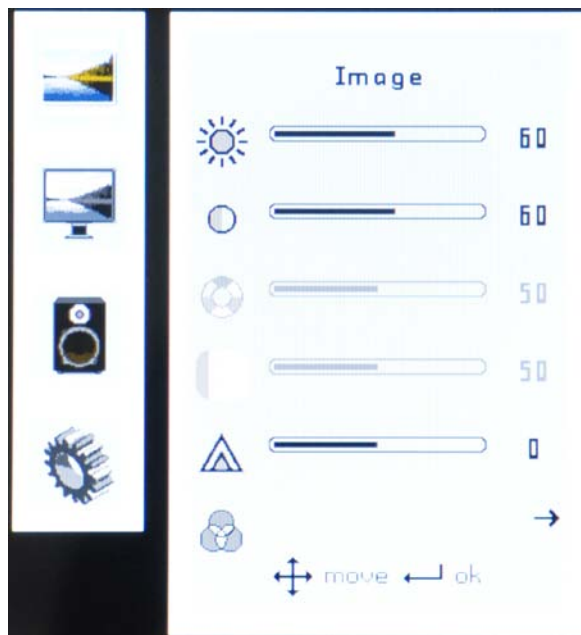

Figure 6-2: Image Menu

Brightness	The brightness option adjusts the brightness of screen. This function adjusts the offset value of ADC. Setting this value too high or too low will affect the quality of image.
Contrast	This function adjusts the gain value of ADC. Adjusting this value too high or too low will worsen the quality of image.
Sharpness	Adjusts the sharpness level. This option softens the edges around objects on the screen.
Color	Provides options for color settings. (Figure 6-3)

LCD-KIT-F

6.3.1.1 Color Setting

Color settings are shown in Figure 6-3.

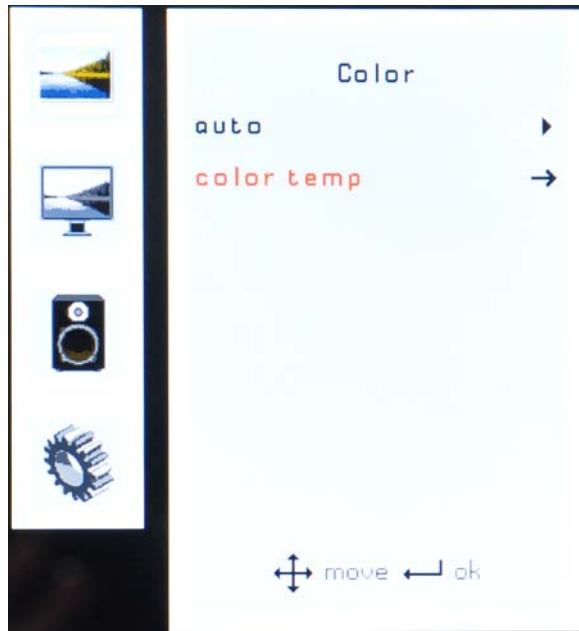

Figure 6-3: Color Settings

auto Automatically adjusts the color settings.

Color temp This item allows adjustment of the following items.

- **5000k** – NTSC standard Kelvin
- **6500k** – NTSC standard Kelvin
- **9300k** – NTSC standard Kelvin
- **User** – This item allows fine-tuning the balance among Red, Green, and Blue color hues if images look garish or unrealistic.

6.3.2 Display Menu

Display menu features are shown in Figure 6-4.

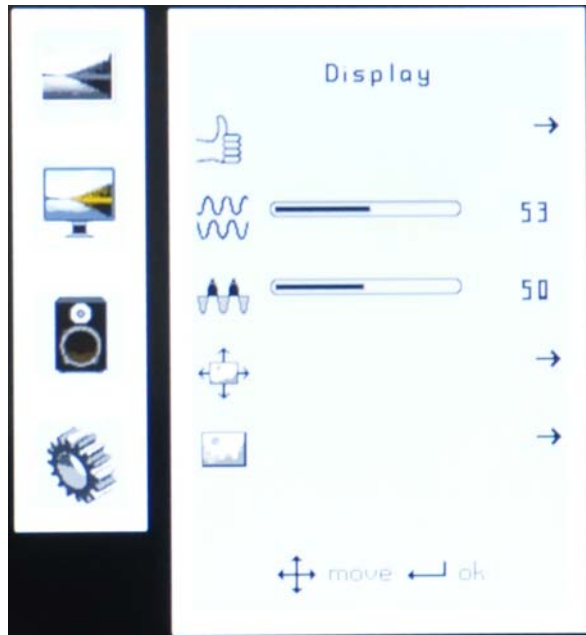

Figure 6-4: Display Menu

- Auto Adjust** Automatically adjusts the LCD screen position.
- Phase** Adjusts the input signal (analog only)
- Clock** Adjusts the dot clock position
- Display Position** Adjusts the horizontal and vertical position of the display screen
- Display Mode** This item allows adjustment of the Gamma.

LCD-KIT-F

6.3.3 System Menu

System menu features are shown in Figure 6-5.



Figure 6-5: System Menu

Input	Allows selection of input device to use. (Figure 6-6)
OSD Settings	Provides options for OSD configuration. (Figure 6-7)
Information	Provides information on the LCD monitor, such as firmware version, release date and input resolution.
Reset	Restores the default OSD settings. Note that this will restore all default display settings.

6.3.3.1 Input

Input options are shown in Figure 6-6.



Figure 6-6: Input Options

Input options are described below.

- | | |
|---------------------|--|
| Display Port | This item sets the input device to display port. |
| VGA | This item sets the input device to VGA. |
| HDMI | This item sets the input device to HDMI. |
| autoscan | Selects the input device to use automatically. |

6.3.3.2 OSD Settings

The OSD settings are shown in Figure 6-7.



Figure 6-7: OSD Settings Menu

OSD settings are described below.

Timer	Determines how many seconds the OSD screen stays on screen before it disappears when OSD is left unattended.
Rotation	Adjusts the OSD rotation angle on the screen.
Position	Adjusts the OSD position on the screen.
Transparency	Adjust the transparency of the OSD menu background.

Chapter

7

Software Driver

7.1 Introduction

The touch panel controller enables analog resistive touch panels for four-wire, five-wire & eight-wire models. The controller directly communicates with the PC system through the touch panel communications interface. The controller design is superior in sensitivity, accuracy, and friendly operation. The touch panel driver emulates the left mouse button and the right mouse button functions.

The touch panel driver supports the following operating systems:

- Microsoft® Windows® versions:
 - Microsoft® Windows® 2000
 - Microsoft® Windows® XP
 - Microsoft® Windows® 2003
 - Microsoft® Windows® 2008
 - Microsoft® Windows® Vista
 - Microsoft® Windows® 7
- Microsoft® Windows® CE versions:
 - Microsoft® Windows® CE 4.2
 - Microsoft® Windows® CE 5.0
 - Microsoft® Windows® CE 6.0
- Linux Kernel 2.6
- DOS

Driver installation is described below.

7.2 RS-232 or USB Touch Screen

Before installing the driver, connect the LCD-KIT-F monitor to the motherboard. The LCD-KIT-F monitors support touch screen modality through an RS-232 or USB interface connection. Decide through which interface the touch screen is to be controlled.

- **RS-232 Interface:** If the touch screen interface connection is an RS-232 connection, connect the RS-232 connector on the single board computer to the DB-9 connector of the LCD-KIT-F monitor.

- **USB Interface:** If the touch screen interface connection is a USB connection, connect the USB connector on the single board computer to the external USB port connector of the LCD-KIT-F monitor.

7.3 Touch Panel Driver Installation



WARNING:

Before the touch screen driver is installed, make sure the system is connected to the monitor with a USB cable or an RS-232 null cable. Also, make sure the VGA connector on the system is connected to the VGA connector on the bottom of the monitor.

To install the touch panel driver for the LCD-KIT-F, please follow the instructions below:

Step 7: Connect the LCD-KIT-F monitor to the single board computer. See above.

Step 8: Install the driver CD. Install the driver CD into the system to which the LCD-KIT-F monitor is connected.

Step 9: Select the **Touch Screen** option in the menu of driver CD. The directory in **Figure 7-1** appears.

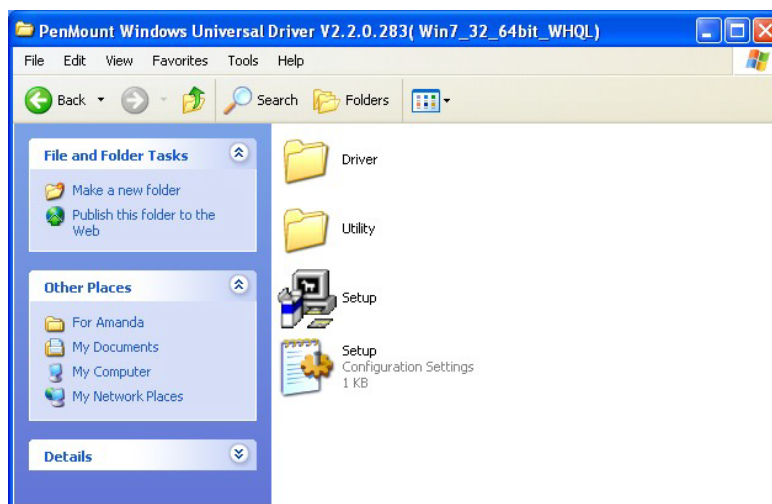

Figure 7-1: Setup Icon

LCD-KIT-F

Step 10: Double click the setup icon in **Figure 7-1**.

Step 11: The Welcome screen in **Figure 7-2** appears.



Figure 7-2: Welcome Screen

Step 12: Click **Next** to continue.

Step 13: The license agreement in **Figure 7-3** appears. Accept the terms of the agreement by clicking **I Agree**.

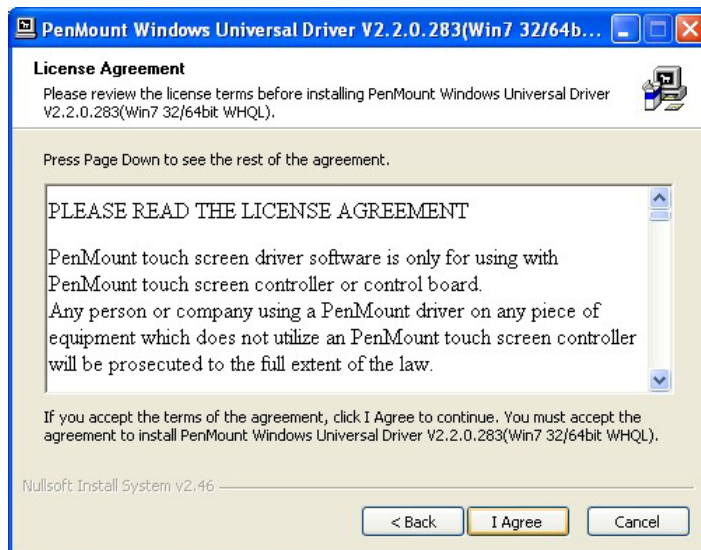

Figure 7-3: License Agreement

Step 14: The installation destination screen appears. See **Figure 7-4**. Click **Install**.

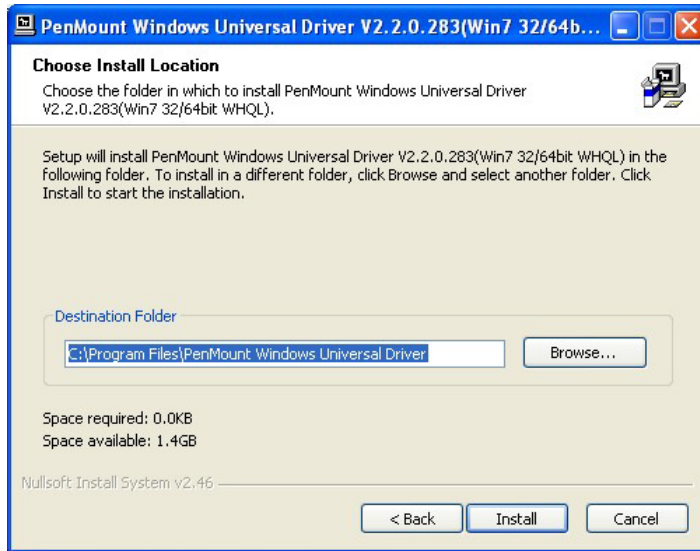

Figure 7-4: Initiate Install

Step 15: The installation of the program begins. See **Figure 7-5**.

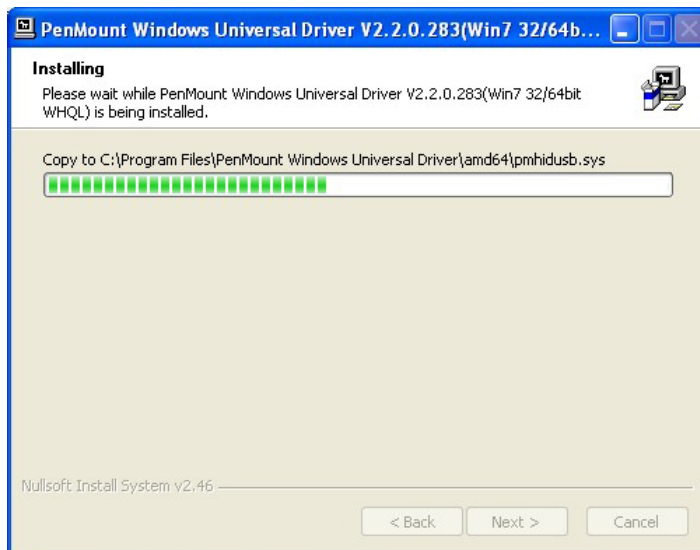

Figure 7-5: Installation Starts

Step 16: When the installation is complete, the complete screen appears. See **Figure 7-6**.

To complete the installation process click **Finish**.

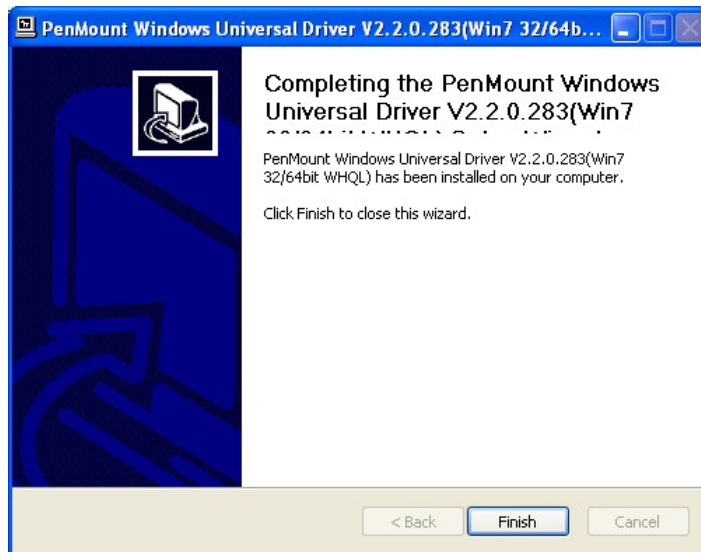

Figure 7-6: Finish Installation

7.4 Change the Touch Screen Interface

If the touch screen interface must be changed from an RS-232 interface to a USB interface or, from a USB interface to an RS-232 interface, the following steps must be followed.

Step 17: Uninstall the touch screen driver

Step 18: Remove the interface cable i.e. remove the RS-232 cable or the USB cable

Step 19: Install the new cable i.e. install the USB cable or the RS-232 cable.

Step 20: Reinstall the driver CD as described above.

7.5 Calibrating the Touch Screen

To calibrate the touch screen cursor with the motion of the touch screen pen (or finger), please follow the steps below:

Step 1: Make sure the system is properly connected through an RS-232 or a USB interface to the LCD-KIT-F monitor.

Step 2: Make sure the touch screen driver is properly installed.

LCD-KIT-F

Step 7: Double click the PenMount 6000 icon as shown in **Figure 7-9**.

Step 8: The calibration initiation screen in **Figure 7-10** appears.

Step 9: Select the Standard Calibration button as shown in **Figure 7-10**.

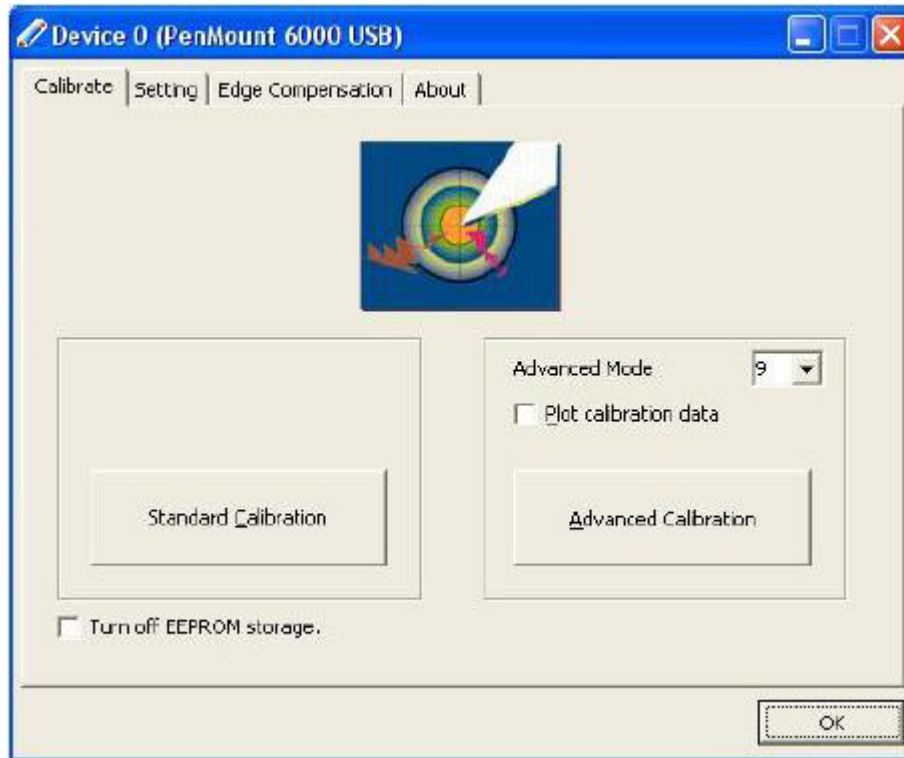

Figure 7-10: Calibration Initiation Screen

Step 10: The calibration screen in is shown. See **Figure 7-11**.



Touch the red square.

Figure 7-11: Calibration Screen

Step 11: Follow the instructions. The user is asked touch the screen at five specified points after which the screen is calibrated.

Appendix

A

Regulatory Compliance

DECLARATION OF CONFORMITY



This equipment is in conformity with the following EU directives:

- EMC Directive (2004/108/EC, 2014/30/EU)
- Low-Voltage Directive (2006/95/EC, 2014/35/EU)
- RoHS II Directive (2011/65/EU, 2015/863/EU)
- Ecodesign Directive 2009/125/EC

If the user modifies and/or install other devices in the equipment, the CE conformity declaration may no longer apply.

If this equipment has telecommunications functionality, it also complies with the requirements of the Radio Equipment Directive 2014/53/EU.

English

IEI Integration Corp declares that this equipment is in compliance with the essential requirements and other relevant provisions of Directive 2014/53/EU.

Български [Bulgarian]

IEI Integration Corp. декларира, че този оборудване е в съответствие със съществените изисквания и другите приложими правила на Директива 2014/53/EU.

Česky [Czech]

IEI Integration Corp tímto prohlašuje, že tento zařizení je ve shodě se základními požadavky a dalšími příslušnými ustanoveními směrnice 2014/53/EU.

Dansk [Danish]

IEI Integration Corp erklærer herved, at følgende udstyr overholder de væsentlige krav og øvrige relevante krav i direktiv 2014/53/EU.

Deutsch [German]

IEI Integration Corp, erklärt dieses Gerät entspricht den grundlegenden Anforderungen und den weiteren entsprechenden Vorgaben der Richtlinie 2014/53/EU.

Eesti [Estonian]

IEI Integration Corp deklareerib seadme seadme vastavust direktiivi 2014/53/EÜ põhinõuetele ja nimetatud direktiivist tulenevatele teistele asjakohastele sätetele.

Español [Spanish]

IEI Integration Corp declara que el equipo cumple con los requisitos esenciales y cualesquiera otras disposiciones aplicables o exigibles de la Directiva 2014/53/EU.

Ελληνική [Greek]

IEI Integration Corp ΔΗΛΩΝΕΙ ΟΤΙ ΕΞΟΠΛΙΣΜΟΣ ΣΥΜΜΟΡΦΩΝΕΤΑΙ ΠΡΟΣ ΤΙΣ ΟΥΣΙΩΔΕΙΣ ΑΠΑΙΤΗΣΕΙΣ ΚΑΙ ΤΙΣ ΛΟΙΠΕΣ ΣΧΕΤΙΚΕΣ ΔΙΑΤΑΞΕΙΣ ΤΗΣ ΟΔΗΓΙΑΣ 2014/53/EU.

Français [French]

IEI Integration Corp déclare que l'appareil est conforme aux exigences essentielles et aux autres dispositions pertinentes de la directive 2014/53/EU.

Italiano [Italian]

IEI Integration Corp dichiara che questo apparecchio è conforme ai requisiti essenziali ed alle altre disposizioni pertinenti stabilite dalla direttiva 2014/53/EU.

Latviski [Latvian]

IEI Integration Corp deklarē, ka iekārta atbilst būtiskajām prasībām un citiem ar to saistītajiem noteikumiem Direktīvas 2014/53/EU.

Lietuvių [Lithuanian]

IEI Integration Corp deklaruoja, kad šis įranga atitinka esminius reikalavimus ir kitas 2014/53/EU Direktyvos nuostatas.

Nederlands [Dutch]

IEI Integration Corp dat het toestel in overeenstemming is met de essentiële eisen en de andere relevante bepalingen van richtlijn 2014/53/EU.

Malti [Maltese]

IEI Integration Corp jiddikjara li dan prodott jikkonforma mal-ħtiġijiet essenzjali u ma provvedimenti oħrajn rilevanti li hemm fid-Dirrettiva 2014/53/EU.

Magyar [Hungarian]

IEI Integration Corp nyilatkozom, hogy a berendezés megfelel a vonatkozó alapvető követelményeknek és az 2014/53/EU irányelv egyéb előírásainak.

Polski [Polish]

IEI Integration Corp oświadcza, że wyrobu jest zgodny z zasadniczymi wymogami oraz pozostałymi stosownymi postanowieniami Dyrektywy 2014/53/EU.

Português [Portuguese]

IEI Integration Corp declara que este equipamento está conforme com os requisitos essenciais e outras disposições da Directiva 2014/53/EU.

Româna [Romanian]

IEI Integration Corp declară că acest echipament este în conformitate cu cerințele esențiale și cu celelalte prevederi relevante ale Directivei 2014/53/EU.

Slovensko [Slovenian]

IEI Integration Corp izjavlja, da je ta opreme v skladu z bistvenimi zahtevami in ostalimi relevantnimi določili direktive 2014/53/EU.

Slovensky [Slovak]

IEI Integration Corp týmto vyhlasuje, že zariadenia spĺňa základné požiadavky a všetky príslušné ustanovenia Smernice 2014/53/EU.

Suomi [Finnish]

IEI Integration Corp vakuuttaa täten että laitteet on direktiivin 2014/53/EU oleellisten vaatimusten ja sitä koskevien direktiivin muiden ehtojen mukainen.

Svenska [Swedish]

IEI Integration Corp förklarar att denna utrustningstyp står i överensstämmelse med de väsentliga egenskapskrav och övriga relevanta bestämmelser som framgår av direktiv 2014/53/EU.

Appendix

B

Safety Precautions

**WARNING:**

The precautions outlined in this chapter should be strictly followed. Failure to follow these precautions may result in permanent damage to the LCD-KIT-F.

B.1 Safety Precautions

Please follow the safety precautions outlined in the sections that follow:

B.1.1 General Safety Precautions

Please ensure the following safety precautions are adhered to at all times.

- **Follow the electrostatic precautions** outlined below whenever the device is opened.
- **Make sure the power is turned off and the power cord is disconnected** whenever the LCD-KIT-F is being installed, moved or modified.
- **To prevent the risk of electric shock, make sure power cord is unplugged from wall socket.** To fully disengage the power to the unit, please disconnect the power cord from the AC outlet. Refer servicing to qualified service personnel. The AC outlet shall be readily available and accessible.
- **Do not apply voltage levels that exceed the specified voltage range.** Doing so may cause fire and/or an electrical shock. Use a power cord that matches the voltage of the power outlet, which has been approved and complies with the safety standard of your particular country.
- **Electric shocks can occur** if the LCD-KIT-F chassis is opened when it is running. To avoid risk of electric shock, this device must only be connected to a supply mains with protective earth.
- **Do not drop or insert any objects** into the ventilation openings of the LCD-KIT-F.

- **If considerable amounts of dust, water, or fluids enter the device**, turn off the power supply immediately, unplug the power cord, and contact the LCD-KIT-F vendor.
- **DO NOT:**
 - Drop the device against a hard surface.
 - Strike or exert excessive force onto the LCD panel.
 - Touch any of the LCD panels with a sharp object
 - In a site where the ambient temperature exceeds the rated temperature

B.1.2 Anti-static Precautions



WARNING:

Failure to take ESD precautions during the installation of the LCD-KIT-F may result in permanent damage to the LCD-KIT-F and severe injury to the user.

Electrostatic discharge (ESD) can cause serious damage to electronic components, including the LCD-KIT-F. Dry climates are especially susceptible to ESD. It is therefore critical that whenever the LCD-KIT-F is opened and any of the electrical components are handled, the following anti-static precautions are strictly adhered to.

- **Wear an anti-static wristband:** Wearing a simple anti-static wristband can help to prevent ESD from damaging any electrical component.
- **Self-grounding:** Before handling any electrical component, touch any grounded conducting material. During the time the electrical component is handled, frequently touch any conducting materials that are connected to the ground.
- **Use an anti-static pad:** When configuring or working with an electrical component, place it on an anti-static pad. This reduces the possibility of ESD damage.
- **Only handle the edges of the electrical component:** When handling the electrical component, hold the electrical component by its edges.

B.1.3 Product Disposal

**CAUTION:**

Risk of explosion if battery is replaced by an incorrect type. Only certified engineers should replace the on-board battery.

Dispose of used batteries according to instructions and local regulations.

- Outside the European Union – If you wish to dispose of used electrical and electronic products outside the European Union, please contact your local authority so as to comply with the correct disposal method.
- Within the European Union – The device that produces less waste and is easier to recycle is classified as electronic device in terms of the European Directive 2012/19/EU (WEEE), and must not be disposed of as domestic garbage.

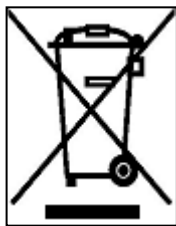

EU-wide legislation, as implemented in each Member State, requires that waste electrical and electronic products carrying the mark (left) must be disposed of separately from normal household waste. This includes monitors and electrical accessories, such as signal cables or power cords.

When you need to dispose of your display products, please follow the guidance of your local authority, or ask the shop where you purchased the product. The mark on electrical and electronic products only applies to the current European Union Member States.

Please follow the national guidelines for electrical and electronic product disposal.

B.2 Maintenance and Cleaning Precautions

When maintaining or cleaning the LCD-KIT-F, please follow the guidelines below.



WARNING:

- For safety reasons, turn-off the power and unplug the panel PC before cleaning.
 - If you dropped any material or liquid such as water onto the panel PC when cleaning, unplug the power cable immediately and contact your dealer or the nearest service center. Always make sure your hands are dry when unplugging the power cable.
-

B.2.1 Maintenance and Cleaning

Prior to cleaning any part or component of the LCD-KIT-F, please read the details below.

- Except for the LCD panel, never spray or squirt liquids directly onto any other components. To clean the LCD panel, gently wipe it with a piece of soft dry cloth or a slightly moistened cloth.
- The interior of the device does not require cleaning. Keep fluids away from the device interior.
- Be cautious of all small removable components when vacuuming the device.
- Never drop any objects or liquids through the openings of the device.
- Be cautious of any possible allergic reactions to solvents or chemicals used when cleaning the device.
- Avoid eating, drinking and smoking within vicinity of the device.

B.2.2 Cleaning Tools

Some components in the LCD-KIT-F may only be cleaned using a product specifically designed for the purpose. In such case, the product will be explicitly mentioned in the cleaning tips. Below is a list of items to use when cleaning the LCD-KIT-F.

- **Cloth** – Although paper towels or tissues can be used, a soft, clean piece of cloth is recommended when cleaning the device.
- **Water or rubbing alcohol** – A cloth moistened with water or rubbing alcohol

LCD-KIT-F

can be used to clean the device.

- **Using solvents** – The use of solvents is not recommended when cleaning the device as they may damage the plastic parts.
- **Vacuum cleaner** – Using a vacuum specifically designed for computers is one of the best methods of cleaning the device. Dust and dirt can restrict the airflow in the device and cause its circuitry to corrode.
- **Cotton swabs** – Cotton swabs moistened with rubbing alcohol or water are excellent tools for wiping hard to reach areas.
- **Foam swabs** – Whenever possible, it is best to use lint free swabs such as foam swabs for cleaning.

Appendix

C

smartOSD

LCD-KIT-F

C.1 IEI smartOSD Quick Installation Guide

IEI smartOSD is a proprietary On-Screen-Display (OSD) software solution from IEI that enables easy, remote monitor setting adjustments in a Windows environment. IEI smartOSD delivers excellent performance and provides more flexibility than the typical OSD hardware solutions when adjusting a monitor. smartOSD also allows monitor settings such as brightness, contrast, screen position, size, color gain to be read and changed over normal video cable (VGA or DVI).

C.2 Pre-installation Notice

Before installing smartOSD software, please make sure one of the following operating systems is installed:

- Windows 95
- Windows NT 4.0
- Windows 98
- Windows 2000
- Windows 2003
- Windows XP
- Windows Vista
- Windows 7

C.3 smartOSD Installation

Connect the LCD-KIT-F to a host computer. Insert the CD that came with the system and follow the instructions below.

Step 1: Insert the CD into a CD drive connected to the system.

Step 2: Locate the setup file and double click on it.

Step 3: The welcome screen shown in Figure C-1 appears.

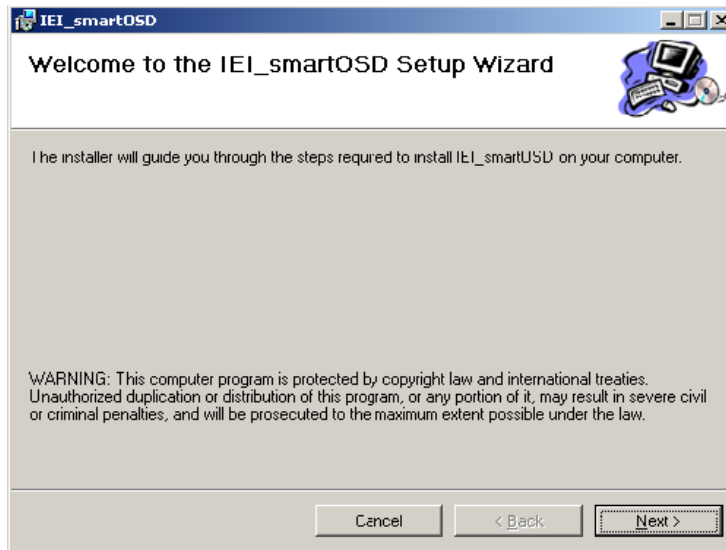

Figure C-1: smartOSD Welcome Screen

Step 4: Click **Next** to continue.

Step 5: The Folder Select screen in **Figure C-2** appears.

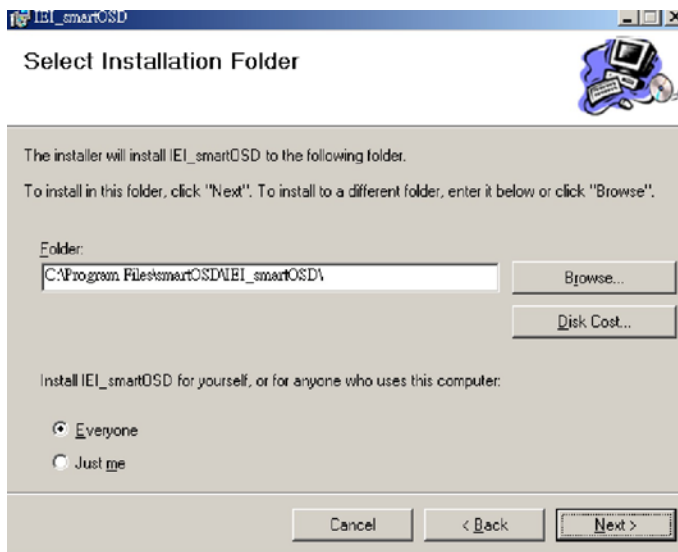

Figure C-2: smartOSD Folder Select Screen

Step 6: Select the installation folder in Figure C-2 shown above.

Step 7: Click **Next** to continue.

Step 8: The screen in Figure C-3 appears.

LCD-KIT-F

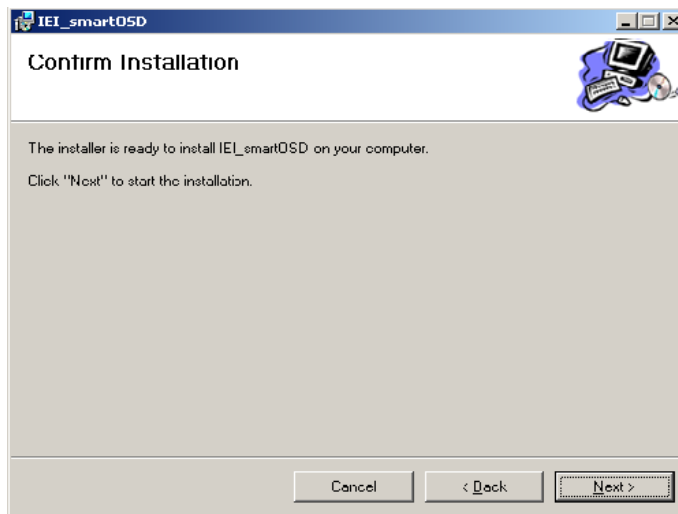

Figure C-3: smartOSD Confirm Installation

Step 9: Confirm the installation by clicking **Next** in the screen above.

Step 10: The program starts to install and the progress bar shown in Figure C-4 appears.

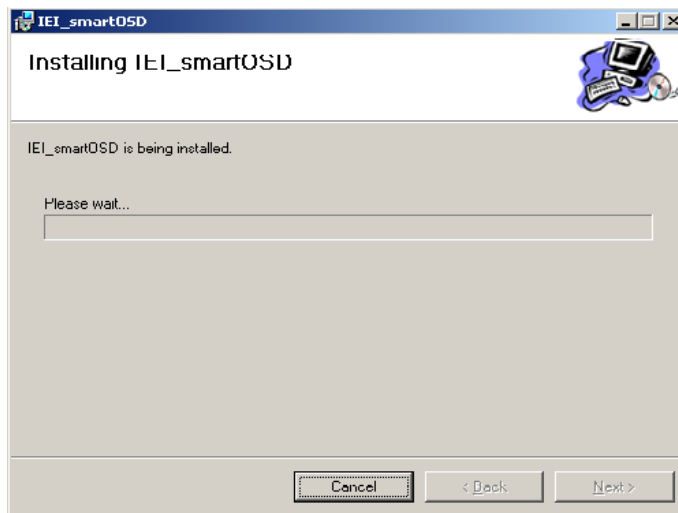

Figure C-4: smartOSD Installation Progress

Step 11: When the installation is complete the "Complete Installation" screen in

Figure C-5 appears.

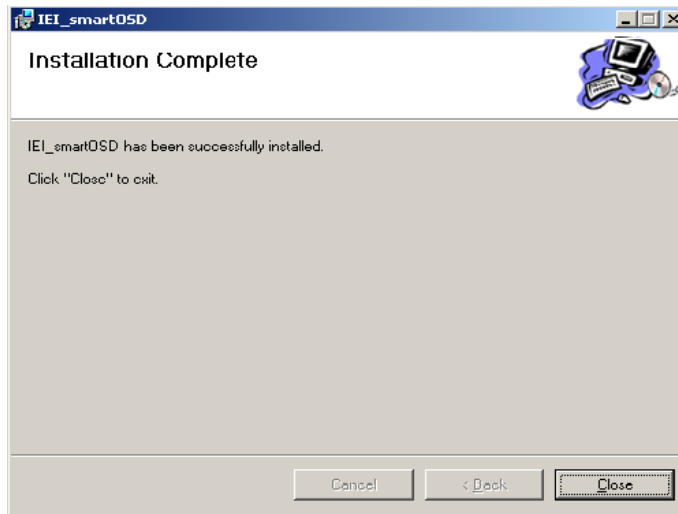
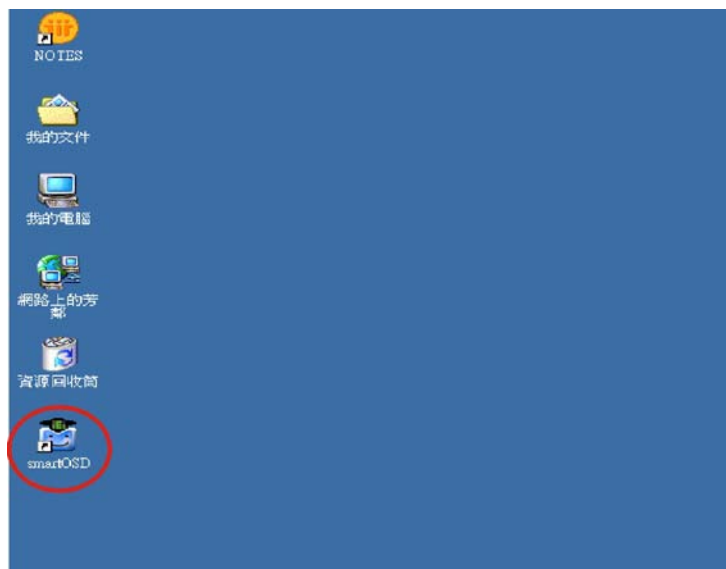

Figure C-5: smartOSD Installation Complete

Step 12: Click **Close** in the screen above.

Step 13: After quick setup is complete, the IEI smartOSD wizard logo appears on the desktop as shown in the screen below.

Step 14: To access the smartOSD, click the smartOSD wizard logo.



C.4 Software Illustration

The table below shows the smartOSD menu structure for all IEI LCD monitors.



NOTE:

To update the display setting status immediately, push the refresh button on every page

To turn the system on, press ALT + P.

Item	Elements
Management	Save/Load File
	Power Management
EDID	EDID contains basic information about the monitor and its capabilities.
Image	Brightness
	Contrast
	Sharpness
Display	Auto Adjust
	Phase
	Clock
Color	Auto Color
	User Red Gain
	User Green Gain
	User Blue Gain
	Color Temperature
	Gamma (disabled in the DM-F Series)
PIP	PIP (disabled in the DM-F Series)
	PIP Source Input (disabled in the DM-F Series)
	PIP Size (disabled in the DM-F Series)
System	Monitor Power Control

	Auto Brightness (disabled in the DM-F Series)
	Main Source Input (YPbPr, S-Video and CVBS disabled)
	Volume (disabled in the DM-F Series)
	Factory Presets/OSD Lock/OSD Unlock
	Mute (disabled in the DM-F Series)

Table C-1: SmartOSD Menu Structure

LCD-KIT-F

C.4.1 Manage Page

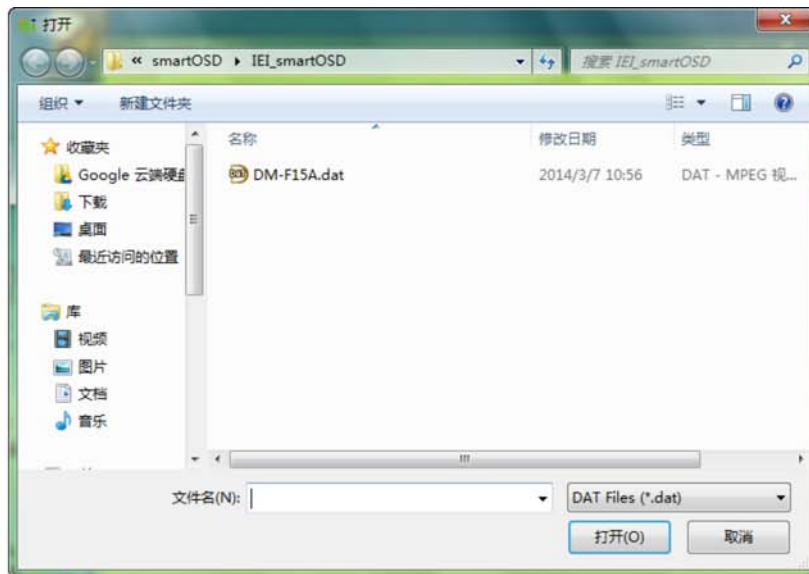

Save the preferred settings of all the OSD functions as .dat files and load the settings.

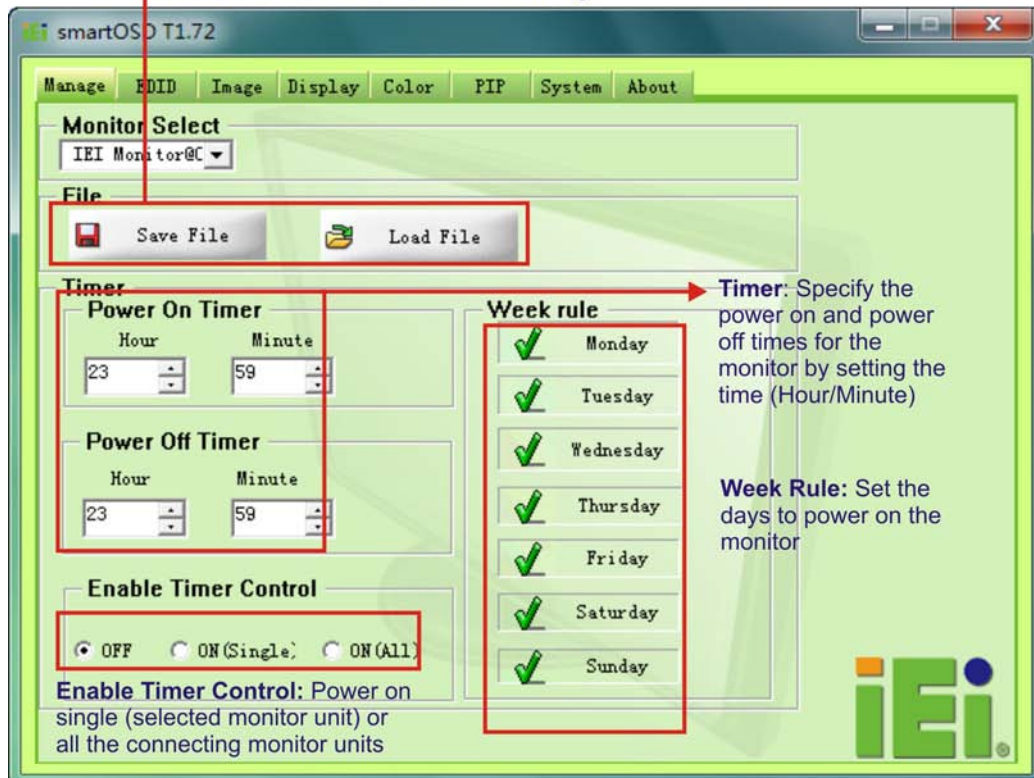

Figure C-6: Manage Page

C.4.2 EDID Page

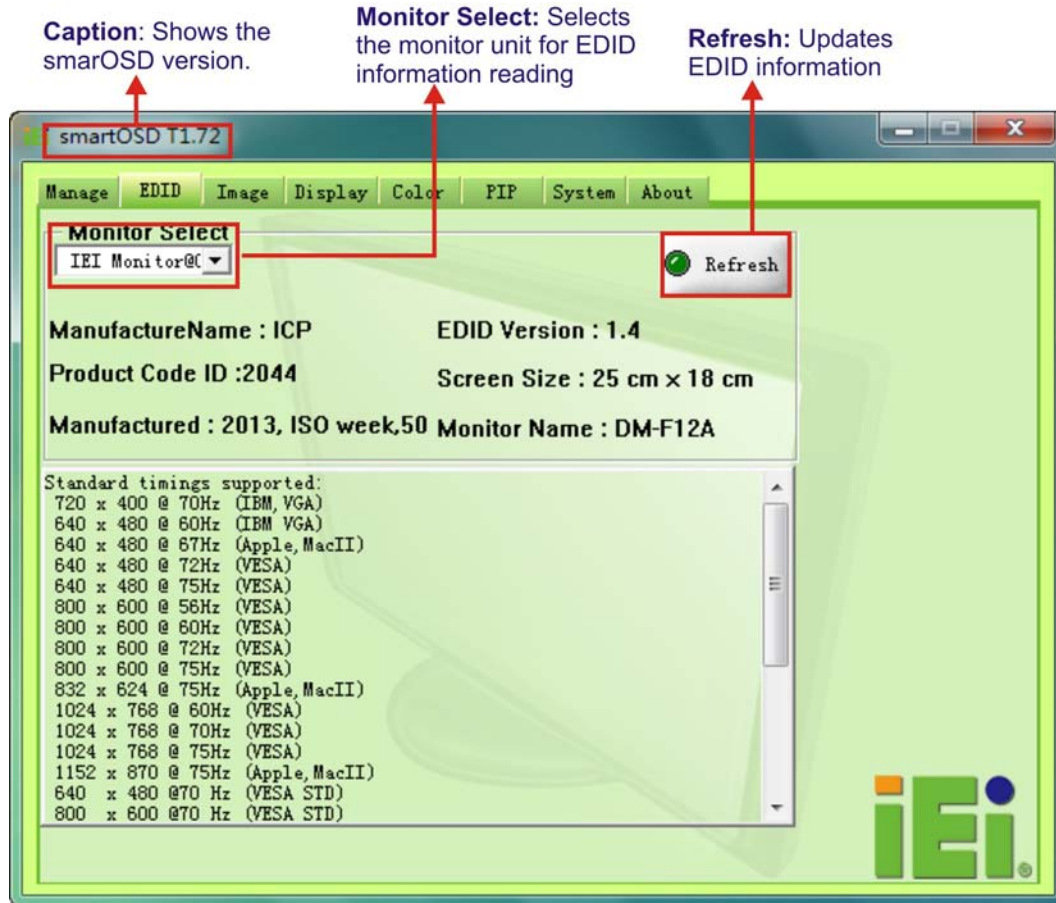

Figure C-7: EDID Page

LCD-KIT-F

C.4.3 Image Page

Monitor Select: Selects the monitor unit for which the image parameters will be adjusted

Refresh: To update image information which has been affected by the hardware OSD settings

Apply All: Delivering the image parameters settings to all the connecting monitors

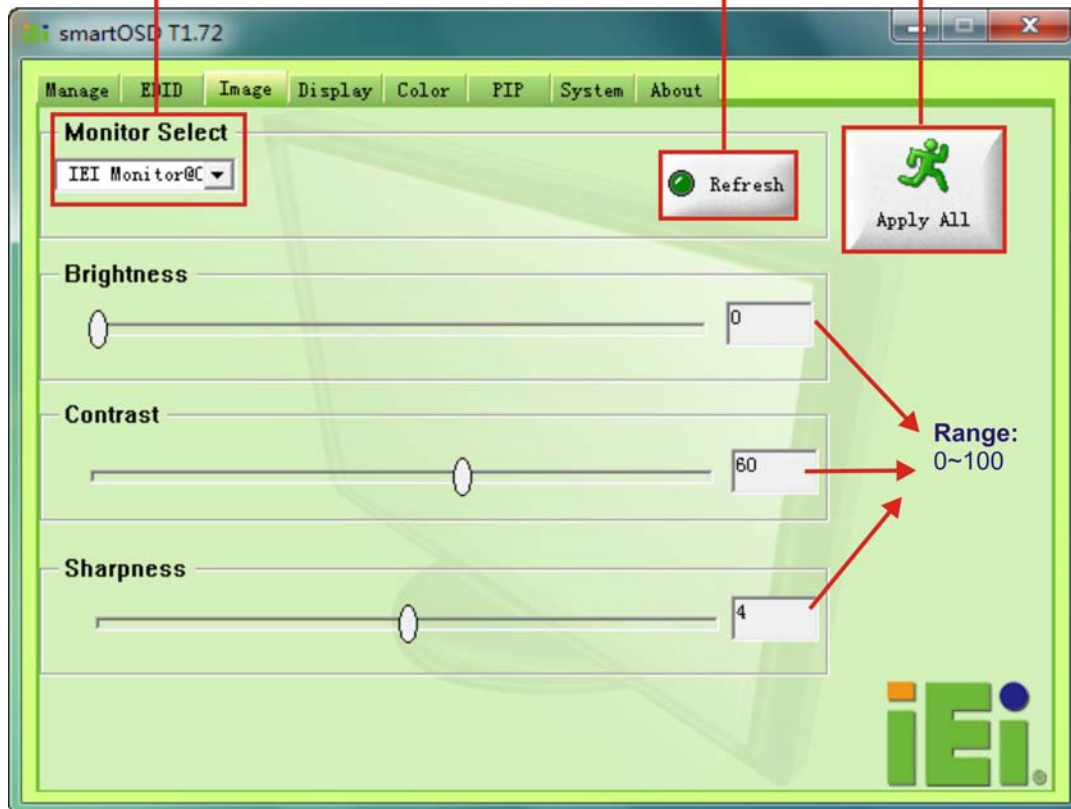

Figure C-8: Image Page

C.4.4 Display Page (for analog signal)

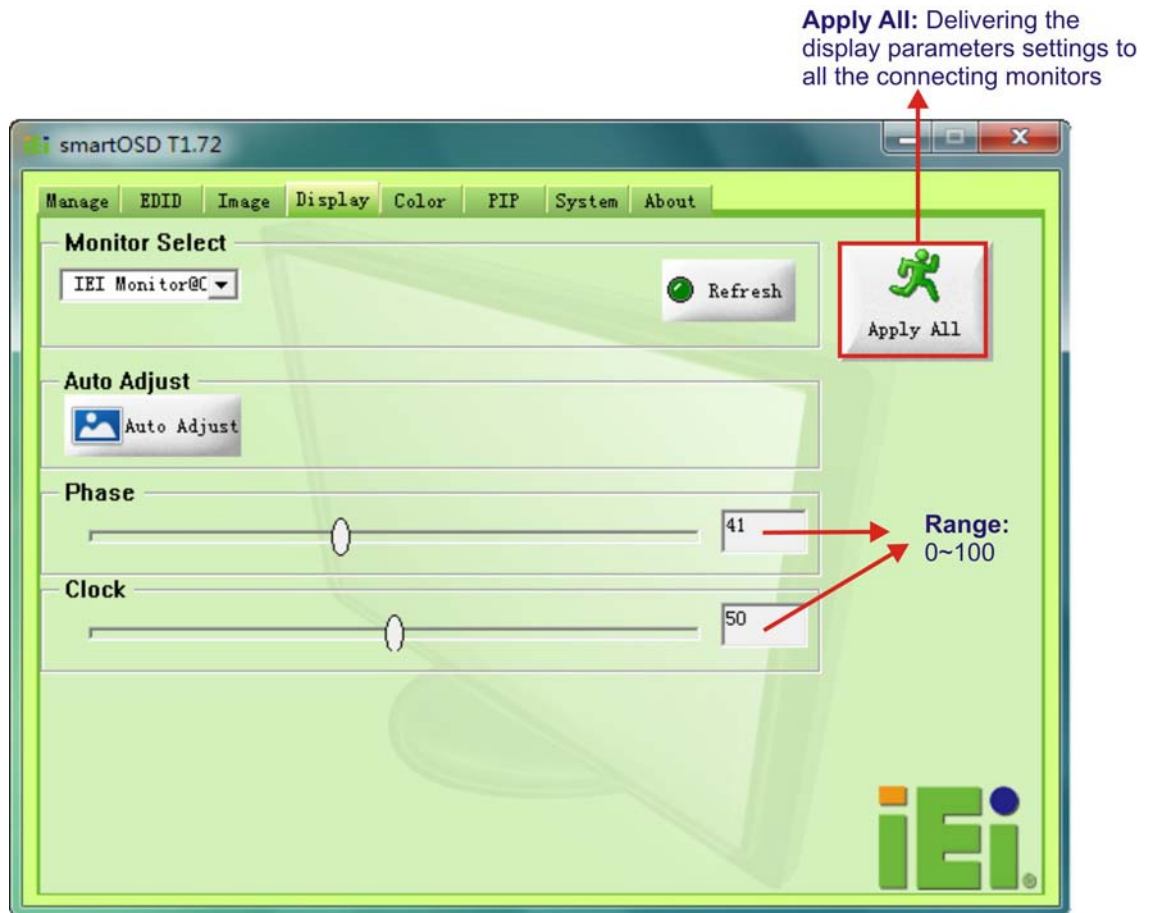

Figure C-9: Display Page

LCD-KIT-F

C.4.5 Color Page

Monitor Select: Selects the monitor unit for which the image parameters will be adjusted

Refresh: To update image information which has been affected by the color OSD settings

Apply All: Delivering the color parameters settings to all the connecting monitors

Auto Color: For analog (VGA) signal to adjust white balance

Range: 0~100 (Values can only be adjusted if user is selected for the Color Temperature)

Figure C-10: Color Page

C.4.6 PIP Page



NOTE:

The functions in the PIP page are only available in the MLCD-KIT Series and AFOLUX Series monitors.



Figure C-11: PIP Page

C.4.7 System Page

Monitor Select: Selects the monitor unit for which the system parameters will be adjusted

Apply All: Delivering the system parameter settings to all the connecting monitors

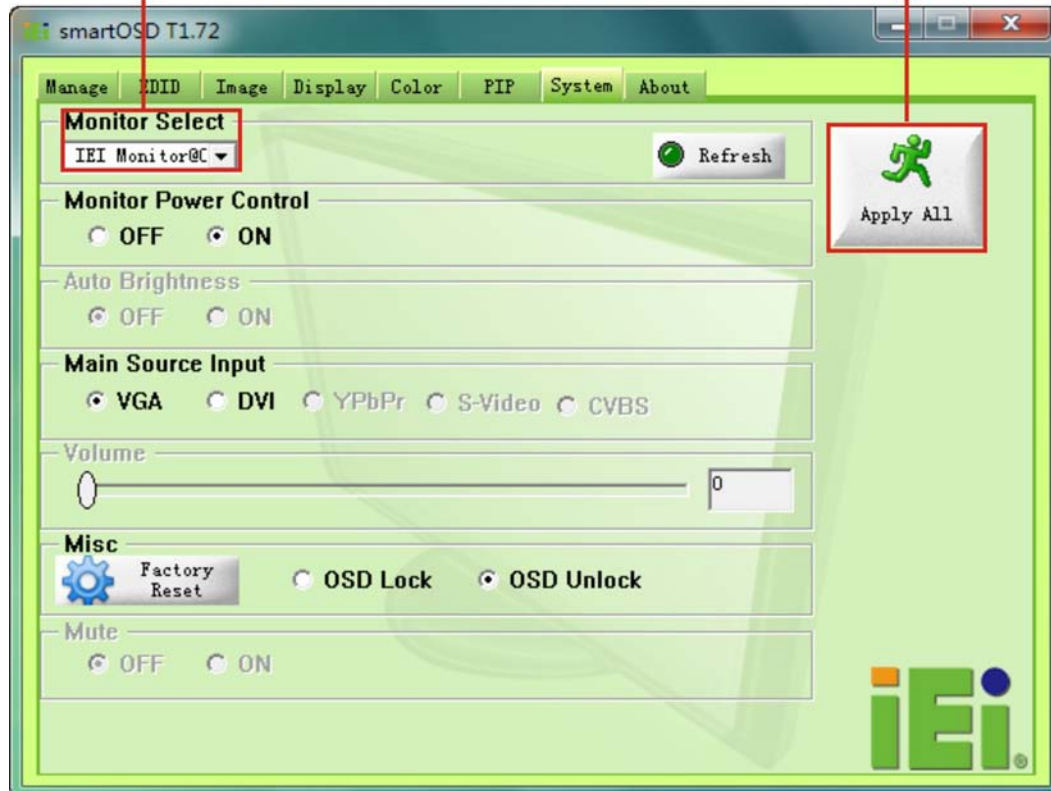

Figure C-12: System Page



NOTE:

Some of the functions in the System Page are only available to some of the IEI LCD series as following:

- Auto Brightness: SRM, MLCD-KIT and AFOLUX series only
- Main Source Input: MLCD-KIT and AFOLUX series only
- Volume: AFOLUX series only
- Mute: AFOLUX series only

C.4.8 About Page



Figure C-13: About Page

LCD-KIT-F

C.5 smartOSD FAQ

For troubleshooting, please see the steps below:

C.5.1 Windows 2000 Installation Failure

Installation fails under Windows 2000 and shows the following image:

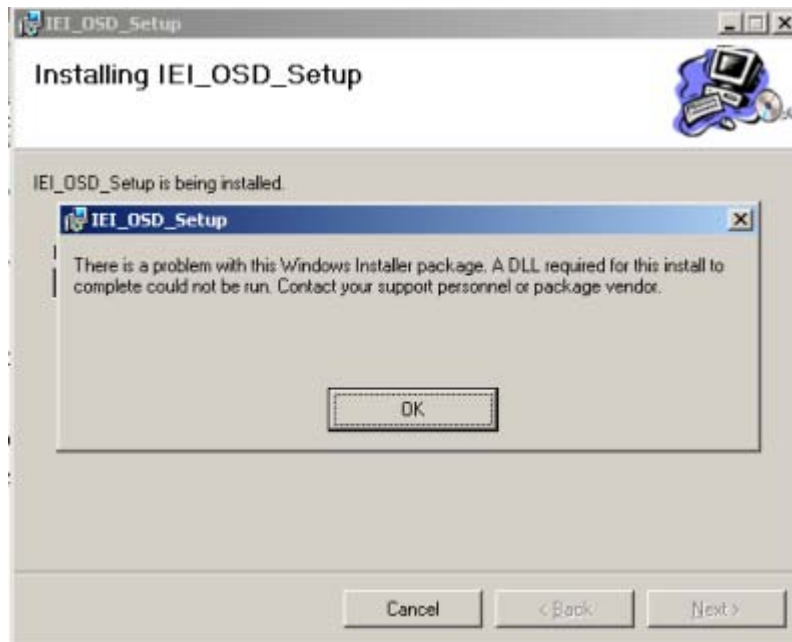

Figure C-14: DLL Missing

Solution: Download and install service pack Windows Installer 3.1

C.5.2 Vista Installation Failure

Installation fail under Vista while showing following image:



Figure C-15: Windows Vista Error

Solution: Install SmartOSD.exe as the administrator authority

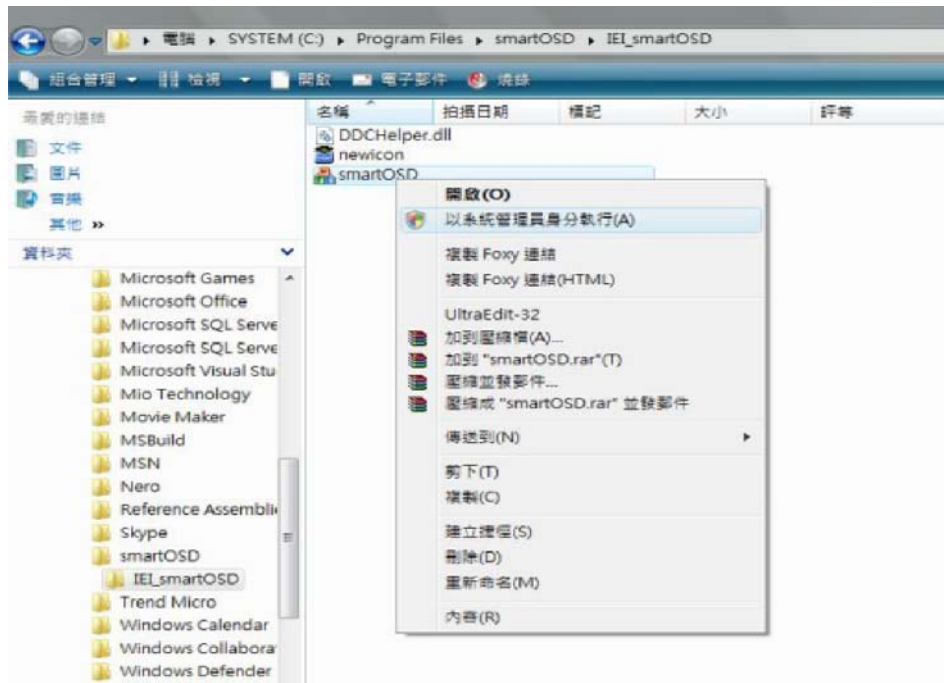

Figure C-16: Install as Administrator

C.5.3 Model Failure

The Model Fail error message shown below appears.



Figure C-17: Firmware Incompatibility

Solution: SmartOSD only supports firmware version 2.0 and following versions.

LCD-KIT-F

C.5.4 DDC Port Failure

The DDC port fail error message shown below appears.



Figure C-18: DDC Port Failure

Solutions:

- Check VGA or HDMI cable
- Check an IEI monitor is being used
- Make sure the version is version 2.3 for the AFOLUX/MDM series and version 1.5 for the DM/ISDM/TDM/SRM/LCD-KIT series that have the SmartOSD functions
- Check if the OSD control status is busy. A busy signal may cause the signal message for a short time.

Appendix

D

Hazardous Materials Disclosure

LCD-KIT-F

The details provided in this appendix are to ensure that the product is compliant with the Peoples Republic of China (China) RoHS standards. The table below acknowledges the presences of small quantities of certain materials in the product, and is applicable to China RoHS only.

A label will be placed on each product to indicate the estimated “Environmentally Friendly Use Period” (EFUP). This is an estimate of the number of years that these substances would “not leak out or undergo abrupt change.” This product may contain replaceable sub-assemblies/components which have a shorter EFUP such as batteries and lamps. These components will be separately marked.

Please refer to the following table.

Part Name	Toxic or Hazardous Substances and Elements					
	Lead (Pb)	Mercury (Hg)	Cadmium (Cd)	Hexavalent Chromium (CR(VI))	Polybrominated Biphenyls (PBB)	Polybrominated Diphenyl Ethers (PBDE)
Housing	O	O	O	O	O	O
Display	O	O	O	O	O	O
Printed Circuit Board	O	O	O	O	O	O
Metal Fasteners	O	O	O	O	O	O
Cable Assembly	O	O	O	O	O	O
Fan Assembly	O	O	O	O	O	O
Power Supply Assemblies	O	O	O	O	O	O
Battery	O	O	O	O	O	O

O: This toxic or hazardous substance is contained in all of the homogeneous materials for the part is below the limit requirement in SJ/T11363-2006 (now replaced by GB/T 26572-2011).

X: This toxic or hazardous substance is contained in at least one of the homogeneous materials for this part is above the limit requirement in SJ/T11363-2006 (now replaced by GB/T 26572-2011).

此附件旨在确保本产品符合中国 RoHS 标准。以下表格标示此产品中某有毒物质的含量符合中国 RoHS 标准规定的限量要求。

本产品上会附有“环境友好使用期限”的标签，此期限是估算这些物质“不会有泄漏或突变”的年限。本产品可能包含有较短的环境友好使用期限的可替换元件，像是电池或灯管，这些元件将会单独标示出来。

部件名称	有毒有害物质或元素					
	铅 (Pb)	汞 (Hg)	镉 (Cd)	六价铬 (CR(VI))	多溴联苯 (PBB)	多溴二苯 醚 (PBDE)
壳体	O	O	O	O	O	O
显示	O	O	O	O	O	O
印刷电路板	O	O	O	O	O	O
金属螺帽	O	O	O	O	O	O
电缆组装	O	O	O	O	O	O
风扇组装	O	O	O	O	O	O
电力供应组装	O	O	O	O	O	O
电池	O	O	O	O	O	O

O: 表示该有毒有害物质在该部件所有物质材料中的含量均在 SJ/T 11363-2006 (现由 GB/T 26572-2011 取代) 标准规定的限量要求以下。

X: 表示该有毒有害物质至少在该部件的某一均质材料中的含量超出 SJ/T 11363-2006 (现由 GB/T 26572-2011 取代) 标准规定的限量要求。