

**MODEL:
KINO-DH810**

Mini-ITX SBC supports 22nm LGA1150 socket Intel® Core™ i7/i5/i3 and Celeron® processor, DDR3, DVI-D / VGA / DP, Dual Intel® PCIe GbE, USB 3.0, SATA 6Gb/s, HD Audio and RoHS

User Manual

Revision

Date	Version	Changes
July 22, 2015	1.04	Updated Table 3-17: Serial Port Connector Pinouts
May 19, 2015	1.03	Updated Table 3-8: Display Port Connector Pinouts
December 18, 2014	1.02	Updated Table 3-17: Serial Port Connector Pinouts
May 15, 2014	1.01	Updated Section 2.3: Packing List
December 17, 2013	1.00	Initial release

Copyright

COPYRIGHT NOTICE

The information in this document is subject to change without prior notice in order to improve reliability, design and function and does not represent a commitment on the part of the manufacturer.

In no event will the manufacturer be liable for direct, indirect, special, incidental, or consequential damages arising out of the use or inability to use the product or documentation, even if advised of the possibility of such damages.

This document contains proprietary information protected by copyright. All rights are reserved. No part of this manual may be reproduced by any mechanical, electronic, or other means in any form without prior written permission of the manufacturer.

TRADEMARKS

All registered trademarks and product names mentioned herein are used for identification purposes only and may be trademarks and/or registered trademarks of their respective owners.

Manual Conventions



WARNING

Warnings appear where overlooked details may cause damage to the equipment or result in personal injury. Warnings should be taken seriously.



CAUTION

Cautionary messages should be heeded to help reduce the chance of losing data or damaging the product.



NOTE

These messages inform the reader of essential but non-critical information. These messages should be read carefully as any directions or instructions contained therein can help avoid making mistakes.



HOT SURFACE

This symbol indicates a hot surface that should not be touched without taking care.

Table of Contents

1 INTRODUCTION.....	1
1.1 INTRODUCTION.....	2
1.2 FEATURES.....	3
1.3 CONNECTORS	4
1.4 DIMENSIONS.....	5
1.5 DATA FLOW	6
1.6 TECHNICAL SPECIFICATIONS	7
2 UNPACKING	9
2.1 ANTI-STATIC PRECAUTIONS	10
2.2 UNPACKING PRECAUTIONS.....	10
2.3 PACKING LIST.....	11
2.4 OPTIONAL ITEMS	12
3 CONNECTORS	14
3.1 PERIPHERAL INTERFACE CONNECTORS.....	15
3.1.1 KINO-DH810 Layout.....	15
3.1.2 Peripheral Interface Connectors	16
3.1.3 External Interface Panel Connectors.....	17
3.2 INTERNAL PERIPHERAL CONNECTORS	17
3.2.1 AT/ATX Mode Select Switch.....	17
3.2.2 Battery Connector.....	18
3.2.3 Clear CMOS Button.....	19
3.2.4 12V DC-IN Power Connector.....	20
3.2.5 DDR3 SO-DIMM Slots	21
3.2.6 Digital I/O Connector.....	22
3.2.7 Display Port Connector.....	23
3.2.8 Fan Connector (CPU).....	24
3.2.9 Fan Connector (System)	25
3.2.10 Front Audio Connector	26
3.2.11 Front Panel Connector.....	26

3.2.12 Keyboard/Mouse Connector	27
3.2.13 LAN LED Connector.....	28
3.2.14 PCIe x1 Slot	29
3.2.15 PCIe Mini Card Slot	30
3.2.16 Power Button	31
3.2.17 SATA 6Gb/s Drive Connectors.....	31
3.2.18 SATA Power Connectors	32
3.2.19 Serial Port Connector, RS-422/485.....	33
3.2.20 Serial Port Connectors, RS-232.....	34
3.2.21 SMBUS Connector	34
3.2.22 TPM Connector.....	35
3.2.23 USB Connectors.....	36
3.3 EXTERNAL PERIPHERAL INTERFACE CONNECTOR PANEL	37
3.3.1 Audio Connector	38
3.3.2 Ethernet and USB Connectors.....	38
3.3.3 12V DC- IN Power Connector.....	40
3.3.4 RS-232 Serial Port Connectors.....	41
3.3.5 VGA and DVI Connector	42
4 INSTALLATION	44
4.1 ANTI-STATIC PRECAUTIONS	45
4.2 INSTALLATION CONSIDERATIONS.....	46
4.3 BASIC INSTALLATION	47
4.3.1 Socket LGA1150 CPU Installation	47
4.3.2 Cooling Kit Installation	50
4.3.3 SO-DIMM Installation.....	51
4.4 INTERNAL PERIPHERAL DEVICE CONNECTIONS.....	53
4.4.1 SATA Drive Connection	53
5 BIOS.....	54
5.1 INTRODUCTION.....	55
5.1.1 Starting Setup.....	55
5.1.2 Using Setup	55
5.1.3 Getting Help.....	56
5.1.4 Unable to Reboot after Configuration Changes	56

KINO-DH810

5.1.5 BIOS Menu Bar.....	56
5.2 MAIN.....	57
5.3 ADVANCED.....	58
5.3.1 ACPI Configuration.....	59
5.3.2 Trusted Computing.....	60
5.3.3 CPU Configuration.....	62
5.3.4 SATA Configuration.....	64
5.3.5 USB Configuration.....	65
5.3.6 F81866 Super IO Configuration.....	66
5.3.6.1 Serial Port n Configuration.....	67
5.3.6.1.1 Serial Port 1 Configuration.....	67
5.3.6.1.2 Serial Port 2 Configuration.....	68
5.3.6.1.3 Serial Port 3 Configuration.....	69
5.3.6.1.4 Serial Port 4 Configuration.....	69
5.3.6.1.5 Serial Port 5 Configuration.....	70
5.3.6.1.6 Serial Port 6 Configuration.....	71
5.3.7 F81866 H/W Monitor.....	72
5.3.7.1 Smart Fan Mode Configuration.....	73
5.3.8 Serial Port Console Redirection.....	76
5.3.8.1 Console Redirection Settings.....	77
5.3.9 IEI Feature.....	80
5.4 CHIPSET.....	81
5.4.1 PCH-IO Configuration.....	82
5.4.1.1 PCH Azalia Configuration.....	83
5.4.2 System Agent (SA) Configuration.....	84
5.4.2.1 Graphics Configuration.....	84
5.4.2.2 Memory Configuration.....	86
5.5 BOOT.....	87
5.6 SECURITY.....	89
5.7 EXIT.....	90
A REGULATORY COMPLIANCE.....	92
B BIOS MENU OPTIONS.....	94
C TERMINOLOGY.....	97

D DIGITAL I/O INTERFACE.....	102
D.1 INTRODUCTION.....	103
D.2 ASSEMBLY LANGUAGE SAMPLE 1.....	104
D.3 ASSEMBLY LANGUAGE SAMPLE 2.....	104
E WATCHDOG TIMER.....	105
F HAZARDOUS MATERIALS DISCLOSURE.....	108
F.1 HAZARDOUS MATERIAL DISCLOSURE TABLE FOR IPB PRODUCTS CERTIFIED AS ROHS COMPLIANT UNDER 2002/95/EC WITHOUT MERCURY	109

List of Figures

Figure 1-1: KINO-DH810.....	2
Figure 1-2: Connectors	4
Figure 1-3: KINO-DH810 Dimensions (mm)	5
Figure 1-4: Data Flow Diagram.....	6
Figure 3-1: Connector and Jumper Locations.....	15
Figure 3-2: AT/ATX Mode Select Switch Location	18
Figure 3-3: Battery Connector Location.....	19
Figure 3-4: Clear CMOS Button Location.....	20
Figure 3-5: 12V DC-IN Power Connector Location.....	21
Figure 3-6: DDR3 SO-DIMM Slot Locations	22
Figure 3-7: Digital I/O Connector Location	22
Figure 3-8: Display Port Connector Location	23
Figure 3-9: CPU Fan Connector Locations	24
Figure 3-10: System Fan Connector Location.....	25
Figure 3-11: Front Audio Connector Location.....	26
Figure 3-12: Front Panel Connector Location	27
Figure 3-13: Keyboard/Mouse Connector Location	28
Figure 3-14: LAN LED Connector Location	29
Figure 3-15: PCIe x1 Slot Location	30
Figure 3-16: PCIe Mini Card Slot Location.....	30
Figure 3-17: Power Button Location.....	31
Figure 3-18: SATA 6Gb/s Drive Connector Locations	32
Figure 3-19: SATA Power Connector Locations	32
Figure 3-20: RS-422/485 Connector Location.....	33
Figure 3-21: Serial Port Connector Location	34
Figure 3-22: SMBus Connector Location	35
Figure 3-23: TPM Connector Location.....	36
Figure 3-24: USB Connector Locations.....	37
Figure 3-25: KINO-DH810 External Peripheral Interface Connector.....	38
Figure 3-26: Audio Connector	38
Figure 3-27: LAN Connector.....	39

Figure 3-28: 12V DC-IN Power Connector	41
Figure 3-29: RS-232 Serial Port Connector	41
Figure 3-30: VGA Connector	42
Figure 4-1: Disengage the CPU Socket Load Lever.....	48
Figure 4-2: Remove Protective Cover.....	48
Figure 4-3: Insert the Socket LGA1150 CPU.....	49
Figure 4-4: Close the Socket LGA1150	50
Figure 4-5: Cooling Kit Support Bracket.....	51
Figure 4-6: SO-DIMM Installation	52
Figure 4-7: SATA Drive Cable Connection.....	53

List of Tables

Table 1-1: Technical Specifications.....	8
Table 3-1: Peripheral Interface Connectors.....	17
Table 3-2: Rear Panel Connectors.....	17
Table 3-3: AT/ATX Mode Select Switch Settings.....	18
Table 3-4: Battery Connector Pinouts.....	19
Table 3-5: Clear CMOS Button Settings.....	19
Table 3-6: 12V DC-IN Power Connector Pinouts.....	21
Table 3-7: Digital I/O Connector Pinouts.....	23
Table 3-8: Display Port Connector Pinouts.....	24
Table 3-9: CPU Fan Connector Pinouts.....	25
Table 3-10: System Fan Connector Pinouts.....	25
Table 3-11: Front Audio Connector Pinouts.....	26
Table 3-12: Front Panel Connector Pinouts.....	27
Table 3-13: Keyboard/Mouse Connector Pinouts.....	28
Table 3-14: LAN LED Connector Pinouts.....	29
Table 3-15: SATA Power Connector Pinouts.....	33
Table 3-16: RS-422/485 Connector Pinouts.....	33
Table 3-17: Serial Port Connector Pinouts.....	34
Table 3-18: SMBus Connector Pinouts.....	35
Table 3-19: TPM Connector Pinouts.....	36
Table 3-20: USB 2.0 Connector Pinouts (USB1, USB2).....	37
Table 3-21: LAN2_USB1 Connector Pinouts.....	39
Table 3-22: LAN1_USB1 Connector Pinouts.....	40
Table 3-23: 12V DC-IN Power Connector Pinouts.....	41
Table 3-24: RS-232 Serial Port Connector Pinouts (COM1, COM2).....	42
Table 3-25: VGA Connector Pinouts.....	42
Table 3-26: DVI Connector Pinouts.....	43
Table 5-1: BIOS Navigation Keys.....	56

List of BIOS Menus

BIOS Menu 1: Main	58
BIOS Menu 2: Advanced	59
BIOS Menu 3: ACPI Configuration	59
BIOS Menu 4: Trusted Computing	61
BIOS Menu 5: CPU Configuration	62
BIOS Menu 6: SATA Configuration	64
BIOS Menu 7: USB Configuration	65
BIOS Menu 8: Super IO Configuration.....	66
BIOS Menu 9: Serial Port n Configuration Menu.....	67
BIOS Menu 10: Hardware Health Configuration	72
BIOS Menu 11: FAN 1 Configuration	73
BIOS Menu 12: Serial Port Console Redirection	77
BIOS Menu 13: Console Redirection Settings.....	78
BIOS Menu 14: IEI Feature	80
BIOS Menu 15: Chipset	81
BIOS Menu 16:PCH-IO Configuration	82
BIOS Menu 17:PCH-IO Configuration	83
BIOS Menu 18: System Agent (SA) Configuration	84
BIOS Menu 19: Graphics Configuration	85
BIOS Menu 20: Memory Configuration.....	87
BIOS Menu 21: Boot	87
BIOS Menu 22: Security	89
BIOS Menu 23:Exit.....	90

Chapter

1

Introduction

1.1 Introduction

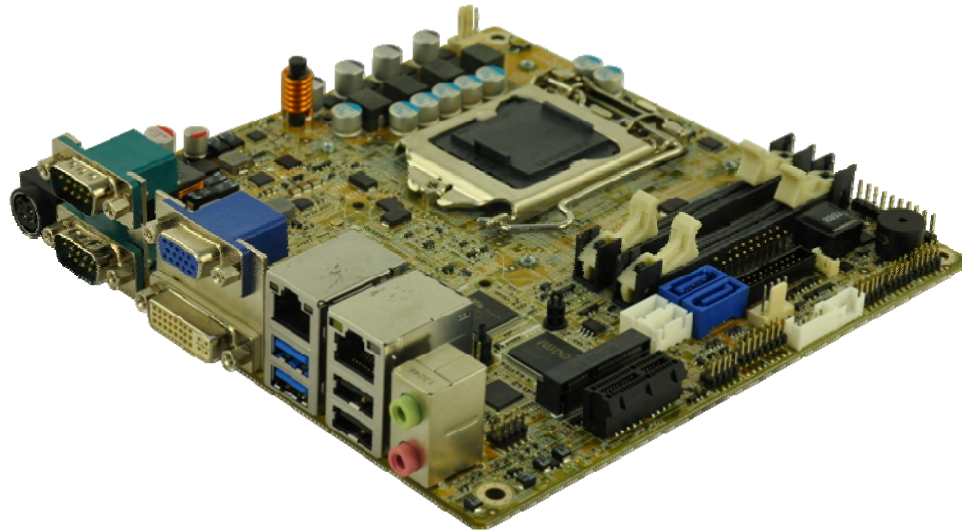

Figure 1-1: KINO-DH810

The KINO-DH810 is a Mini-ITX motherboard. It accepts a LGA1150 Intel® Core™ i7/i5/i3 and Celeron® processor and supports two 204-pin 1066/1333/1600 MHz dual-channel DDR3 SDRAM unbuffered SO-DIMM modules up to 16 GB.

The integrated Intel® H81 system chipset supports two GbE LAN ports through dual Intel® I211AT PCIe GbE controllers.

The KINO-DH810 includes one external VGA connector, one external DVI-D connector and one internal display port connector. Expansion and I/O include one PCIe x1 slot, one mini PCIe card slot, two USB 3.0 connectors on rear panel, two USB 2.0 connectors on rear panel, four USB 2.0 connectors by pin header and two SATA 6Gb/s connectors. Serial device connectivity is provided by one internal RS-422/485 connector, three internal RS-232 connectors and two external RS-232 connectors.

KINO-DH810

1.2 Features

Some of the KINO-DH810 motherboard features are listed below:

- LGA1150 Intel® Core™ i7/i5/i3 and Celeron® processor supported
- DDR3 1066/1333/1600 MHz dual channel SDRAM
- 3D micro-architecture enhancements supports for DX11.1, OCL 1.2 and OGL3.2
- Rich media acceleration for hardware decode and encode acceleration
- High speed I/O interface for USB 3.0, SATA 6Gb/s and mSATA supported
- IEI jumper-less function

1.3 Connectors

The connectors on the KINO-DH810 are shown in the figure below.

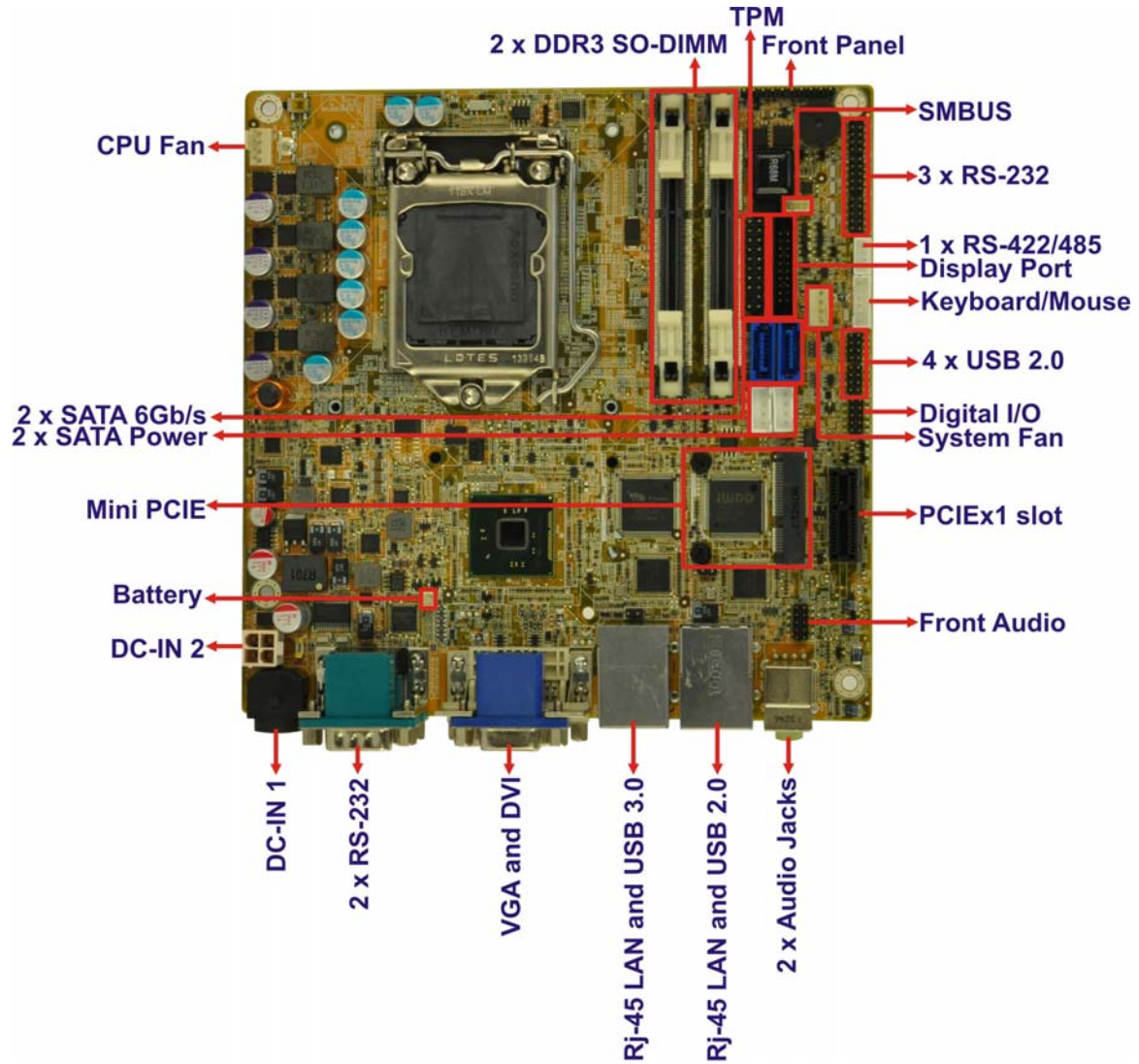

Figure 1-2: Connectors

KINO-DH810

1.4 Dimensions

The dimensions of the board are listed below:

- Length: 170 mm
- Width: 170 mm

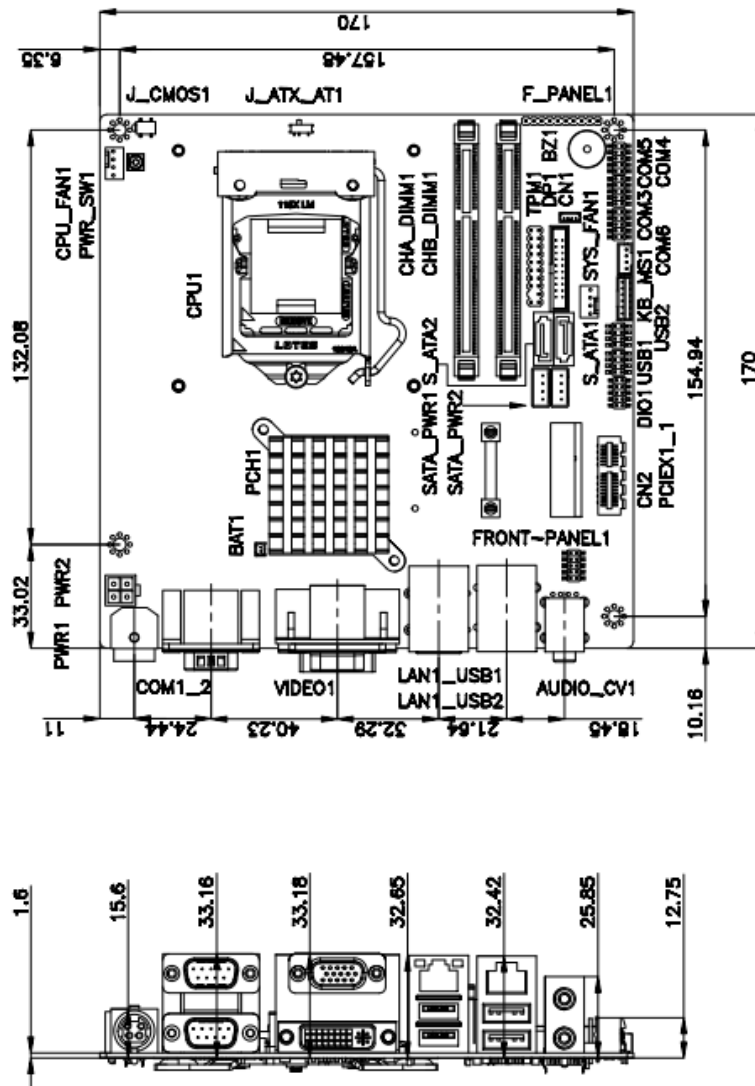

Figure 1-3: KINO-DH810 Dimensions (mm)

1.5 Data Flow

Figure 1-4 shows the data flow between the system chipset, the CPU and other components installed on the motherboard.

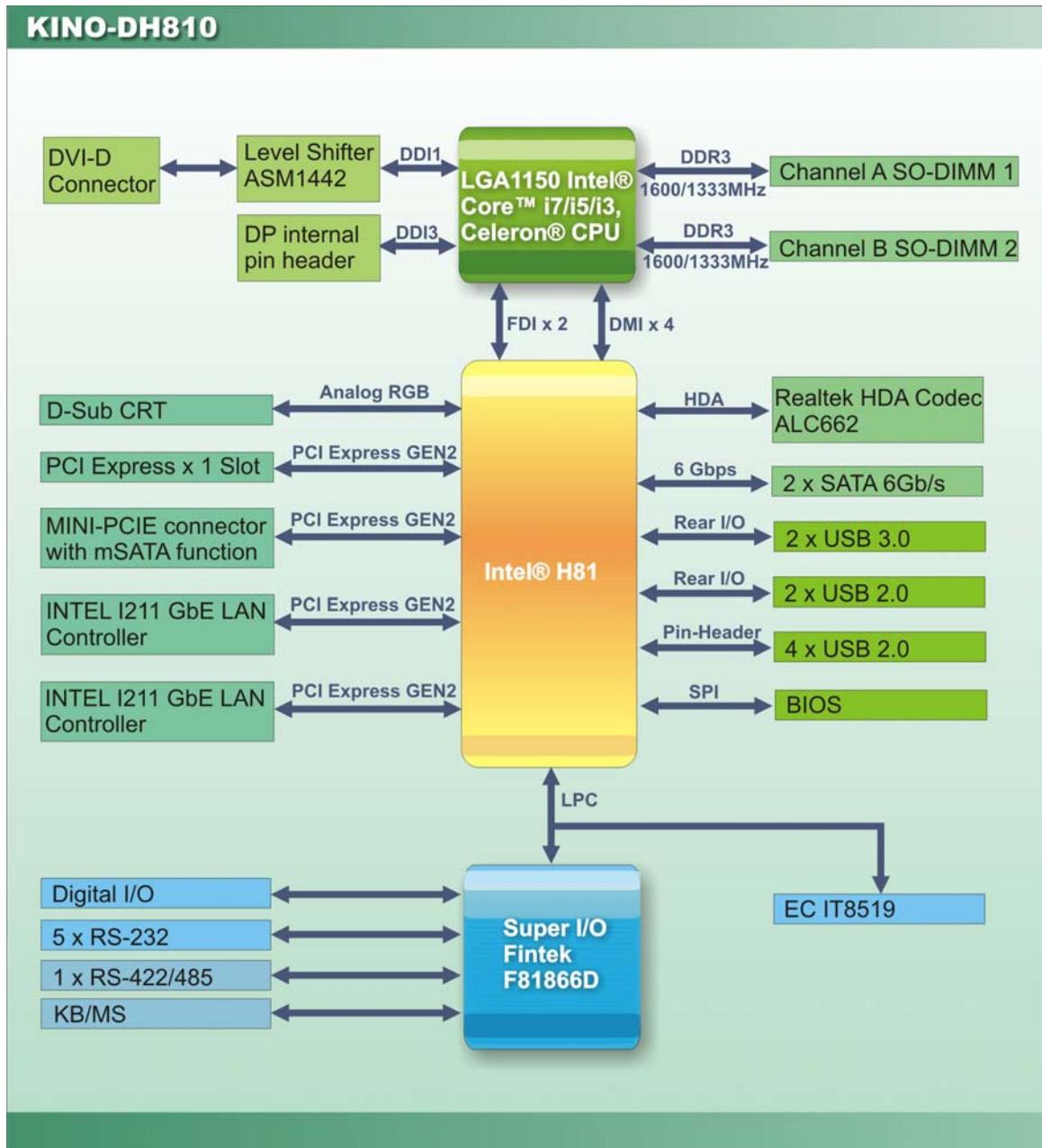

Figure 1-4: Data Flow Diagram

KINO-DH810

1.6 Technical Specifications

KINO-DH810 technical specifications are listed below.

Specification	KINO-DH810
CPU	22nm LGA1150 socket supports Intel® Core™ i7/i5/i3 and Celeron® processor
PCH	Intel® H81
Memory	Two 240-pin 1066/1333/1600 MHz dual-channel DDR3 SRAM unbuffered SO-DIMM supported (system max. 16GB)
BIOS	UEFI BIOS
Ethernet	Dual Intel I211AT PCIe GbE controller
Graphic Engine	Support for DX11.1 and OpenGL3.2 Full MPEG2, VC1, AVC Decode
Display Output	DVI-D integrated in the CPU VGA integrated in the Intel® H81 DisplayPort integrated in the CPU (pin header for changing to HDMI, LVDS, VGA, DVI, DisplayPort)
Super I/O	Fintek F81866
EC	ITE 8519
Audio	Realtek ALC662 HD Audio codec
Digital I/O	8-bit digital I/O (4-bit input, 4-bit output)
Watchdog Timer	Software programmable supports 1~255 sec. system reset
Expansions	
PCIe	1 x PCIe1 slot (with x1 signal) 1 x Mini PCIe card slot (colay mSATA)
I/O Interface Connectors	
Audio Connector	Two external audio jacks (Line-out, Mic)
Ethernet	Two RJ-45 ports
Keyboard/Mouse	1 x 6-pin wafer for PS/2 KB/MS

Specification	KINO-DH810
TPM	1 x 20-pin (2x10) header
SMBus	1 x 4-pin (1x4) wafer
Fan	1 x 4-pin (1x4) CPU fan connector 1 x 4-pin (1x4) system fan connector
Serial Ports	5 x RS-232 (2 on Rear I/O, 3 by pin header) 1 x RS-422/485 by 4-pin wafer
USB Ports	2 x USB 3.0 (on Rear I/O) 6 x USB 2.0 (2 on Rear I/O, 4 by pin header)
Front Panel	1 x Front Panel (Power LED, HDD LED, Speaker, Power Button, Reset Button)
LAN LED	2 x 2-pin (1x2) header for LAN1 LED, LAN2 LED
Storage	
Serial ATA	2 x SATA 6Gb/s without raid support
Environmental and Power Specifications	
Power Supply	DC input (12V only)
Operating Temperature	-20°C ~ 60°C
Humidity	5% ~ 95% (non-condensing)
Physical Specifications	
Dimensions	170 mm x 170 mm
Weight GW/NW	900 g / 450 g

Table 1-1: Technical Specifications

Chapter

2

Unpacking

2.1 Anti-static Precautions



WARNING!

Static electricity can destroy certain electronics. Make sure to follow the ESD precautions to prevent damage to the product, and injury to the user.

Make sure to adhere to the following guidelines:

- **Wear an anti-static wristband:** Wearing an anti-static wristband can prevent electrostatic discharge.
- **Self-grounding:** Touch a grounded conductor every few minutes to discharge any excess static buildup.
- **Use an anti-static pad:** When configuring any circuit board, place it on an anti-static mat.
- **Only handle the edges of the PCB:** Don't touch the surface of the motherboard. Hold the motherboard by the edges when handling.

2.2 Unpacking Precautions

When the KINO-DH810 is unpacked, please do the following:

- Follow the antistatic guidelines above.
- Make sure the packing box is facing upwards when opening.
- Make sure all the packing list items are present.

KINO-DH810







2.3 Packing List

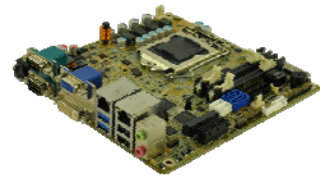

NOTE:

If any of the components listed in the checklist below are missing, do not proceed with the installation. Contact the IEI reseller or vendor the KINO-DH810 was purchased from or contact an IEI sales representative directly by sending an email to sales@ieiworld.com.

The KINO-DH810 is shipped with the following components:



Quantity	Item and Part Number	Image
1	KINO-DH810 motherboard	
2	SATA cable (P/N: 32801-000100-100-RS)	
1	I/O shielding (P/N: 45014-0023C0-00-RS)	
1	Utility CD	
1	One Key Recovery CD	
1	Quick Installation Guide	

2.4 Optional Items

The following are optional components which may be separately purchased:

Item and Part Number	Image
Dual-port USB cable with bracket (P/N: 19800-003100-200-RS)	
RS232 cable, 200mm (P/N: 19800-000300-100-RS)	
RS-422/485 cable, 200mm (P/N: 32205-003800-100-RS)	
KB/MS Y cable (P/N: 32006-001100-100-RS)	
High-performance LGA1155/LGA1156 cooler kit, 1U chassis compatible, 73W (P/N: CF-1156A-RS-R11)	
LGA1155/LGA1156 cooler kit, 1U chassis compatible, 45W (P/N: CF-1156C-RS)	
LGA1155/LGA1156 cooler kit, 1U chassis compatible, 65W (P/N: CF-1156D-RS)	

KINO-DH810

<p>High-performance LGA1155/LGA1156 cooler kit, 95W (P/N: CF-1156E-RS-R11)</p>	
<p>12V 60W power adaptor with 4-pin DIN lock, 90 ~ 264VAC input, ErP (P/N: 63040-010060-050-RS)</p>	
<p>20-pin Infineon TPM module, software management tool, firmware V3.17 (P/N: TPM-IN01-R11)</p>	

Chapter

3

Connectors

KINO-DH810

3.1 Peripheral Interface Connectors

This chapter details all the jumpers and connectors.

3.1.1 KINO-DH810 Layout

The figures below show all the connectors and jumpers.

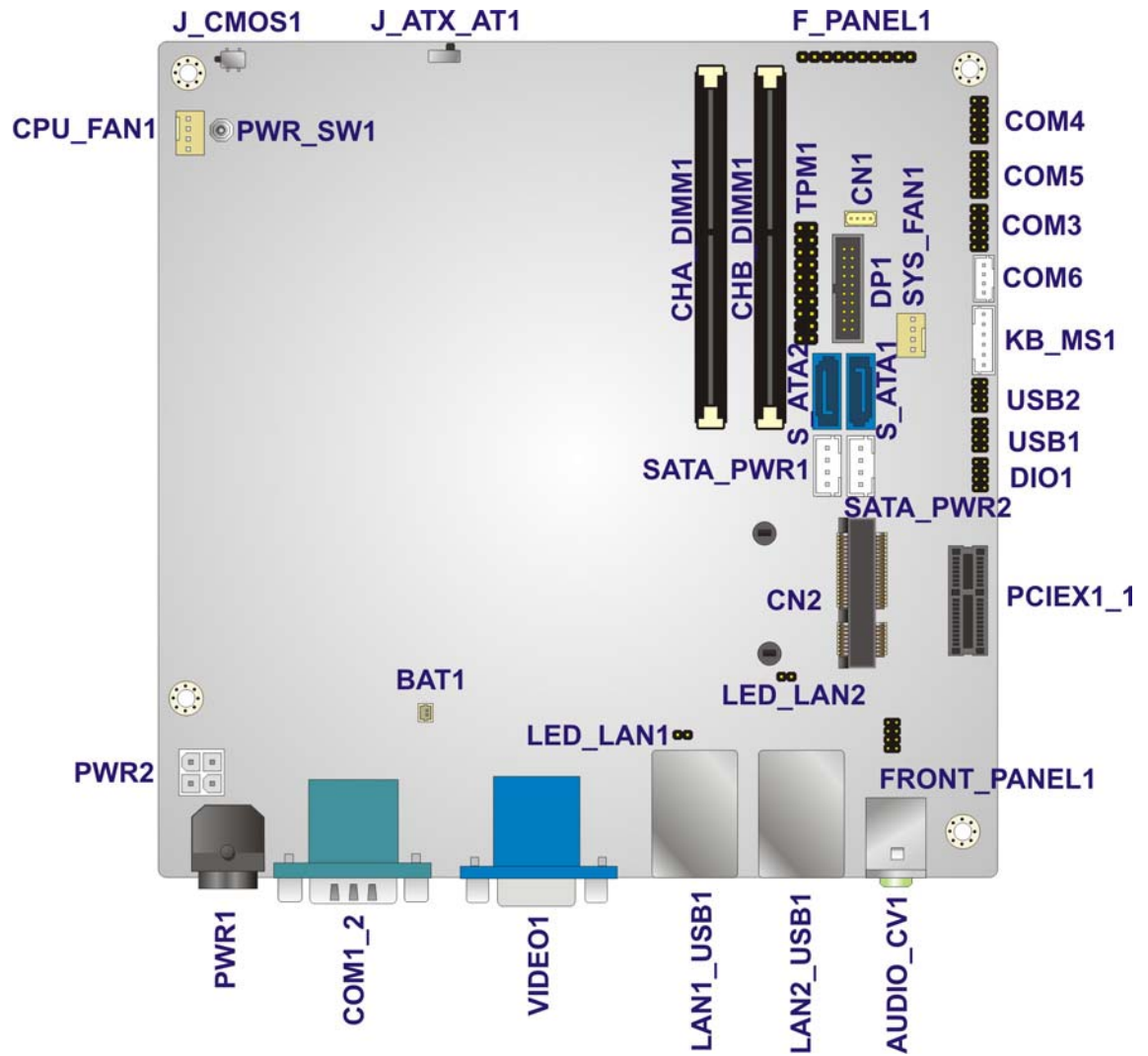

Figure 3-1: Connector and Jumper Locations

3.1.2 Peripheral Interface Connectors

The table below lists all the connectors on the board.

Connector	Type	Label
AT/ATX mode select switch	switch	J_ATX_AT1
Battery connector	2-pin wafer	BAT1
Clear CMOS button	button	J_CMOS1
12V DC-IN power connector	4-pin Molex	PWR2
DDR3 SO-DIMM slots	DDR3 SO-DIMM slot	CHA_DIMM1, CHB_DIMM1
Digital I/O connector	10-pin header	DIO1
Display port connector	20-pin box header	DP1
Fan connector (CPU)	4-pin wafer	CPU_FAN1
Fan connector (System)	4-pin wafer	SYS_FAN1
Front audio connector	10-pin header	FRONT_PANEL1
Front panel connector	10-pin header	F_PANEL1
Keyboard/Mouse connector	6-pin wafer	KB_MS1
LAN LED connector	2-pin header	LED_LAN1, LED_LAN2
PCIe x1 slot	PCIe x1 slot	PCIEX1_1
PCIe Mini card slot	PCIe Mini card slot	CN2
Power button	Push button	PWR_SW1
SATA 6Gb/s drive connectors	7-pin SATA connector	S_ATA1, S_ATA2
SATA power connectors	4-pin wafer	SATA_PWR1, SATA_PWR2
Serial port, RS-422/485	4-pin wafer	COM6
Serial port, RS-232	10-pin header	COM3, COM4, COM5

KINO-DH810

SMBus connector	4-pin wafer	CN1
TPM connector	20-pin connector	TPM1
USB connectors	8-pin header	USB1, USB2

Table 3-1: Peripheral Interface Connectors

3.1.3 External Interface Panel Connectors

The table below lists the connectors on the external I/O panel.

Connector	Type	Label
Audio connector	Audio jack	AUDIO_CV1
Ethernet and USB 3.0 connectors	RJ-45, USB 3.0	LAN1_USB1
Ethernet and USB 2.0 connectors	RJ-45, USB 2.0	LAN2_USB1
12V DC- IN power connector	4-pin Mini-DIN	PWR1
RS-232 serial port connector	DB-9 male	COM1_2
VGA and DVI connector	15-pin female, 24-pin female	VIDEO1

Table 3-2: Rear Panel Connectors

3.2 Internal Peripheral Connectors

The section describes all of the connectors on the KINO-DH810.

3.2.1 AT/ATX Mode Select Switch

CN Label:	J_ATX_AT1
CN Type:	switch
CN Settings:	See Table 3-3
CN Location:	See Figure 3-2

The AT/ATX mode select switch specifies the systems power mode as AT or ATX. AT/ATX mode select switch settings are shown in **Table 3-3**.

Setting	Description	
Short 2-3	AT Mode	
Short 1-2	ATX Mode	Default

Table 3-3: AT/ATX Mode Select Switch Settings

The location of the AT/ATX mode select switch is shown in **Figure 3-2** below.

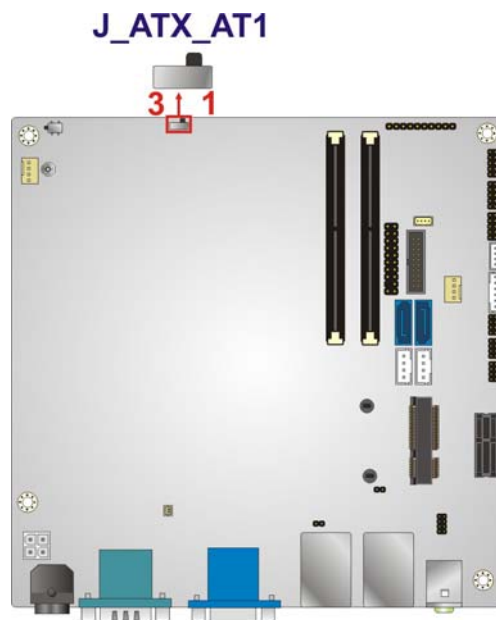

Figure 3-2: AT/ATX Mode Select Switch Location

3.2.2 Battery Connector

- CN Label:** **BAT1**
- CN Type:** 2-pin wafer
- CN Location:** See **Figure 3-3**
- CN Pinouts:** See **Table 3-4**

The battery connector is connected to the system battery. The battery provides power to the system clock to retain the time when power is turned off.

KINO-DH810

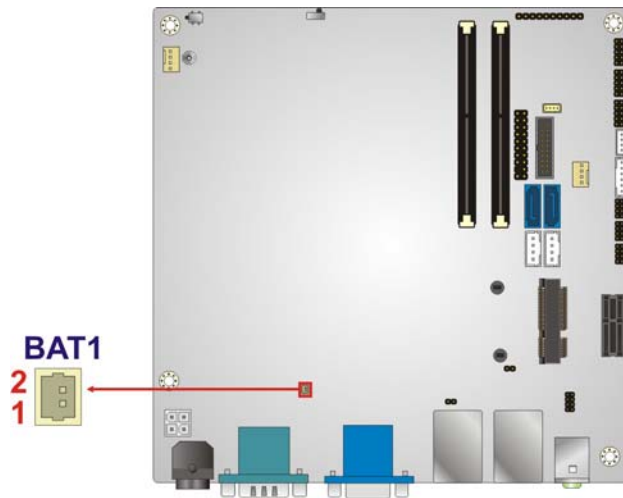

Figure 3-3: Battery Connector Location

PIN NO.	DESCRIPTION	PIN NO.	DESCRIPTION
1	VBATT	2	GND

Table 3-4: Battery Connector Pinouts

3.2.3 Clear CMOS Button

- CN Label:** J_CMOS1
- CN Type:** button
- CN Settings:** See Table 3-5
- CN Location:** See Figure 3-4

If the KINO-DH810 fails to boot due to improper BIOS settings, use the button to clear the CMOS data and reset the system BIOS information.

The clear CMOS button settings are shown in Table 3-5.

Setting	Description	
Open	Normal Operation	Default
Push	Clear CMOS Setup	

Table 3-5: Clear CMOS Button Settings

The location of the clear CMOS button is shown in Figure 3-4.

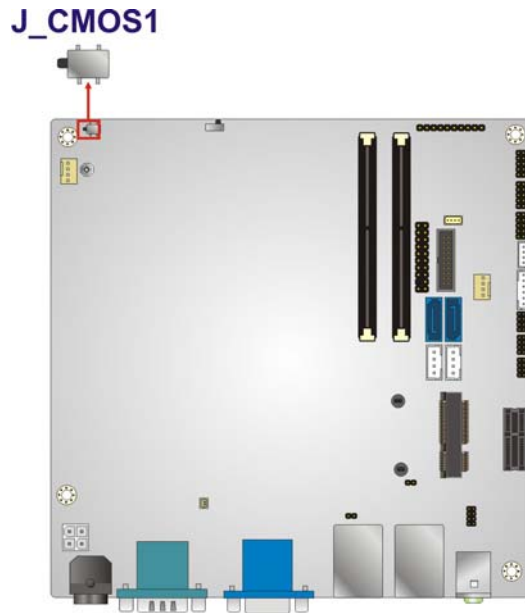

Figure 3-4: Clear CMOS Button Location

3.2.4 12V DC-IN Power Connector

- CN Label:** PWR2
- CN Type:** 4-pin Molex
- CN Location:** See **Figure 3-5**
- CN Pinouts:** See **Table 3-6**

The connector supports the 12V power supply.

KINO-DH810

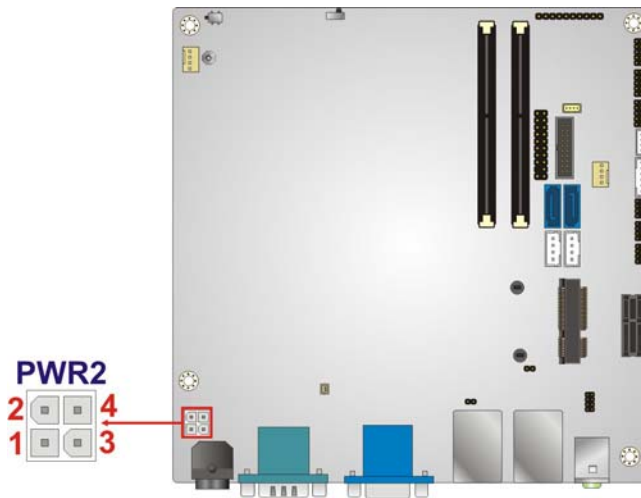

Figure 3-5: 12V DC-IN Power Connector Location

PIN NO.	DESCRIPTION	PIN NO.	DESCRIPTION
1	GND	2	GND
3	+12V	4	+12V

Table 3-6: 12V DC-IN Power Connector Pinouts

3.2.5 DDR3 SO-DIMM Slots

CN Label: CHA_DIMM1, CHB_DIMM1

CN Type: DDR3 SO-DIMM slot

CN Location: See Figure 3-6

The DDR3 SO-DIMM slots are for DDR3 SO-DIMM memory modules.

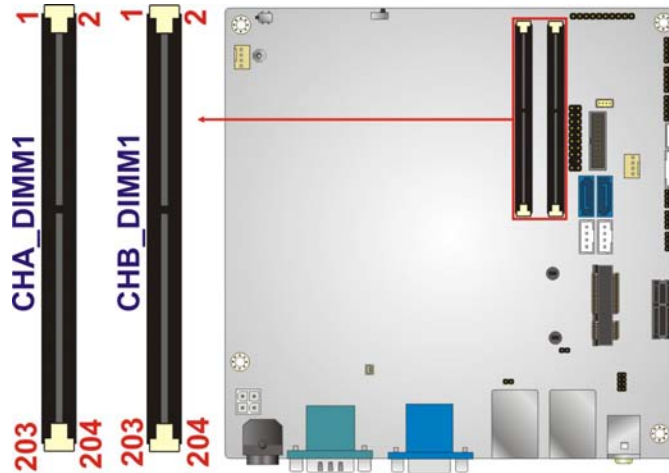

Figure 3-6: DDR3 SO-DIMM Slot Locations

3.2.6 Digital I/O Connector

CN Label:	DIO1
CN Type:	10-pin header
CN Location:	See Figure 3-7
CN Pinouts:	See Table 3-7

The digital I/O connector provides programmable input and output for external devices. The digital I/O provides 4-bit output and 4-bit input.

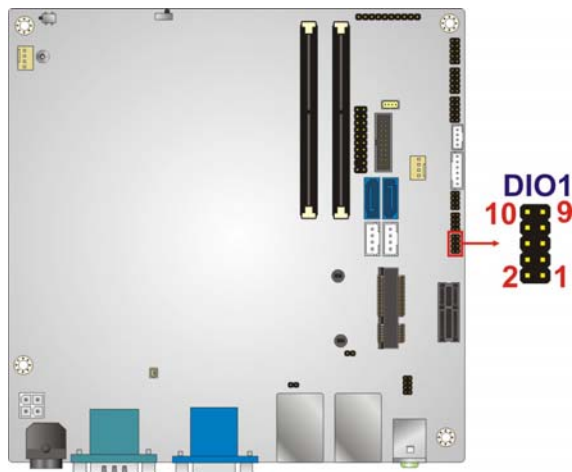

Figure 3-7: Digital I/O Connector Location

KINO-DH810

PIN NO.	DESCRIPTION	PIN NO.	DESCRIPTION
1	GND	2	+5V
3	DGPO3	4	DGPO2
5	DGPO1	6	DGPO0
7	DGPI3	8	DGPI2
9	DGPI1	10	DGPI0

Table 3-7: Digital I/O Connector Pinouts

3.2.7 Display Port Connector

- CN Label:** DP1
- CN Type:** 20-pin box header
- CN Location:** See **Figure 3-8**
- CN Pinouts:** See **Table 3-8**

The display port connector provides flexible display function that supports VGA, DVI, LVDS, HDMI and DisplayPort via the display port convert board.

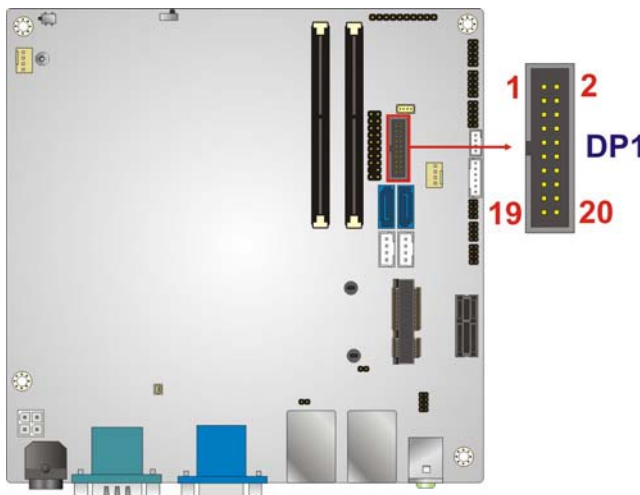

Figure 3-8: Display Port Connector Location

Pin	Description	Pin	Description
1	DDI1_HPD#	2	DPD_AUX_CTRL_P2
3	GND	4	DPD_AUX_CTRL_N2
5	AUX_CTRL_DET_D	6	GND

Pin	Description	Pin	Description
7	GND	8	DPD_OB_LANE2_P
9	DPD_OB_LANE3_P	10	DPD_OB_LANE2_N
11	DPD_OB_LANE3_N	12	GND
13	GND	14	DPD_OB_LANE0_P
15	DPD_OB_LANE1_P	16	DPD_OB_LANE0_N
17	DPD_OB_LANE1_N	18	+3.3V
19	+5V	20	NC

Table 3-8: Display Port Connector Pinouts

3.2.8 Fan Connector (CPU)

- CN Label:** CPU_FAN1
- CN Type:** 4-pin wafer
- CN Location:** See **Figure 3-9**
- CN Pinouts:** See **Table 3-9**

The fan connector attaches to a CPU cooling fan.

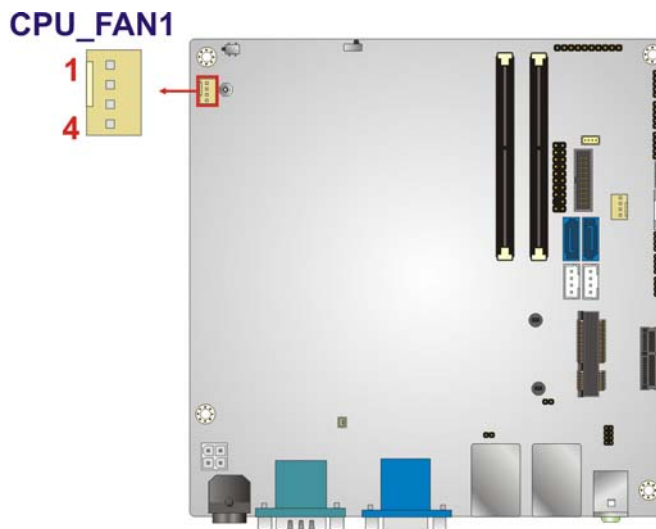

Figure 3-9: CPU Fan Connector Locations

PIN NO.	DESCRIPTION	PIN NO.	DESCRIPTION
1	GND	2	+12V

KINO-DH810

PIN NO.	DESCRIPTION	PIN NO.	DESCRIPTION
3	FANIO1	4	FANOUT1

Table 3-9: CPU Fan Connector Pinouts

3.2.9 Fan Connector (System)

- CN Label:** **SYS_FAN1**
- CN Type:** 4-pin wafer
- CN Location:** See **Figure 3-10**
- CN Pinouts:** See **Table 3-10**

The fan connector connects to a system cooling fan.

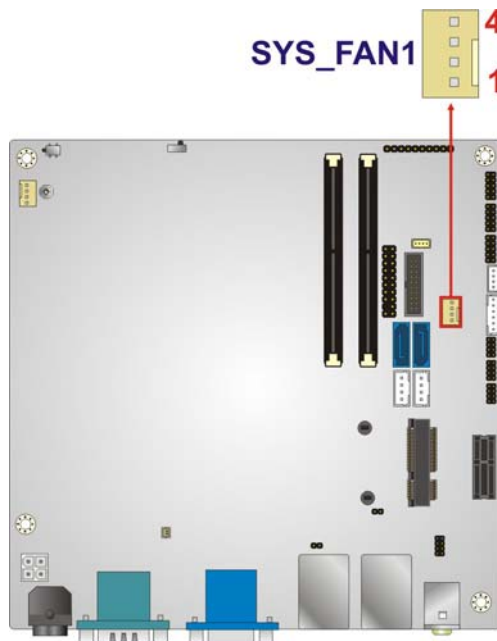

Figure 3-10: System Fan Connector Location

PIN NO.	DESCRIPTION	PIN NO.	DESCRIPTION
1	GND	2	+12V
3	FANIO2	4	FANOUT2

Table 3-10: System Fan Connector Pinouts

3.2.10 Front Audio Connector

- CN Label:** FRONT_PANEL1
- CN Type:** 10-pin header
- CN Location:** See **Figure 3-11**
- CN Pinouts:** See **Table 3-11**

This connector connects to speakers, a microphone and an audio input.

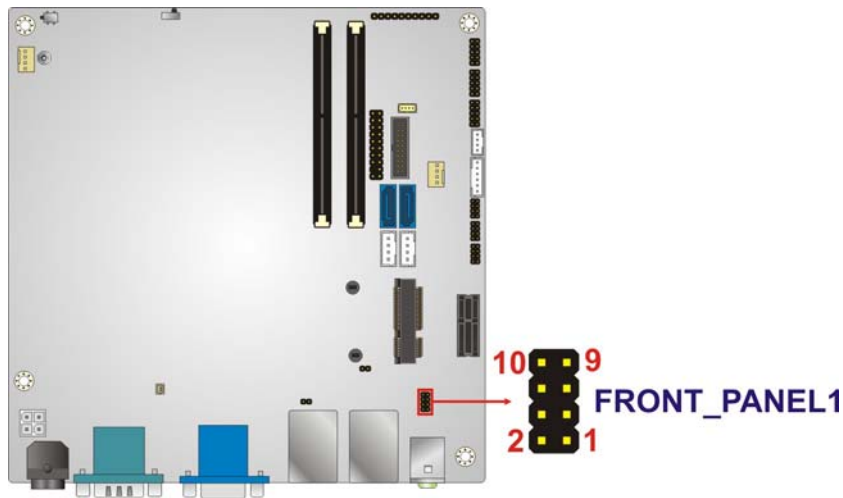

Figure 3-11: Front Audio Connector Location

Pin	Description	Pin	Description
1	MIC2-L	2	Analog_GND
3	MIC2-R	4	PRESENCE#
5	LINE2-R	6	MIC2-JD
7	FRONT-IO	8	NC
9	LINE2-L	10	LINE2-JD

Table 3-11: Front Audio Connector Pinouts

3.2.11 Front Panel Connector

- CN Label:** F_PANEL1
- CN Type:** 10-pin header

KINO-DH810

CN Location: See Figure 3-12

CN Pinouts: See Table 3-12

The front panel connector connects to the indicator LEDs and buttons on the computer's front panel.

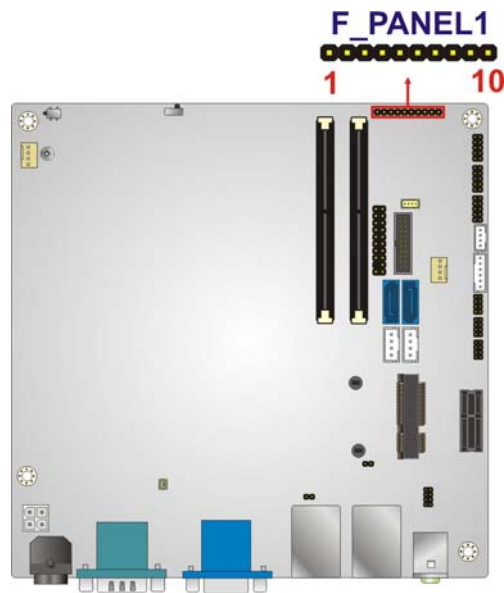

Figure 3-12: Front Panel Connector Location

PIN NO.	DESCRIPTION	PIN NO.	DESCRIPTION
1	NC	2	PWRBTN_SW
3	GND	4	HDDLED+
5	HDDLED-	6	PWRLED+
7	PWRLED+	8	GND
9	EXTRST-	10	GND

Table 3-12: Front Panel Connector Pinouts

3.2.12 Keyboard/Mouse Connector

CN Label: KB_MS1

CN Type: 6-pin wafer

CN Location: See Figure 3-13

CN Pinouts: See **Table 3-13**

The keyboard/mouse connector connects to a PS/2 Y-cable that can be connected to a PS/2 keyboard and mouse.

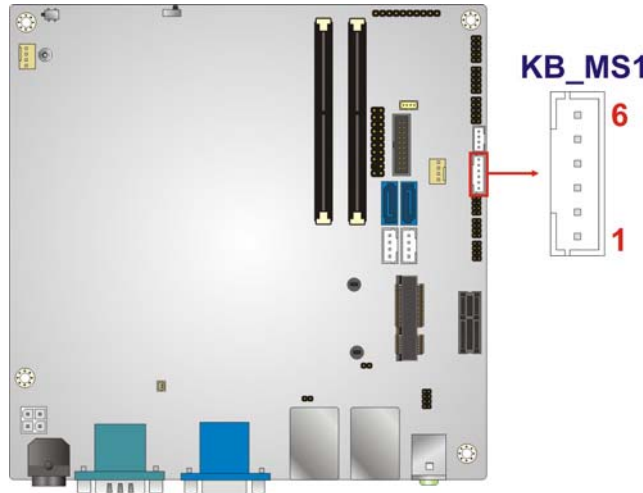

Figure 3-13: Keyboard/Mouse Connector Location

Pin	Description
1	+5V_KBMS
2	MSDATA
3	MSCLK
4	KBDATA
5	KBCLK
6	KBMS_GND

Table 3-13: Keyboard/Mouse Connector Pinouts

3.2.13 LAN LED Connector

CN Label: LED_LAN1, LED_LAN2

CN Type: 2-pin header

CN Location: See **Figure 3-14**

CN Pinouts: See **Table 3-14**

The LAN LED connectors connect to the LAN link LEDs on the system.

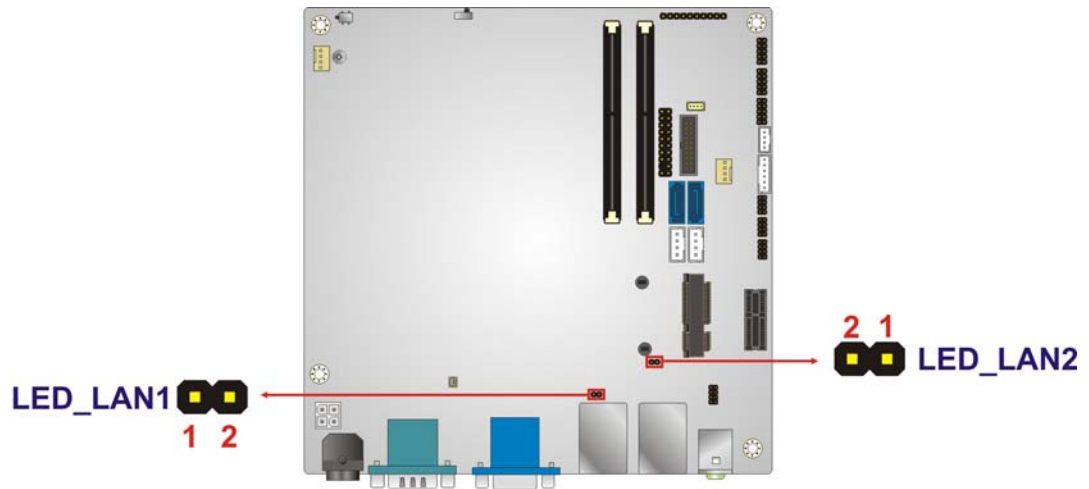

Figure 3-14: LAN LED Connector Location

PIN NO.	DESCRIPTION	PIN NO.	DESCRIPTION
1	+3.3VLAN	2	LAN1/2_LED_LINK#

Table 3-14: LAN LED Connector Pinouts

3.2.14 PCIe x1 Slot

- CN Label:** PCIEX1_1
- CN Type:** PCIe x1 slot
- CN Location:** See **Figure 3-15**

The PCIe x1 slot is for PCIe x1 expansion cards.

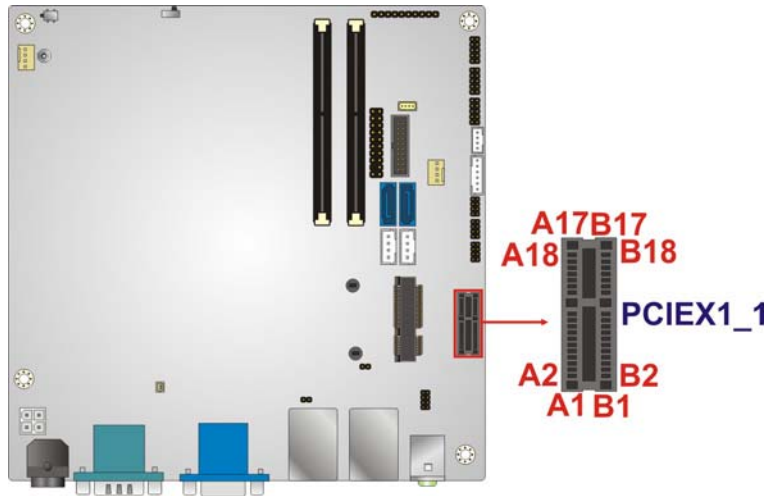

Figure 3-15: PCIe x1 Slot Location

3.2.15 PCIe Mini Card Slot

- CN Label: CN2
- CN Type: PCIe Mini card slot
- CN Location: See Figure 3-16

The PCIe Mini card slot is for installing a PCIe Mini expansion card.

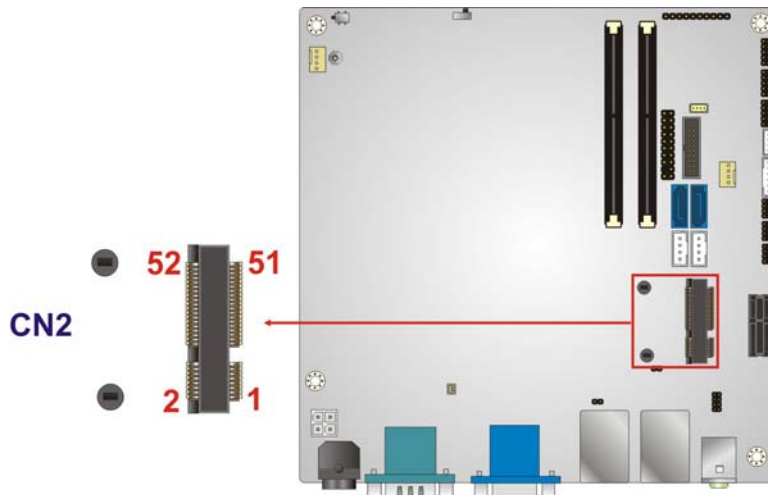

Figure 3-16: PCIe Mini Card Slot Location

KINO-DH810

3.2.16 Power Button

CN Label:	PWR_SW1
CN Type:	Push button
CN Location:	See Figure 3-17

It is an on-board power button. Push the power button to turn on the system.

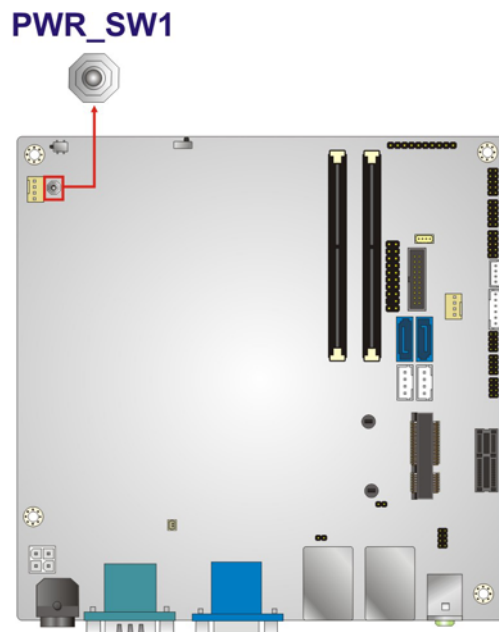

Figure 3-17: Power Button Location

3.2.17 SATA 6Gb/s Drive Connectors

CN Label:	S_ATA1, S_ATA2
CN Type:	7-pin SATA connector
CN Location:	See Figure 3-18

The two SATA 6Gb/s drive connectors are each connected to a SATA 6Gb/s drive. The SATA 6Gb/s drives transfer data at speeds as high as 6Gb/s.

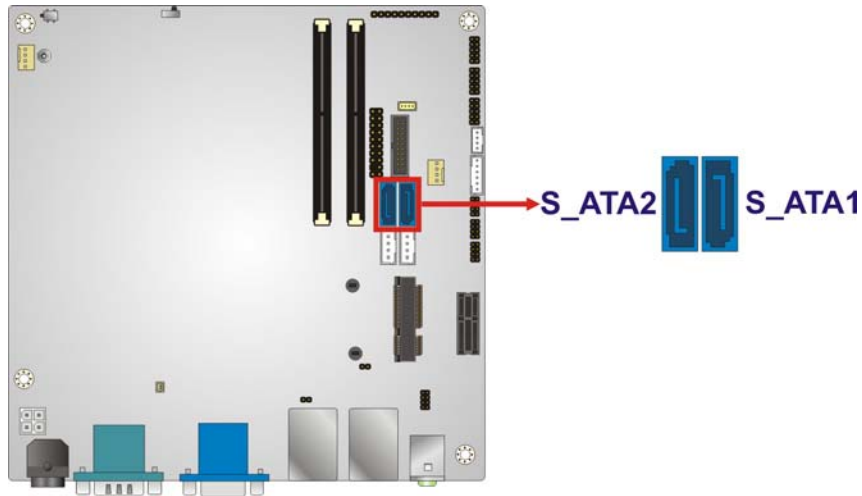

Figure 3-18: SATA 6Gb/s Drive Connector Locations

3.2.18 SATA Power Connectors

CN Label: SATA_PWR1, SATA_PWR2

CN Type: 4-pin wafer

CN Location: See **Figure 3-19**

CN Pinouts: See **Table 3-15**

Use the SATA Power Connector to connect to SATA device power connections.

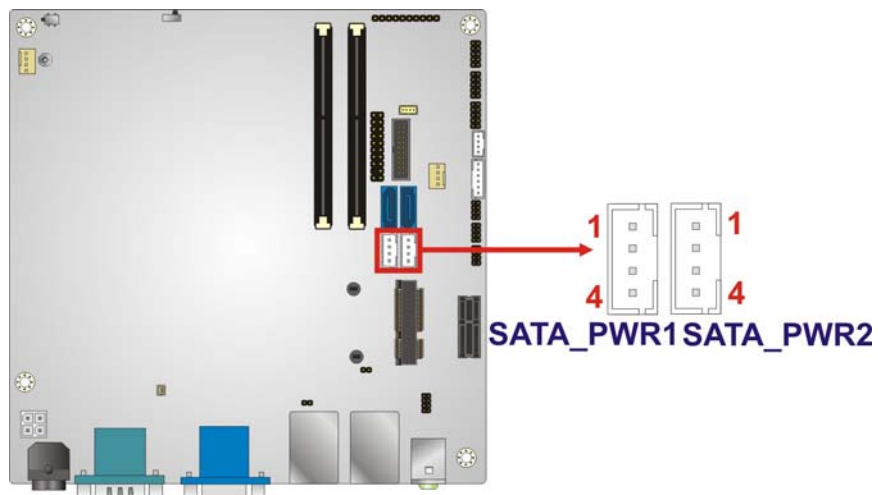

Figure 3-19: SATA Power Connector Locations

KINO-DH810

Pin	Description
1	+12V
2	GND
3	GND
4	+5V

Table 3-15: SATA Power Connector Pinouts

3.2.19 Serial Port Connector, RS-422/485

- CN Label:** COM6
- CN Type:** 4-pin wafer
- CN Location:** See **Figure 3-20**
- CN Pinouts:** See **Table 3-16**

This connector provides RS-422 or RS-485 communications.

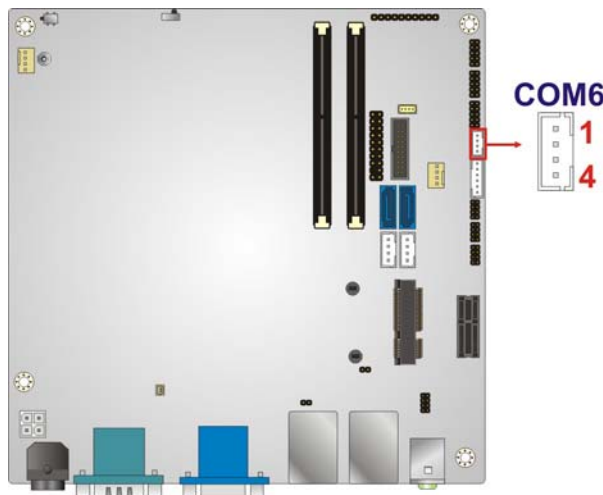

Figure 3-20: RS-422/485 Connector Location

PIN NO.	DESCRIPTION	PIN NO.	DESCRIPTION
1	RXD485#	2	RXD485+
3	TXD485+	4	TXD485#

Table 3-16: RS-422/485 Connector Pinouts

3.2.20 Serial Port Connectors, RS-232

- CN Label:** COM3, COM4, COM5
- CN Type:** 10-pin header
- CN Location:** See **Figure 3-21**
- CN Pinouts:** See **Table 3-17**

Each of these connectors provides RS-232 connections.

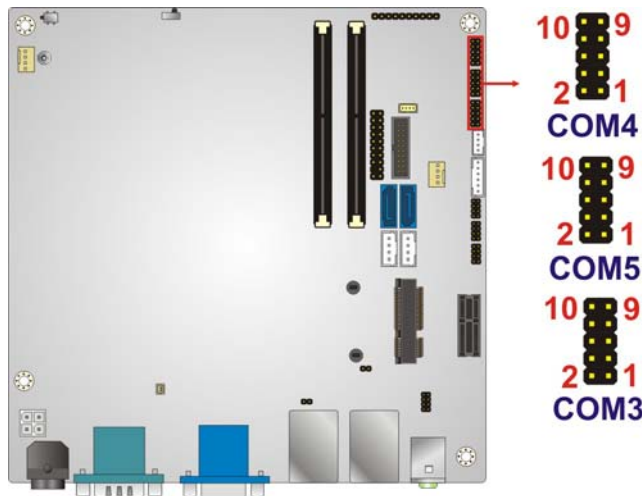

Figure 3-21: Serial Port Connector Location

PIN NO.	DESCRIPTION	PIN NO.	DESCRIPTION
1	DCD	2	DSR
3	SIN	4	RTS
5	SOUT	6	CTS
7	DTR	8	RI
9	GND	10	GND

Table 3-17: Serial Port Connector Pinouts

3.2.21 SMBUS Connector

- CN Label:** CN1
- CN Type:** 4-pin wafer
- CN Location:** See **Figure 3-22**

KINO-DH810

CN Pinouts: See **Table 3-18**

The SMBus (System Management Bus) connector provides low-speed system management communications.

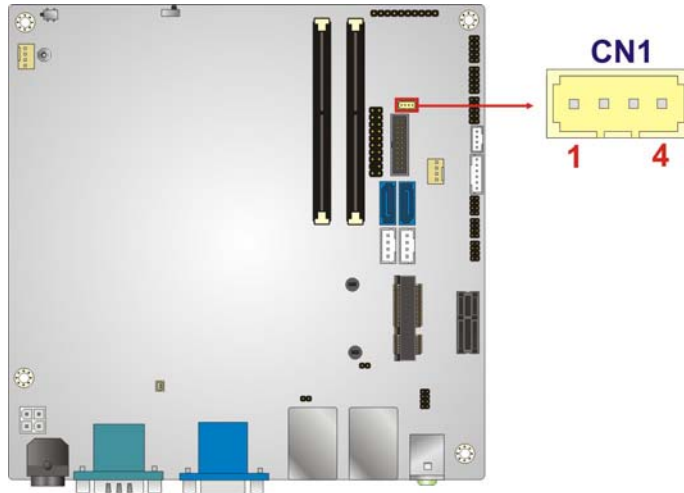

Figure 3-22: SMBus Connector Location

PIN NO.	DESCRIPTION	PIN NO.	DESCRIPTION
1	GND	2	SMBDATA
3	SMBCLK	4	+5V

Table 3-18: SMBus Connector Pinouts

3.2.22 TPM Connector

- CN Label:** TPM1
- CN Type:** 20-pin connector
- CN Location:** See **Figure 3-23**
- CN Pinouts:** See **Table 3-19**

The Trusted Platform Module (TPM) connector secures the system on bootup.

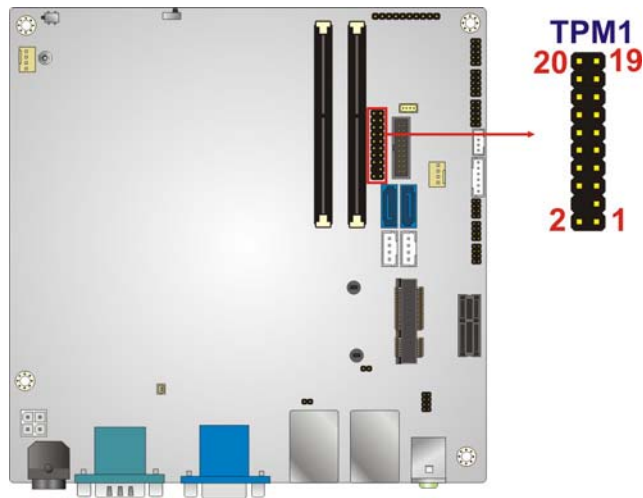

Figure 3-23: TPM Connector Location

PIN NO.	DESCRIPTION	PIN NO.	DESCRIPTION
1	TPMPCLK	2	GND
3	LPC_FRAME#	4	NC
5	BUF_PCIRST#	6	+5V
7	LPC_AD3	8	LPC_AD2
9	+3.3V	10	LPC_AD1
11	LPC_AD0	12	GND
13	SMBCLK_RESUME	14	SMBDATA_RESUME
15	+3V_DUAL	16	SERIRQ
17	GND	18	+3.3V
19	LPCPD_N	20	LDRQ0#

Table 3-19: TPM Connector Pinouts

3.2.23 USB Connectors

- CN Label:** USB1, USB2
- CN Type:** 8-pin header
- CN Location:** See **Figure 3-24**
- CN Pinouts:** See **Table 3-20**

KINO-DH810

The USB connectors connect to USB devices. Each pin header provides two USB ports.

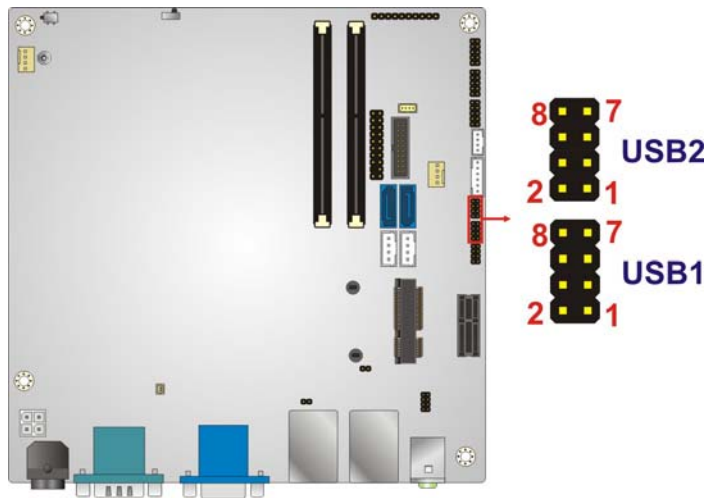

Figure 3-24: USB Connector Locations

PIN NO.	DESCRIPTION	PIN NO.	DESCRIPTION
1	+5V	2	GND
3	USB20_C_N4/8	4	USB20_C_P5/9
5	USB20_C_P4/8	6	USB20_C_N5/9
7	GND	8	+5V

Table 3-20: USB 2.0 Connector Pinouts (USB1, USB2)

3.3 External Peripheral Interface Connector Panel

Figure 3-25 shows the KINO-DH810 external peripheral interface connector (EPIC) panel.

The EPIC panel consists of the following:

- 2 x Audio jacks
- 1 x DVI connector
- 2 x Ethernet connectors
- 1 x Power connector
- 2 x RS-232 serial port connectors
- 2 x USB 2.0 connectors
- 2 x USB 3.0 connectors
- 1 x VGA connector

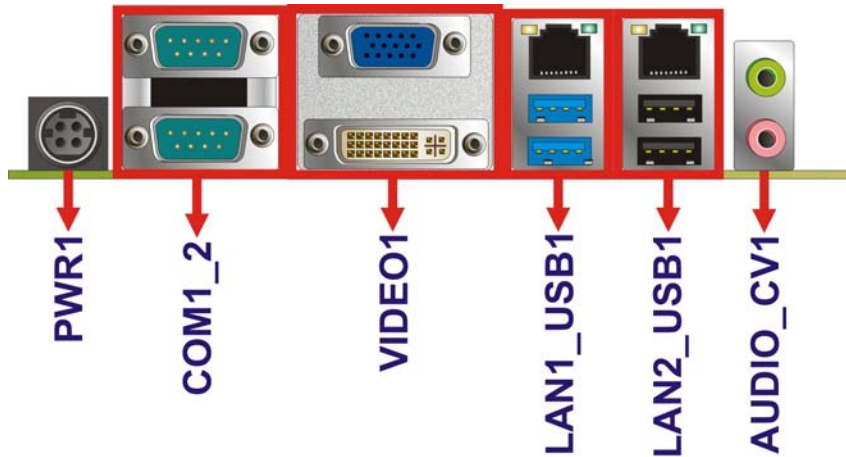

Figure 3-25: KINO-DH810 External Peripheral Interface Connector

3.3.1 Audio Connector

CN Label: AUDIO_CV1
CN Type: Audio jack
CN Location: See **Figure 3-25**

The audio jacks connect to external audio devices.

- Line Out port (Lime): Connects to a headphone or a speaker. With multi-channel configurations, this port can also connect to front speakers.
- Microphone (Pink): Connects to a microphone.



Figure 3-26: Audio Connector

3.3.2 Ethernet and USB Connectors

CN Label: LAN1_USB1, LAN2_USB1

KINO-DH810

CN Type: RJ-45 , USB 3.0 and USB 2.0 ports

CN Location: See **Figure 3-25**

CN Pinouts: See **Figure 3-27, Table 3-21 and Table 3-22**

The LAN connector connects to a local network.

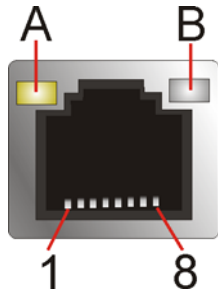

Figure 3-27: LAN Connector

The USB 2.0 ports are for attaching USB 2.0 peripheral devices to the system. The pinouts of LAN2 and USB 2.0 connectors are shown below.

PIN NO.	DESCRIPTION	PIN NO.	DESCRIPTION
P1	+1.5V_LAN2	P2	LAN2_MDIP0
P3	LAN2_MDIN0	P4	LAN2_MDIP1
P5	LAN2_MDIN1	P6	LAN2_MDIP2
P7	LAN2_MDN2	P8	LAN2_MDIP3
P9	LAN2_MDIN3	P10	GND
P11	LAN2_LINK100	P12	LAN2_LINK1000
P13	LAN2_ACT-1	P14	+V3.3A_LAN2
U1	+USB_PWR1	U2	USB20_C_N10
U3	USB20_C_P10	U4	GND
U5	+USB_PWR1	U6	USB20_C_N11
U7	USB20_C_P11	U8	GND

Table 3-21: LAN2_USB1 Connector Pinouts

The USB 3.0 ports are for attaching USB 3.0 peripheral devices to the system. To be able to use the USB 3.0 ports, please make sure the USB 3.0 driver is installed. The pinouts of LAN1 and USB 3.0 connectors are shown below.

PIN NO.	DESCRIPTION	PIN NO.	DESCRIPTION
1	USB3_PWR1	2	USB2P0_DM1
3	USB2P0_DP1	4	GND
5	USB3P0_RXDN1	6	USB3P0_RXDP1
7	GND	8	USB3P0_TXDN1
9	USB3P0_TXDP1	10	USB3_PWR2
11	USB2P0_DM2	12	USB2P0_DP2
13	GND	14	USB3P0_RXDN2
15	USB3P0_RXDP2	16	GND
17	USB3P0_TXDN2	18	USB3P0_TXDP2
19	+0.9V_LAN1	20	LAN1_MDIP0
21	LAN1_MDIN0	22	LAN1_MDIP1
23	LAN1_MDIN1	24	LAN1_MDIP2
25	LAN1_MDIN2	26	LAN1_MDIP3
27	LAN1_MDIN3	28	GND
29	+3.3V_LAN1	30	LAN1_LINK_ACT#
31	LAN1_100#	32	LAN1_1000#

Table 3-22: LAN1_USB1 Connector Pinouts

3.3.3 12V DC- IN Power Connector

CN Label: PWR1

CN Type: 4-pin Mini-DIN

CN Location: See **Figure 3-25**

CN Pinouts: See **Figure 3-28** and **Table 3-23**

The connector supports 12 V power adapter.

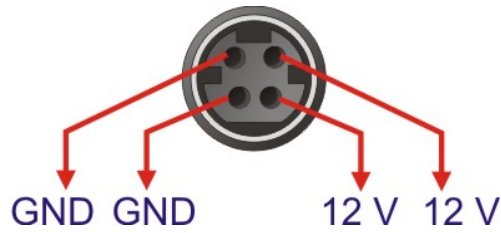

Figure 3-28: 12V DC-IN Power Connector

PIN NO.	DESCRIPTION
1	+12V
2	GND
3	+12V
4	GND
5	GND

Table 3-23: 12V DC-IN Power Connector Pinouts

3.3.4 RS-232 Serial Port Connectors

- CN Label:** COM1_2
- CN Type:** DB-9 Male
- CN Location:** See Figure 3-25
- CN Pinouts:** See Figure 3-29 and Table 3-24

The serial port connects to a RS-232 serial communications device.

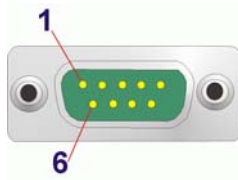

Figure 3-29: RS-232 Serial Port Connector

PIN NO.	DESCRIPTION	PIN NO.	DESCRIPTION
1	NDCD1/2#	2	NRXD1/2
3	NTXD1/2	4	NDTR1/2#
5	GND	6	NDSR1/2#

PIN NO.	DESCRIPTION	PIN NO.	DESCRIPTION
7	NRTS1/2#	8	NCTS1/2#
9	NRI1/2#		

Table 3-24: RS-232 Serial Port Connector Pinouts (COM1, COM2)

3.3.5 VGA and DVI Connector

CN Label: VIDEO1

CN Type: 15-pin female (VGA) , 24-pin female (DVI)

CN Location: See **Figure 3-25**

CN Pinouts: See **Figure 3-30** , **Table 3-25** and **Table 3-26**

The VGA port connects to a monitor that accepts a standard VGA input.

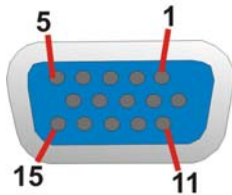

Figure 3-30: VGA Connector

PIN	DESCRIPTION	PIN	DESCRIPTION
1	Red	2	Green
3	Blue	4	NC
5	GND	6	GND
7	GND	8	GND
9	VGAVCC	10	HOTPLUG
11	NC	12	DDCDAT
13	HSYNC	14	VSYNC
15	DDCCLK		

Table 3-25: VGA Connector Pinouts

The DVI (Digital Visual Interface) port connects to a monitor that supports DVI video input.

PIN NO.	DESCRIPTION	PIN NO.	DESCRIPTION
---------	-------------	---------	-------------

KINO-DH810

PIN NO.	DESCRIPTION	PIN NO.	DESCRIPTION
1	DVI_TMDS_C_DATA2#	2	DVI_TMDS_C_DATA2
3	GND	4	NC
5	NC	6	DVI_DDC_SCLK
7	DVI_DDC_SDATA	8	NC
9	DVI_TMDS_C_DATA1#	10	DVI_TMDS_C_DATA1
11	GND	12	NC
13	NC	14	+5V_DVI
15	GND	16	DVI_HPD
17	DVI_TMDS_C_DATA0#	18	DVI_TMDS_C_DATA0
19	GND	20	NC
21	NC	22	GND
23	DVI_TMDS_C_CLK	24	DVI_TMDS_C_CLK#
C1	NC	C2	NC
C3	NC	C4	NC

Table 3-26: DVI Connector Pinouts

Chapter

4

Installation

KINO-DH810

4.1 Anti-static Precautions

**WARNING:**

Failure to take ESD precautions during the installation of the KINO-DH810 may result in permanent damage to the KINO-DH810 and severe injury to the user.

Electrostatic discharge (ESD) can cause serious damage to electronic components, including the KINO-DH810. Dry climates are especially susceptible to ESD. It is therefore critical that whenever the KINO-DH810 or any other electrical component is handled, the following anti-static precautions are strictly adhered to.

- ***Wear an anti-static wristband:*** Wearing a simple anti-static wristband can help to prevent ESD from damaging the board.
- ***Self-grounding:*** Before handling the board, touch any grounded conducting material. During the time the board is handled, frequently touch any conducting materials that are connected to the ground.
- ***Use an anti-static pad:*** When configuring the KINO-DH810, place it on an anti-static pad. This reduces the possibility of ESD damaging the KINO-DH810.
- ***Only handle the edges of the PCB:*** When handling the PCB, hold the PCB by the edges.

4.2 Installation Considerations



NOTE:

The following installation notices and installation considerations should be read and understood before the KINO-DH810 is installed. All installation notices pertaining to the installation of the KINO-DH810 should be strictly adhered to. Failing to adhere to these precautions may lead to severe damage of the KINO-DH810 and injury to the person installing the motherboard.



WARNING:

The installation instructions described in this manual should be carefully followed in order to prevent damage to the KINO-DH810, KINO-DH810 components and injury to the user.

Before and during the installation please **DO** the following:

- Read the user manual:
 - The user manual provides a complete description of the KINO-DH810 installation instructions and configuration options.
- Wear an electrostatic discharge cuff (ESD):
 - Electronic components are easily damaged by ESD. Wearing an ESD cuff removes ESD from the body and helps prevent ESD damage.
- Place the KINO-DH810 on an antistatic pad:
 - When installing or configuring the motherboard, place it on an antistatic pad. This helps to prevent potential ESD damage.
- Turn all power to the KINO-DH810 off:
 - When working with the KINO-DH810, make sure that it is disconnected from all power supplies and that no electricity is being fed into the system.

KINO-DH810

Before and during the installation of the KINO-DH810 **DO NOT:**

- Remove any of the stickers on the PCB board. These stickers are required for warranty validation.
- Use the product before verifying all the cables and power connectors are properly connected.
- Allow screws to come in contact with the PCB circuit, connector pins, or its components.

4.3 Basic Installation



WARNING:

A CPU should never be turned on without the specified cooling kit being installed. If the cooling kit (heat sink and fan) is not properly installed and the system turned on, permanent damage to the CPU, KINO-DH810 and other electronic components attached to the system may be incurred. Running a CPU without a cooling kit may also result in injury to the user.

The CPU, CPU cooling kit and DIMM are the most critical components of the KINO-DH810. If one of these component is not installed the KINO-DH810 cannot run.

4.3.1 Socket LGA1150 CPU Installation



WARNING:

CPUs are expensive and sensitive components. When installing the CPU please be careful not to damage it in anyway. Make sure the CPU is installed properly and ensure the correct cooling kit is properly installed.

Do NOT touch the pins at the bottom of the CPU. When handling the CPU, only hold it on the sides.

To install the CPU, follow the steps below.

Step 1: Disengage the load lever by pressing the lever down and slightly outwards to clear the retention tab. Fully open the lever. See **Figure 4-1**.

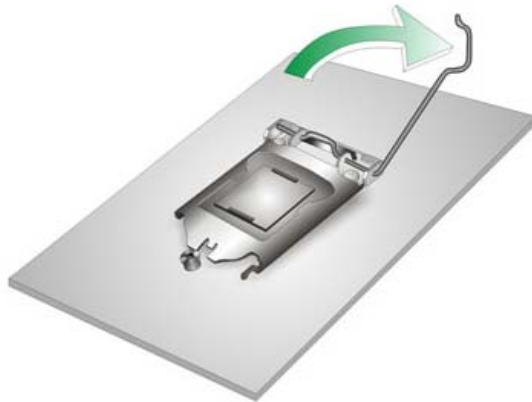

Figure 4-1: Disengage the CPU Socket Load Lever

Step 2: Open the socket and remove the protective cover. The black protective cover can be removed by pulling up on the tab labeled “Remove”. See **Figure 4-2**.

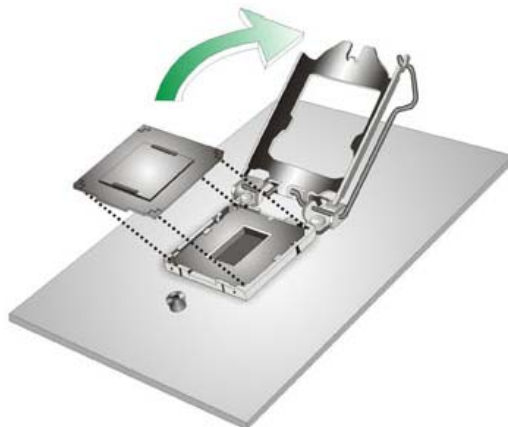

Figure 4-2: Remove Protective Cover

Step 3: Inspect the CPU socket. Make sure there are no bent pins and make sure the socket contacts are free of foreign material. If any debris is found, remove it with compressed air.

KINO-DH810

- Step 4: Orientate the CPU properly.** The contact array should be facing the CPU socket.
- Step 5: Correctly position the CPU.** Match the Pin 1 mark with the CPU edge on the CPU socket.
- Step 6: Align the CPU pins.** Locate pin 1 and the two orientation notches on the CPU. Carefully match the two orientation notches on the CPU with the socket alignment keys.
- Step 7: Insert the CPU.** Gently insert the CPU into the socket. If the CPU pins are properly aligned, the CPU should slide into the CPU socket smoothly. See **Figure 4-3**.



Figure 4-3: Insert the Socket LGA1150 CPU

- Step 8: Close the CPU socket.** Close the load plate and pull the load back a little to have the load plate be able to secure to the knob. Engage the load lever by pushing it back to its original position. See **Figure 4-4**. There will be some resistance, but will not require extreme pressure.

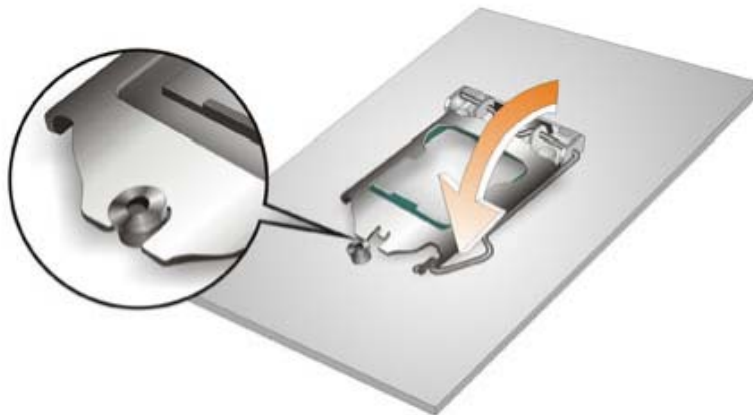

Figure 4-4: Close the Socket LGA1150

Step 9: Connect the 12 V power to the board. Connect the 12 V power from the power supply to the board.

4.3.2 Cooling Kit Installation



WARNING:

DO NOT attempt to install a push-pin cooling fan.

The pre-installed support bracket prevents the board from bending and is ONLY compatible with captive screw type cooling fans.

The cooling kits can be bought from IEI. The cooling kit has a heat sink and fan.



WARNING:

Do not wipe off (accidentally or otherwise) the pre-sprayed layer of thermal paste on the bottom of the heat sink. The thermal paste between the CPU and the heat sink is important for optimum heat dissipation.

KINO-DH810

To install the cooling kit, follow the instructions below.

Step 1: A cooling kit bracket is pre-installed on the rear of the motherboard. See **Figure 4-5**.

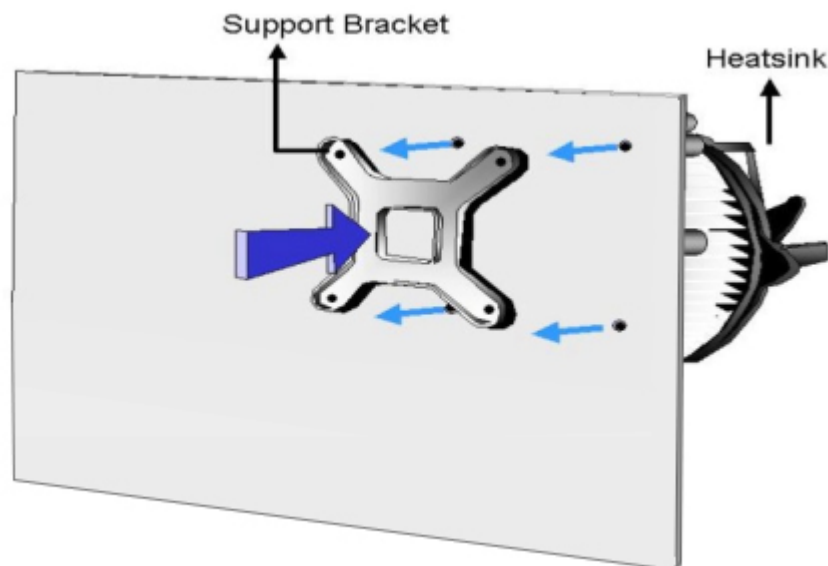

Figure 4-5: Cooling Kit Support Bracket

Step 2: Place the cooling kit onto the socket LGA1150 CPU. Make sure the CPU cable can be properly routed when the cooling kit is installed.

Step 3: Mount the cooling kit. Gently place the cooling kit on top of the CPU. Make sure the four threaded screws on the corners of the cooling kit properly pass through the holes of the cooling kit bracket.

Step 4: Secure the cooling kit by fastening the four retention screw of the cooling kit.

Step 5: Connect the fan cable. Connect the cooling kit fan cable to the fan connector on the KINO-DH810. Carefully route the cable and avoid heat generating chips and fan blades.

4.3.3 SO-DIMM Installation

To install a SO-DIMM, please follow the steps below and refer to **Figure 4-6**.

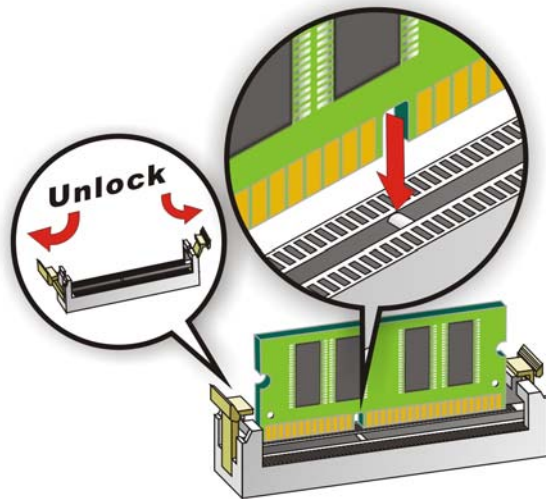

Figure 4-6: SO-DIMM Installation

- Step 1:** **Open the SO-DIMM socket handles.** Open the two handles outwards as far as they can. See **Figure 4-6**.
- Step 2:** **Align the SO-DIMM with the socket.** Align the DIMM so the notch on the memory lines up with the notch on the memory socket. See **Figure 4-6**.
- Step 3:** **Insert the SO-DIMM.** Once aligned, press down until the SO-DIMM is properly seated. Clip the two handles into place. See **Figure 4-6**.
- Step 4:** **Removing a SO-DIMM.** To remove a SO-DIMM, push both handles outward. The memory module is ejected by a mechanism in the socket.

4.4 Internal Peripheral Device Connections

This section outlines the installation of peripheral devices to the on-board connectors

4.4.1 SATA Drive Connection

The KINO-DH810 is shipped with two SATA drive cable. To connect the SATA drive to the connector, please follow the steps below.

Step 1: Locate the SATA connector and the SATA power connector. The locations of the connectors are shown in **Chapter 3**.

Step 2: Insert the cable connector. Insert the cable connector into the on-board SATA drive connector and the SATA power connector. See **Figure 4-7**.

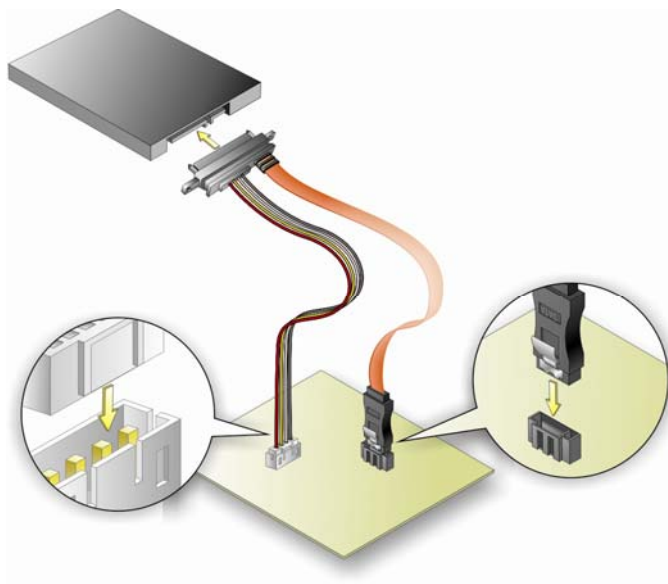

Figure 4-7: SATA Drive Cable Connection

Step 3: Connect the cable to the SATA disk. Connect the connector on the other end of the cable to the connector at the back of the SATA drive. See **Figure 4-7**.

Step 4: To remove the SATA cable from the SATA connector, press the clip on the connector at the end of the cable.

Chapter

5

BIOS

5.1 Introduction

The BIOS is programmed onto the BIOS chip. The BIOS setup program allows changes to certain system settings. This chapter outlines the options that can be changed.

5.1.1 Starting Setup

The UEFI BIOS is activated when the computer is turned on. The setup program can be activated in one of two ways.

1. Press the **DELETE** or **F2** key as soon as the system is turned on or
2. Press the **DELETE** or **F2** key when the “**Press Del to enter SETUP**” message appears on the screen.

If the message disappears before the **DELETE** or **F2** key is pressed, restart the computer and try again.

5.1.2 Using Setup

Use the arrow keys to highlight items, press **ENTER** to select, use the PageUp and PageDown keys to change entries, press **F1** for help and press **ESC** to quit. Navigation keys are shown in.

Key	Function
Up arrow	Move to the item above
Down arrow	Move to the item below
Left arrow	Move to the item on the left hand side
Right arrow	Move to the item on the right hand side
+	Increase the numeric value or make changes
-	Decrease the numeric value or make changes
Page up	Move to the next page
Page down	Move to the previous page

Key	Function
Esc	Main Menu – Quit and do not save changes into CMOS Status Page Setup Menu and Option Page Setup Menu -- Exit current page and return to Main Menu
F1	General help, only for Status Page Setup Menu and Option Page Setup Menu
F2	Load previous values
F3	Load optimized defaults
F4	Save changes and Exit BIOS

Table 5-1: BIOS Navigation Keys

5.1.3 Getting Help

When **F1** is pressed a small help window describing the appropriate keys to use and the possible selections for the highlighted item appears. To exit the Help Window press **Esc** or the **F1** key again.

5.1.4 Unable to Reboot after Configuration Changes

If the computer cannot boot after changes to the system configuration is made, CMOS defaults. Use the clear CMOS button described in Chapter 3.

5.1.5 BIOS Menu Bar

The **menu bar** on top of the BIOS screen has the following main items:

- Main – Changes the basic system configuration.
- Advanced – Changes the advanced system settings.
- Chipset – Changes the chipset settings.
- Boot – Changes the system boot configuration.
- Security – Sets User and Supervisor Passwords.
- Save & Exit – Selects exit options and loads default settings

The following sections completely describe the configuration options found in the menu items at the top of the BIOS screen and listed above.

KINO-DH810

5.2 Main

The **Main** BIOS menu (**BIOS Menu 1**) appears when the **BIOS Setup** program is entered.

The **Main** menu gives an overview of the basic system information.

Aptio Setup Utility - Copyright (C) 2012 American Megatrends, Inc.					
Main	Advanced	Chipset	Boot	Security	Save & Exit
BIOS Information					
BIOS Vendor	American Megatrends		Choose the system default language.		
Core Version	4.6.5.4				
Compliancy	UEFI 2.3.1; PI 1.2				
Project Version	SAA2AR11.ROM				
Build Date	11/29/2013 08:20:40				
iWDD Vendor	iEi				
iWDD Version	SAA2ET02.bin				
Processor Information					
Name	Haswell				
Brand String	Intel(R) Core(TM) i5-4570S CPU @ 2.90GHz				
Frequency	3200 MHz				
Processor ID	306c3				
Stepping	C0				
Number of Processors	4Core(s) / 4Thread(s)				
Microcode Revision	8				
GT Info	GT3 (700 MHz)				
IGFX VBIOS Version	2170				
Memory RC Version	1.4.0.3				
Total Memory	4096 MB (DDR3)				
Memory Frequency	1600 MHz				
PCH Information					
Name	LynxPoint				
PCH SKU	H81				
Stepping	05/C2				
LAN PHY Revision	N/A				
ME FW Version	9.0.13.1402				
ME Firmware SKU	1.5MB				
SPI Clock Frequency					
DOFR Support	Supported				
Read Status Clock Frequency	50 MHz				
Write Status Clock Frequency	50 MHz				
Fast Read Status Clock Frequency	50 MHz				
System Language	[English]				
System Date	[Tue 12/03/2012]				
System Time	[19:43:27]				
Access Level	Administrator				

			←→: Select Screen ↑ ↓: Select Item Enter>Select F1 General Help F2 Previous Values F3 Optimized Defaults F4 Save ESC Exit		
Version 2.15.1231. Copyright (C) 2012 American Megatrends, Inc.					

BIOS Menu 1: Main

The Main menu lists the following system details:

- BIOS Information
- Processor Information
- Memory Information
- PCH Information
- SPI Clock Frequency

The Main menu has two user configurable fields:

→ **System Date [xx/xx/xx]**

Use the **System Date** option to set the system date. Manually enter the day, month and year.

→ **System Time [xx:xx:xx]**

Use the **System Time** option to set the system time. Manually enter the hours, minutes and seconds.

5.3 Advanced

Use the **Advanced** menu (**BIOS Menu 2**) to configure the CPU and peripheral devices through the following sub-menus:



WARNING!

Setting the wrong values in the sections below may cause the system to malfunction. Make sure that the settings made are compatible with the hardware.

KINO-DH810

```

Aptio Setup Utility - Copyright (C) 2012 American Megatrends, Inc.
Main  Advanced  Chipset  Boot  Security  Save & Exit
-----
> ACPI Settings
> Trusted Computing
> CPU Configuration
> SATA Configuration
> USB Configuration
> F81866 Super IO Configuration
> F81866 H/M Monitor
> Serial Port Console Redirection
> iEi Feature

System ACPI Parameters
-----
<->: Select Screen
↑↓: Select Item
EnterSelect
F1  General Help
F2  Previous Values
F3  Optimized Defaults
F4  Save
ESC Exit

Version 2.15.1231. Copyright (C) 2012 American Megatrends, Inc.

```

BIOS Menu 2: Advanced

5.3.1 ACPI Configuration

The **ACPI Configuration** menu (**BIOS Menu 3**) configures the Advanced Configuration and Power Interface (ACPI) options.

```

Aptio Setup Utility - Copyright (C) 2012 American Megatrends, Inc.
Advanced
-----
ACPI Settings
ACPI Sleep State          [S1 only (CPU Stop
                          Clock)]

Select the highest ACPI
sleep state the system
will enter when the
SUSPEND button is
pressed.
-----
<->: Select Screen
↑↓: Select Item
EnterSelect
F1  General Help
F2  Previous Values
F3  Optimized
Defaults
F4  Save
ESC Exit

Version 2.15.1231. Copyright (C) 2012 American Megatrends, Inc.

```

BIOS Menu 3: ACPI Configuration

→ ACPI Sleep State [S1 only (CPU Stop Clock)]

Use the **ACPI Sleep State** option to specify the sleep state the system enters when it is not being used.

- **Suspend Disabled** Disable the suspend function.
- **S1 only (CPU Stop Clock)** **DEFAULT** The system enters S1 (POS) sleep state. The system appears off. The CPU is stopped; RAM is refreshed; the system is running in a low power mode.
- **S3 only (Suspend to RAM)** The caches are flushed and the CPU is powered off. Power to the RAM is maintained. The computer returns slower to a working state, but more power is saved.
- **Both S1 and S3 available for OS to choose from** Both S1 and S3 are available, for OS to choose.

5.3.2 Trusted Computing

Use the **Trusted Computing** menu (**BIOS Menu 4**) to configure settings related to the Trusted Computing Group (TCG) Trusted Platform Module (TPM).

KINO-DH810

```

Aptio Setup Utility - Copyright (C) 2012 American Megatrends, Inc.
  Advanced
-----
Configuration
  Security Device Support          [Disable]
Current Status Information
  NO Security Device Found
-----
                                  Enable or Disable BIOS
                                  support for security
                                  device. O.S. will not
                                  show Security Device.
                                  TCG EFI protocol and
                                  INT1A interface will not
                                  be available.
-----
                                  <->: Select Screen
                                  ↑ ↓: Select Item
                                  Enter>Select
                                  F1   General Help
                                  F2   Previous Values
                                  F3   Optimized
                                  Defaults
                                  F4   Save
                                  ESC  Exit
-----
Version 2.15.1231. Copyright (C) 2012 American Megatrends, Inc.

```

BIOS Menu 4: Trusted Computing

→ Security Device Support [Disable]

Use the **Security Device Support** option to configure support for the security device.

- **Disable** **DEFAULT** Security device support is disabled.
- **Enable** Security device support is enabled.

5.3.3 CPU Configuration

Use the **CPU Configuration** menu (**BIOS Menu 5**) to view detailed CPU specifications and configure the CPU.

```

Aptio Setup Utility - Copyright (C) 2012 American Megatrends, Inc.
  Advanced
CPU Configuration
Intel(R) Core(TM) i5-4570S CPU @ 2.90GHz
CPU Signature          306c3
Microcode Patch       8
Max CPU Speed         2900 MHz
Min CPU Speed         800 MHz
CPU Speed             3200 MHz
Processor Cores       4
Intel HT Technology   Not Supported
Intel VT-x Technology Supported
Intel SMX Technology Supported
64-bit                Supported
EIST Technology       Supported
CPU C3 state          Supported
CPU C6 state          Supported
CPU C7 state          Supported

L1 Data Cache        32 KB x 4
L1 Code Cache        32 KB x 4
L2 Cache             256 KB x 4
L3 Cache             6144 KB

Active Processor Cores [All]
Intel Virtualization Technology [Enabled]
EIST                  [Enabled]
Intel TXT(LT) Support [Disabled]

Number of cores to enable
in each processor
package.
-----
<->: Select Screen
↑ ↓: Select Item
Enter>Select
F1   General Help
F2   Previous Values
F3   Optimized
Defaults
F4   Save
ESC  Exit

Version 2.15.1231. Copyright (C) 2012 American Megatrends, Inc.
    
```

BIOS Menu 5: CPU Configuration

➔ Active Processor Cores [All]

Use the **Active Processor Cores** option to configure the number of the active processor cores.

- ➔ **All** **DEFAULT** Active all of the processor cores
- ➔ **1** Active one of the processor cores
- ➔ **2** Active two of the processor cores

KINO-DH810

→ **3** Active three of the processor cores

→ **Intel Virtualization Technology [Enabled]**

Use the **Intel Virtualization Technology** option to enable or disable virtualization on the system. When combined with third party software, Intel Virtualization technology allows several OSs to run on the same system at the same time.

→ **Disabled** Disables Intel Virtualization Technology.

→ **Enabled** **DEFAULT** Enables Intel Virtualization Technology.

→ **EIST [Enabled]**

Use the **EIST** BIOS option to enable or disable Intel SpeedStep Technology.

→ **Disabled** Disables Intel SpeedStep Technology.

→ **Enabled** **DEFAULT** Enables Intel SpeedStep Technology.

→ **Intel TXT(LT) Support [Disabled]**

Use the **Intel TXT(LT) Support** BIOS option to enable or disable the Intel Trusted Execution Technology.

→ **Disabled** **DEFAULT** Disables the Intel Trusted Execution Technology.

→ **Enabled** Enables the Intel Trusted Execution Technology.

5.3.4 SATA Configuration

Use the **SATA Configuration** menu (**BIOS Menu 6**) to change and/or set the configuration of the SATA devices installed in the system.

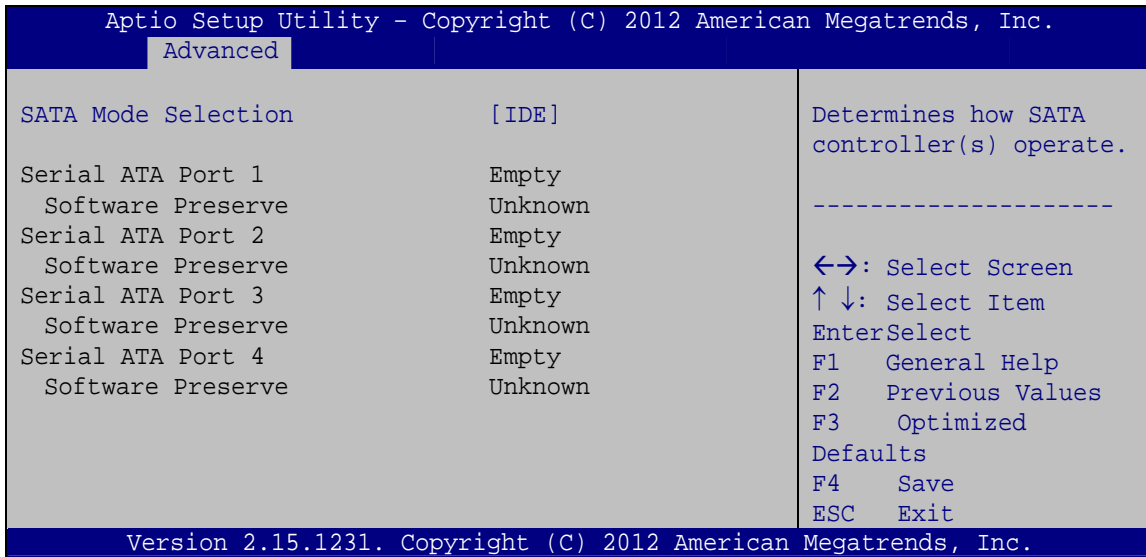

BIOS Menu 6: SATA Configuration

→ SATA Mode Selection [IDE]

Use the **SATA Mode Selection** option to configure SATA devices as normal IDE devices.

- **IDE** **DEFAULT** Configures SATA devices as normal IDE device.
- **AHCI** Configures SATA devices as AHCI device.

KINO-DH810

5.3.5 USB Configuration

Use the **USB Configuration** menu (**BIOS Menu 7**) to read USB configuration information and configure the USB settings.

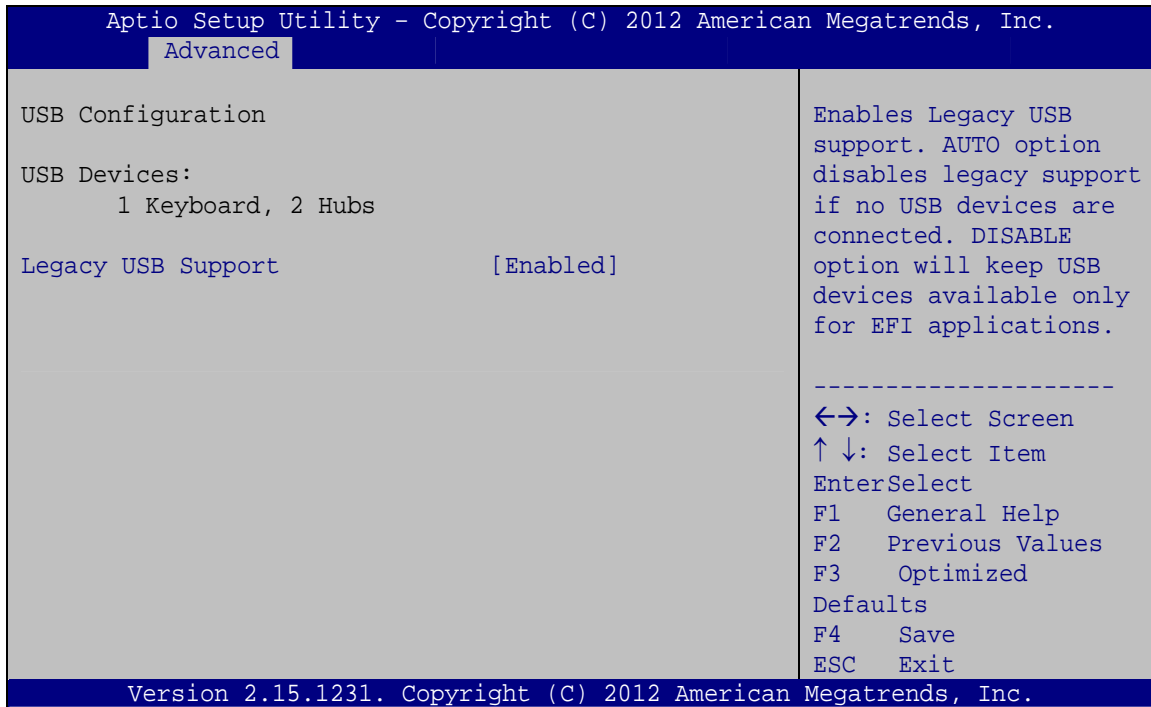

BIOS Menu 7: USB Configuration

→ USB Devices

The **USB Devices Enabled** field lists the USB devices that are enabled on the system

→ Legacy USB Support [Enabled]

Use the **Legacy USB Support** BIOS option to enable USB mouse and USB keyboard support. Normally if this option is not enabled, any attached USB mouse or USB keyboard does not become available until a USB compatible operating system is fully booted with all USB drivers loaded. When this option is enabled, any attached USB mouse or USB keyboard can control the system even when there is no USB driver loaded onto the system.

→ **Enabled** **DEFAULT** Legacy USB support enabled

- ➔ **Disabled** Legacy USB support disabled
- ➔ **Auto** Legacy USB support disabled if no USB devices are connected

5.3.6 F81866 Super IO Configuration

Use the **F81866 Super IO Configuration** menu (**BIOS Menu 8**) to set or change the configurations for the serial ports.

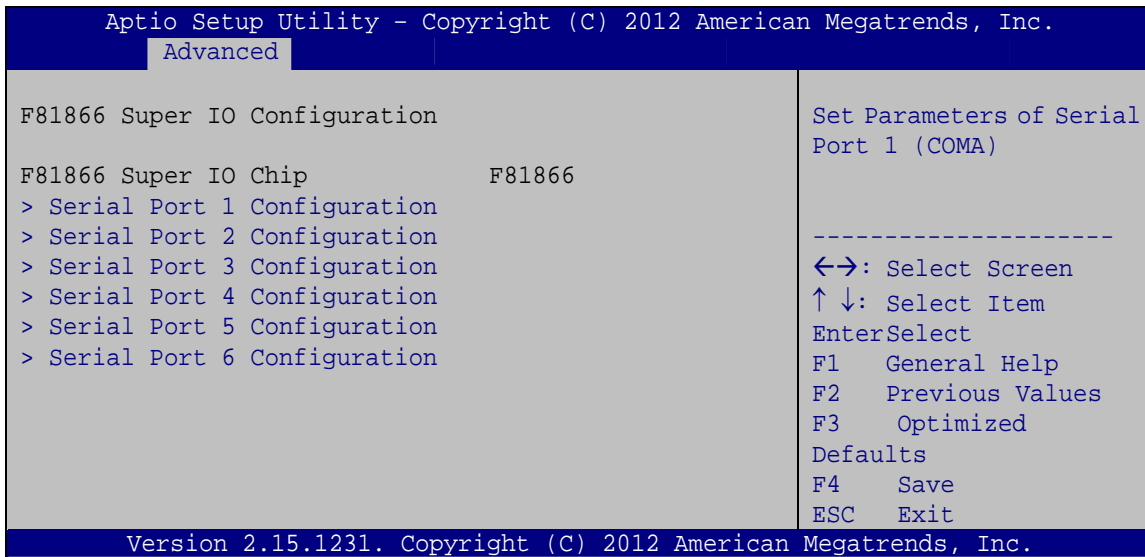

BIOS Menu 8: Super IO Configuration

KINO-DH810

5.3.6.1 Serial Port n Configuration

Use the **Serial Port n Configuration** menu (**BIOS Menu 9**) to configure the serial port n.

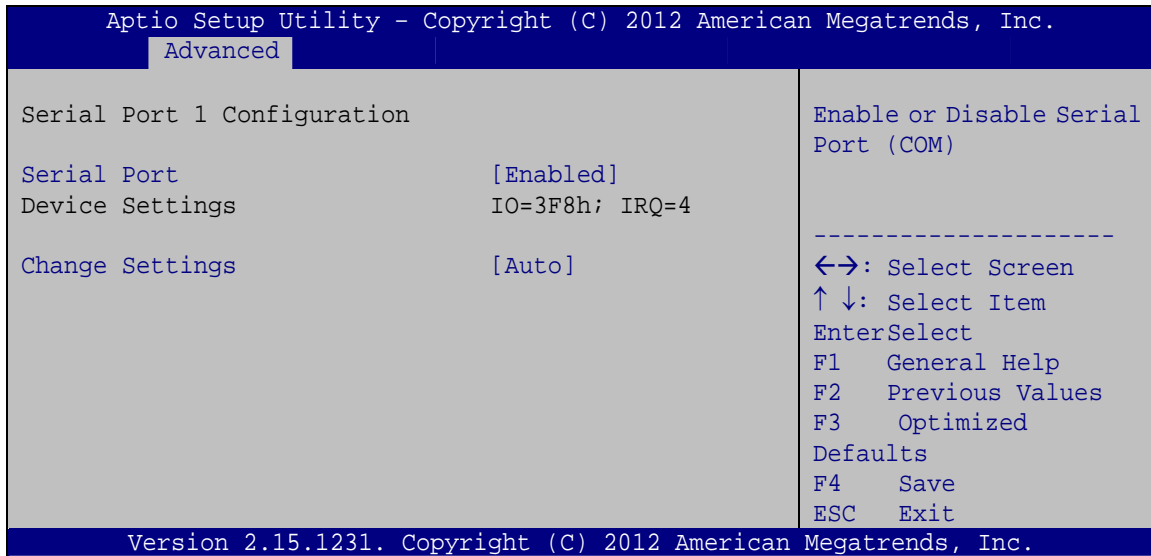

BIOS Menu 9: Serial Port n Configuration Menu

5.3.6.1.1 Serial Port 1 Configuration

→ Serial Port [Enabled]

Use the **Serial Port** option to enable or disable the serial port.

- **Disabled** Disable the serial port
- **Enabled** **DEFAULT** Enable the serial port

→ Change Settings [Auto]

Use the **Change Settings** option to change the serial port IO port address and interrupt address.

- **Auto** **DEFAULT** The serial port IO port address and interrupt address are automatically detected.
- **IO=3F8h;**
IRQ=4 Serial Port I/O port address is 3F8h and the interrupt address is IRQ4

- ➔ **IO=3F8h;**
IRQ=3, 4 Serial Port I/O port address is 3E8h and the interrupt address is IRQ3, 4
- ➔ **IO=2F8h;**
IRQ=3, 4 Serial Port I/O port address is 2F8h and the interrupt address is IRQ3, 4

5.3.6.1.2 Serial Port 2 Configuration

➔ Serial Port [Enabled]

Use the **Serial Port** option to enable or disable the serial port.

- ➔ **Disabled** Disable the serial port
- ➔ **Enabled** **DEFAULT** Enable the serial port

➔ Change Settings [Auto]

Use the **Change Settings** option to change the serial port IO port address and interrupt address.

- ➔ **Auto** **DEFAULT** The serial port IO port address and interrupt address are automatically detected.
- ➔ **IO=2F8h;**
IRQ=3 Serial Port I/O port address is 2F8h and the interrupt address is IRQ3
- ➔ **IO=3F8h;**
IRQ=3, 4 Serial Port I/O port address is 3F8h and the interrupt address is IRQ3, 4
- ➔ **IO=2F8h;**
IRQ=3, 4 Serial Port I/O port address is 2F8h and the interrupt address is IRQ3, 4

➔ Device Mode [RS232]

The **Device Mode** shows Serial Port 2 provides RS-232 communications.

KINO-DH810

5.3.6.1.3 Serial Port 3 Configuration

→ Serial Port [Enabled]

Use the **Serial Port** option to enable or disable the serial port.

- **Disabled** Disable the serial port
- **Enabled** **DEFAULT** Enable the serial port

→ Change Settings [Auto]

Use the **Change Settings** option to change the serial port IO port address and interrupt address.

- **Auto** **DEFAULT** The serial port IO port address and interrupt address are automatically detected.
- **IO=3E8h;**
IRQ=10 Serial Port I/O port address is 3E8h and the interrupt address is IRQ10
- **IO=3E8h;**
IRQ=10, 11 Serial Port I/O port address is 3E8h and the interrupt address is IRQ10, 11
- **IO=2E8h;**
IRQ=10, 11 Serial Port I/O port address is 2E8h and the interrupt address is IRQ10, 11

→ Device Mode [RS232]

The **Device Mode** shows Serial Port 3 provides RS-232 communications.

5.3.6.1.4 Serial Port 4 Configuration

→ Serial Port [Enabled]

Use the **Serial Port** option to enable or disable the serial port.

- **Disabled** Disable the serial port

→ **Enabled** **DEFAULT** Enable the serial port

→ **Change Settings [Auto]**

Use the **Change Settings** option to change the serial port IO port address and interrupt address.

→ **Auto** **DEFAULT** The serial port IO port address and interrupt address are automatically detected.

→ **IO=2E8h;**
IRQ=10 Serial Port I/O port address is 2E8h and the interrupt address is IRQ10

→ **IO=3E8h;**
IRQ=10, 11 Serial Port I/O port address is 3E8h and the interrupt address is IRQ10, 11

→ **IO=2E8h;**
IRQ=10, 11 Serial Port I/O port address is 2E8h and the interrupt address is IRQ10, 11

→ **Device Mode [RS232]**

The **Device Mode** shows Serial Port 4 provides RS-232 communications.

5.3.6.1.5 Serial Port 5 Configuration

→ **Serial Port [Enabled]**

Use the **Serial Port** option to enable or disable the serial port.

→ **Disabled** Disable the serial port

→ **Enabled** **DEFAULT** Enable the serial port

→ **Change Settings [Auto]**

Use the **Change Settings** option to change the serial port IO port address and interrupt address.

KINO-DH810

- ➔ **Auto** **DEFAULT** The serial port IO port address and interrupt address are automatically detected.
- ➔ **IO=2D0h;**
IRQ=10 Serial Port I/O port address is 2D0h and the interrupt address is IRQ10
- ➔ **IO=2D0h;**
IRQ=10, 11 Serial Port I/O port address is 2D0h and the interrupt address is IRQ10, 11
- ➔ **IO=2D8h;**
IRQ=10, 11 Serial Port I/O port address is 2D8h and the interrupt address is IRQ10, 11

➔ **Device Mode [RS232]**

The **Device Mode** shows Serial Port 5 provides RS-232 communications.

5.3.6.1.6 Serial Port 6 Configuration

➔ **Serial Port [Enabled]**

Use the **Serial Port** option to enable or disable the serial port.

- ➔ **Disabled** Disable the serial port
- ➔ **Enabled** **DEFAULT** Enable the serial port

➔ **Change Settings [Auto]**

Use the **Change Settings** option to change the serial port IO port address and interrupt address.

- ➔ **Auto** **DEFAULT** The serial port IO port address and interrupt address are automatically detected.
- ➔ **IO=2D8h;**
IRQ=10 Serial Port I/O port address is 2D8h and the interrupt address is IRQ10
- ➔ **IO=2D0h;**
IRQ=10, 11 Serial Port I/O port address is 2D0h and the interrupt address is IRQ10, 11

➔ **IO=2D8h;** Serial Port I/O port address is 2D8h and the interrupt
IRQ=10, 11 address is IRQ10, 11

➔ **Device Mode [RS485/RS422]**

The **Device Mode** shows Serial Port 6 provides RS-485/RS-422 communications.

5.3.7 F81866 H/W Monitor

The **F8186 H/W Monitor** menu (**BIOS Menu 10**) shows the operating temperature, fan speeds and system voltages.

```

Aptio Setup Utility - Copyright (C) 2012 American Megatrends, Inc.
  Advanced
PC Health Status
> Smart Fan Mode Configuration

CPU temperature      :+42 C
System temperature  :+31 C
Fan1 Speed          :1656 RPM
VCC3V               :+3.408 V
V_core              :+1.024 V
+1.05V              :+1.320 V
VDDR                :+1.520 V
VSB5V               :+5.040 V
VSB3V               :+3.376 V
VBAT                :+3.184 V

-----
<->: Select Screen
↑ ↓: Select Item
Enter>Select
F1   General Help
F2   Previous Values
F3   Optimized
Defaults
F4   Save
ESC  Exit

Version 2.15.1231. Copyright (C) 2012 American Megatrends, Inc.
    
```

BIOS Menu 10: Hardware Health Configuration

➔ **PC Health Status**

The following system parameters and values are shown. The system parameters that are monitored are:

- Temperatures:
 - CPU Temperature

KINO-DH810

- System Temperature
- Speed:
 - FAN1 Speed
- Voltages:
 - VCC3V
 - V_core
 - +1.05V
 - VDDR
 - VSB5V
 - VSB3V
 - VBAT

5.3.7.1 Smart Fan Mode Configuration

Use the **Smart Fan Mode Configuration** submenu (**BIOS Menu 11**) to configure the smart fan temperature and speed settings.

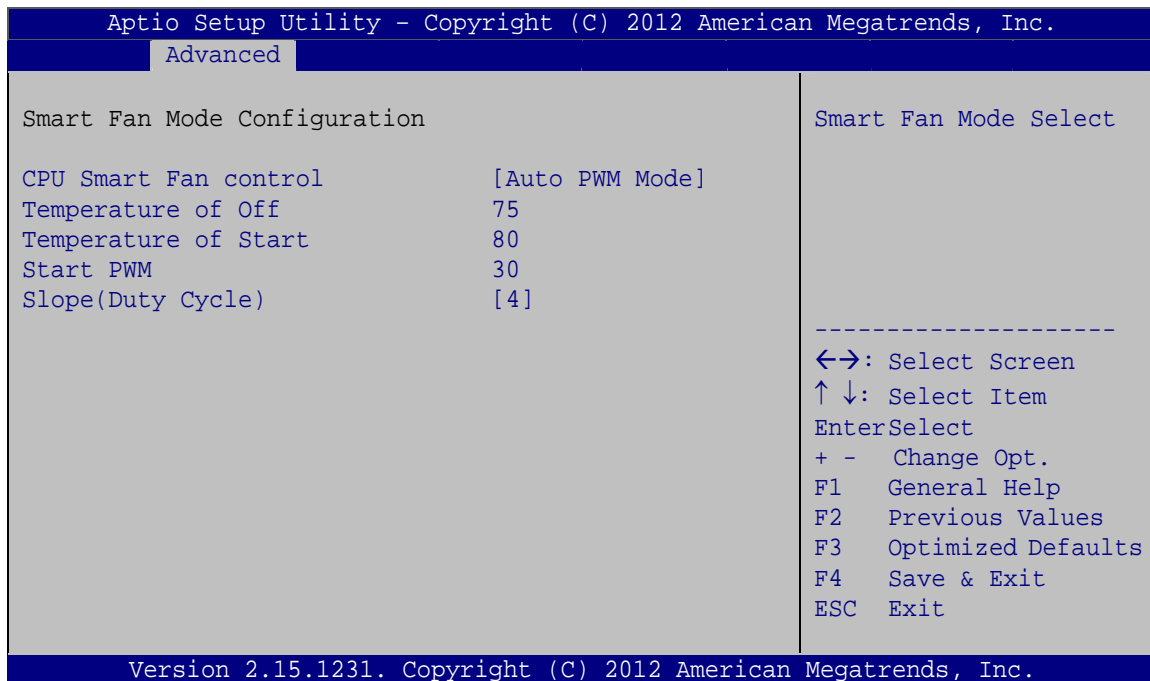

BIOS Menu 11: FAN 1 Configuration

→ CPU Smart Fan control [Auto PWM Mode]

Use the **CPU Smart Fan control** BIOS option to configure the CPU Smart Fan.

- **Full Mode** Fan is on all the time
- **Manual PWM Mode** The fan spins at the speed set in the manual PWM setting
- **Auto PWM Mode** **DEFAULT** The fan adjusts its speed using these settings:
 - Temperature of Start
 - Temperature of Off
 - Start PWM
 - Slope (Duty Cycle)

→ **Temperature of Off [75]**



WARNING:

Setting this value too high may cause the fan to speed up only when the CPU is at a very high temperature and therefore cause the system to be damaged.

The **Temperature of Off** option can only be set if the **CPU Smart Fan control** option is set to **Auto Mode**. When the **CPU Temperature** is lower than **Temperature of Off**, the fan speed change to be lowest. To set a value, select the **Temperature of Off** option and enter a decimal number between 0 and 127. The temperature range is specified below.

- Minimum Value: 0°C
- Maximum Value: 127°C

→ **Temperature of Start [80]**



WARNING:

Setting this value too high may cause the fan to rotate at full speed only when the CPU is at a very high temperature and therefore cause the

KINO-DH810

system to be damaged.

The **Temperature of Start** option can only be set if the **CPU Smart Fan control** option is set to **Auto Mode**. When the **CPU Temperature** is higher than **Temperature of Start**, the fan will be rotate at full speed. To set a value, select the **Temperature of Start** option and enter a decimal number between 0 and 127. The temperature range is specified below.

- Minimum Value: 0°C
- Maximum Value: 127°C

→ Temperature of Off [80]



WARNING:

Setting this value too high may cause the fan to speed up only when the CPU is at a very high temperature and therefore cause the system to be damaged.

The **Temperature of Off** option can only be set if the **CPU Smart Fan control** option is set to **Auto Mode**. When the **CPU Temperature** is higher than **Temperature of Off**, the fan will be speed up. To set a value, select the **Temperature of Off** option and enter a decimal number between 0 and 127. The temperature range is specified below.

- Minimum Value: 0°C
- Maximum Value: 127°C

→ Start PWM [30]

The **Start PWM** option can only be set if the **CPU Smart Fan control** option is set to **Auto Mode**. Use the **Start PWM** option to set the PWM start value. To set a value, select the **Start PWM** option and enter a decimal number between 0 and 100. The temperature range is specified below.

- Minimum Value: 0
- Maximum Value: 100

→ Slope (Duty Cycle) [4]

The **Slope (Duty Cycle)** option can only be set if the **CPU Smart Fan control** option is set to **Auto Mode**. Use the **Slope (Duty Cycle)** option to select the linear rate at which the PWM mode increases with respect to an increase in temperature. A list of available options is shown below:

- 0
- 1
- 2
- 4
- 8
- 16

5.3.8 Serial Port Console Redirection

The **Serial Port Console Redirection** menu (**BIOS Menu 12**) allows the console redirection options to be configured. Console redirection allows users to maintain a system remotely by re-directing keyboard input and text output through the serial port.

KINO-DH810

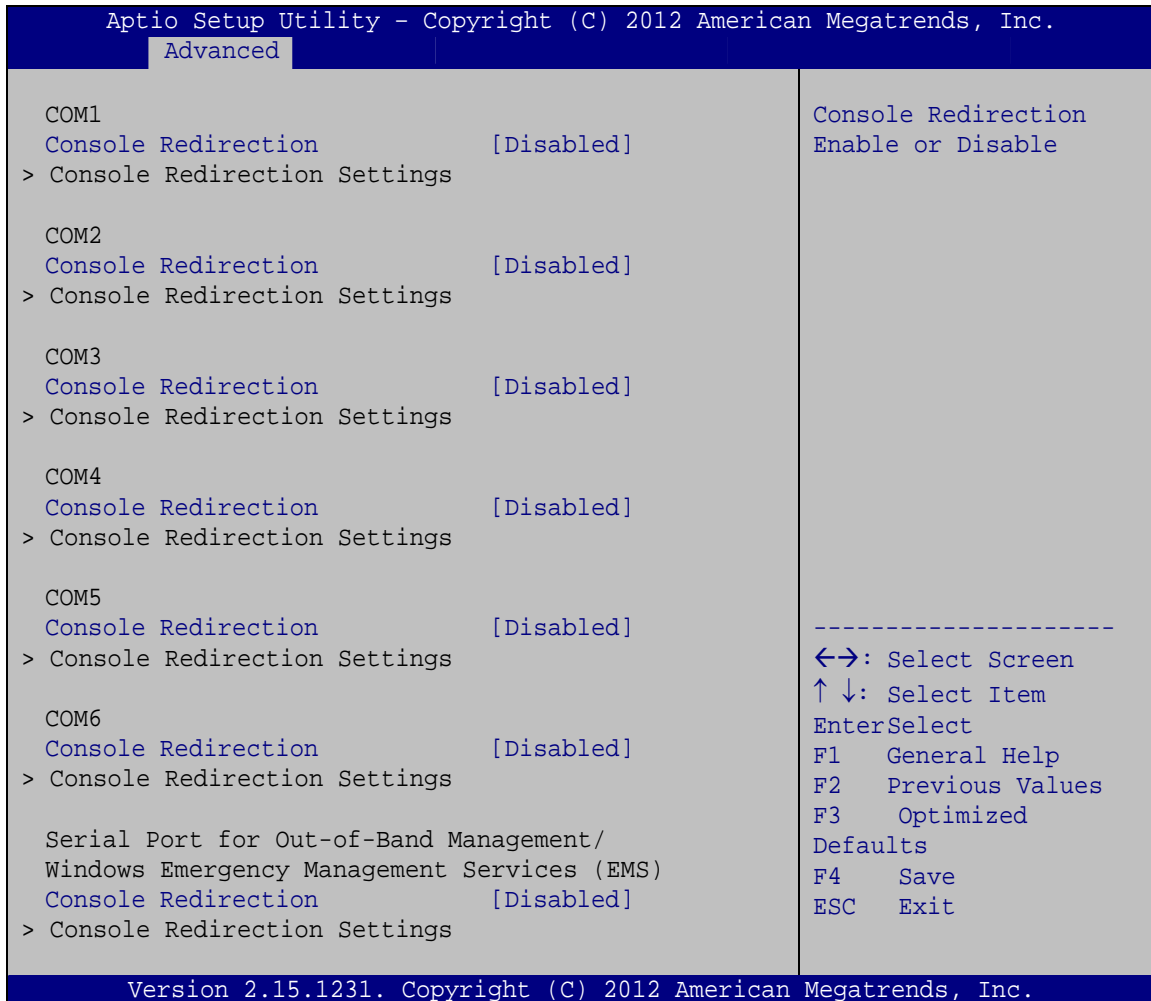

BIOS Menu 12: Serial Port Console Redirection

→ Console Redirection [Disabled]

Use **Console Redirection** option to enable or disable the console redirection function.

→ **Disabled** **DEFAULT** Disabled the console redirection function

→ **Enabled** Enabled the console redirection function

5.3.8.1 Console Redirection Settings

The **Console Redirection Settings** menu (**BIOS Menu 13**) allows the console redirection options to be configured. The option is active when Console Redirection option is enabled.

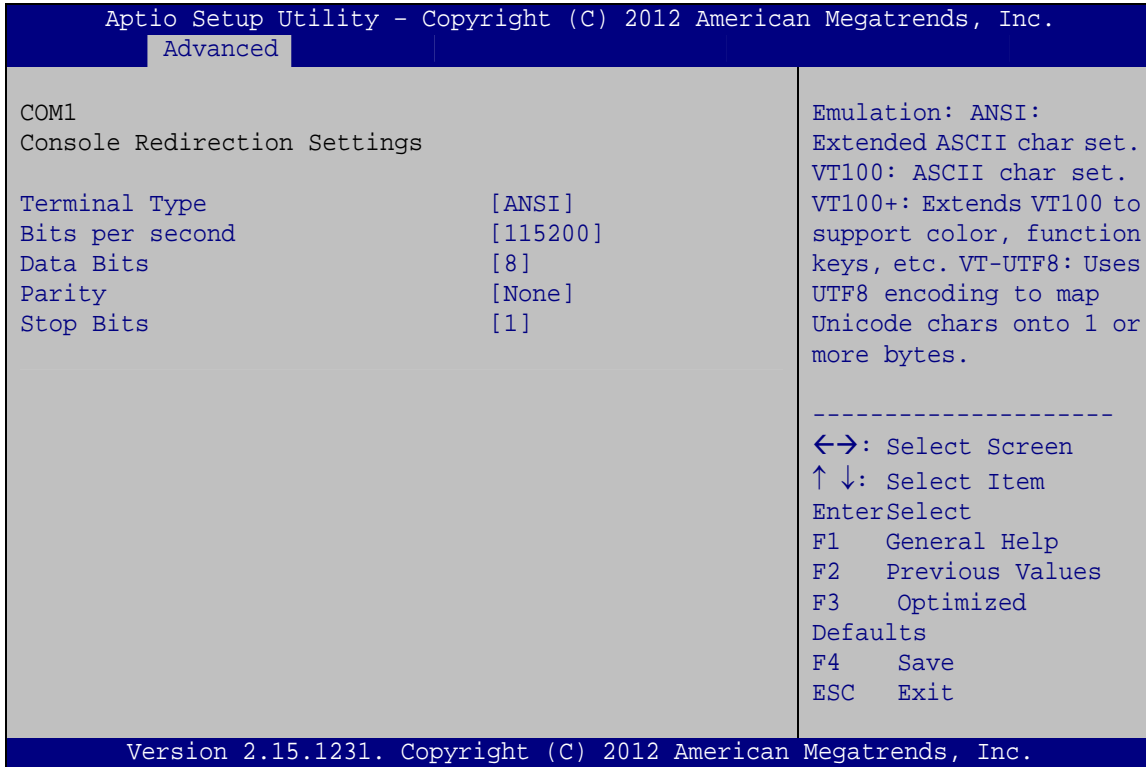

BIOS Menu 13: Console Redirection Settings

➔ **Terminal Type [ANSI]**

Use the **Terminal Type** option to specify the remote terminal type.

- ➔ **VT100** The target terminal type is VT100
- ➔ **VT100+** The target terminal type is VT100+
- ➔ **VT-UTF8** The target terminal type is VT-UTF8
- ➔ **ANSI** **DEFAULT** The target terminal type is ANSI

➔ **Bits per second [115200]**

Use the **Bits per second** option to specify the serial port transmission speed. The speed must match the other side. Long or noisy lines may require lower speeds.

- ➔ **9600** Sets the serial port transmission speed at 9600.
- ➔ **19200** Sets the serial port transmission speed at 19200.

KINO-DH810

- **38400** Sets the serial port transmission speed at 38400.
- **57600** Sets the serial port transmission speed at 57600.
- **115200** **DEFAULT** Sets the serial port transmission speed at 115200.

→ Data Bits [8]

Use the **Data Bits** option to specify the number of data bits.

- **7** Sets the data bits at 7.
- **8** **DEFAULT** Sets the data bits at 8.

→ Parity [None]

Use the **Parity** option to specify the parity bit that can be sent with the data bits for detecting the transmission errors.

- **None** **DEFAULT** No parity bit is sent with the data bits.
- **Even** The parity bit is 0 if the number of ones in the data bits is even.
- **Odd** The parity bit is 0 if the number of ones in the data bits is odd.
- **Mark** The parity bit is always 1. This option does not provide error detection.
- **Space** The parity bit is always 0. This option does not provide error detection.

→ Stop Bits [1]

Use the **Stop Bits** option to specify the number of stop bits used to indicate the end of a serial data packet. Communication with slow devices may require more than 1 stop bit.

- **1** **DEFAULT** Sets the number of stop bits at 1.
- **2** Sets the number of stop bits at 2.

5.3.9 IEI Feature

Use the **IEI Feature** menu (**BIOS Menu 14**) to configure One Key Recovery function.

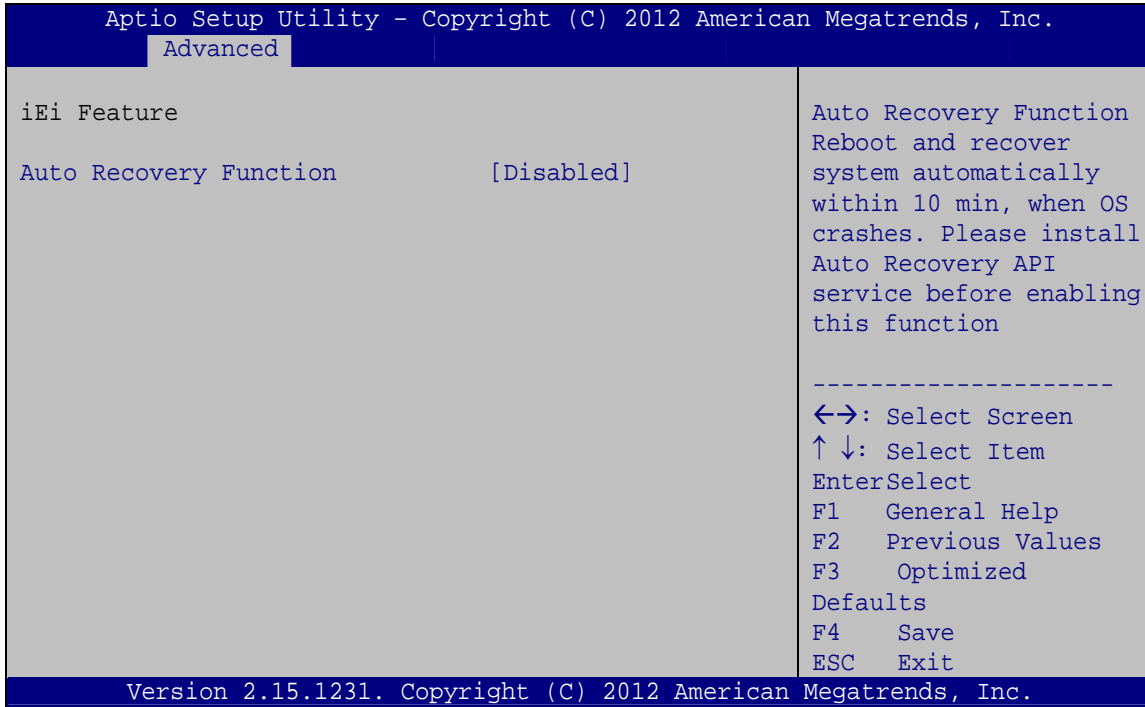

BIOS Menu 14: IEI Feature

➔ Auto Recovery Function [Disabled]

Use the **Auto Recovery Function** BIOS option to enable or disable the auto recovery function of the IEI One Key Recovery.

- ➔ **Disabled** **DEFAULT** Auto recovery function disabled
- ➔ **Enabled** Auto recovery function enabled

KINO-DH810

5.4 Chipset

Use the **Chipset** menu (**BIOS Menu 15**) to access the PCH-IO and System Agent (SA) configuration menus.

**WARNING!**

Setting the wrong values for the Chipset BIOS selections in the Chipset BIOS menu may cause the system to malfunction.

```
Aptio Setup Utility - Copyright (C) 2012 American Megatrends, Inc.
Main   Advanced  Chipset  Boot   Security  Save & Exit
-----
> PCH-IO Configuration
> System Agent (SA) Configuration

-----
<=>: Select Screen
↑↓: Select Item
Enter>Select
F1   General Help
F2   Previous Values
F3   Optimized
Defaults
F4   Save
ESC  Exit

Version 2.15.1236. Copyright (C) 2012 American Megatrends, Inc.
```

BIOS Menu 15: Chipset

5.4.1.1 PCH Azalia Configuration

Use the **PCH Azalia Configuration** submenu (**BIOS Menu 17**) to configure the PCH Azalia device.

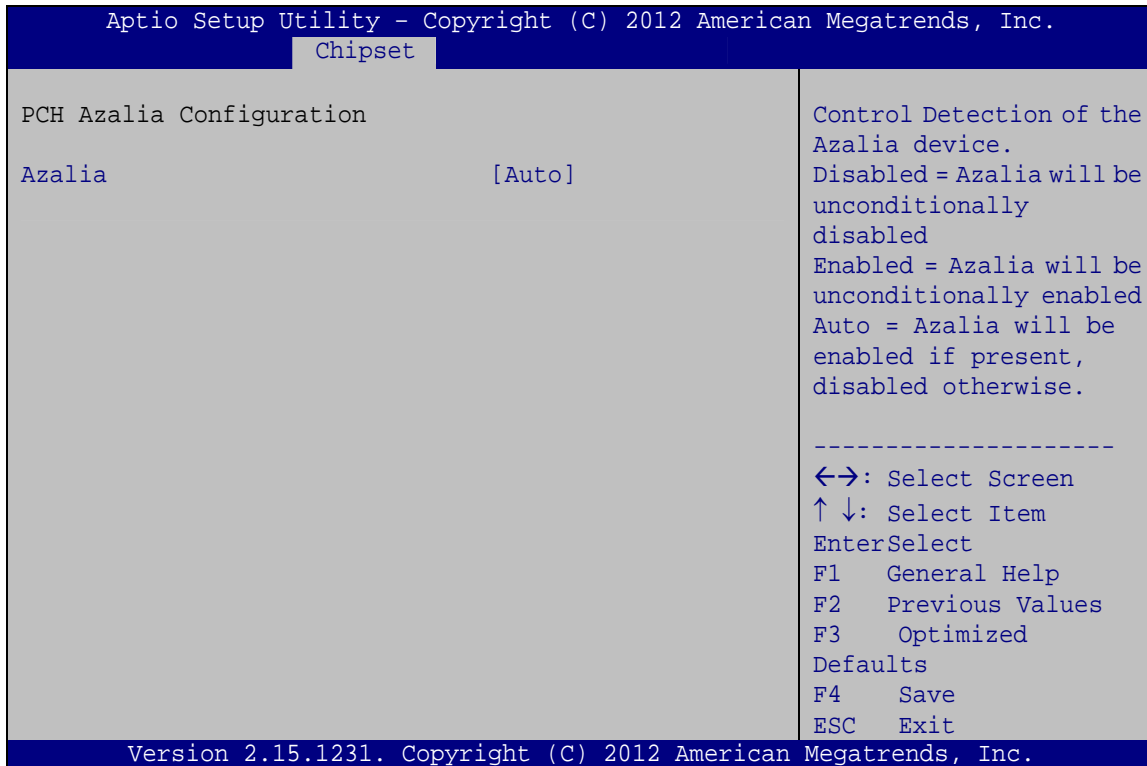

BIOS Menu 17:PCH-IO Configuration

→ Azalia [Auto]

Use the **Azalia** option to enable or disable the High Definition Audio controller.

- **Disabled** The onboard High Definition Audio controller is disabled
- **Enabled** The onboard High Definition Audio controller automatically detected and enabled
- **Auto** **DEFAULT** The onboard High Definition Audio controller will be enabled if present, disabled otherwise.

5.4.2 System Agent (SA) Configuration

Use the **System Agent (SA) Configuration** menu (**BIOS Menu 21**) to configure the graphics setting and memory setting.

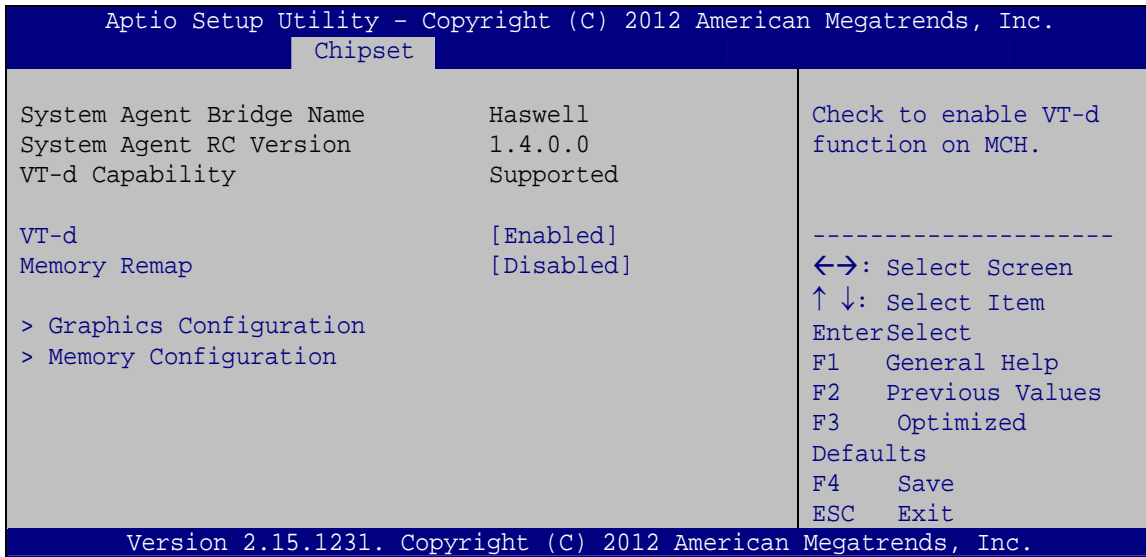

BIOS Menu 18: System Agent (SA) Configuration

→ VT-d [Enabled]

Use the **VT-d** option to enable or disable VT-d support.

- **Disabled** Disables VT-d support.
- **Enabled** **DEFAULT** Enables VT-d support.

→ Memory Remap [Disabled]

Use the **Memory Remap** option to enable or disable memory remap above 4G.

- **Disabled** **DEFAULT** Disables memory remap above 4G.
- **Enabled** Enables memory remap above 4G.

5.4.2.1 Graphics Configuration

Use the **Graphics Configuration** menu (**BIOS Menu 19**) to configure the video device connected to the system.

KINO-DH810

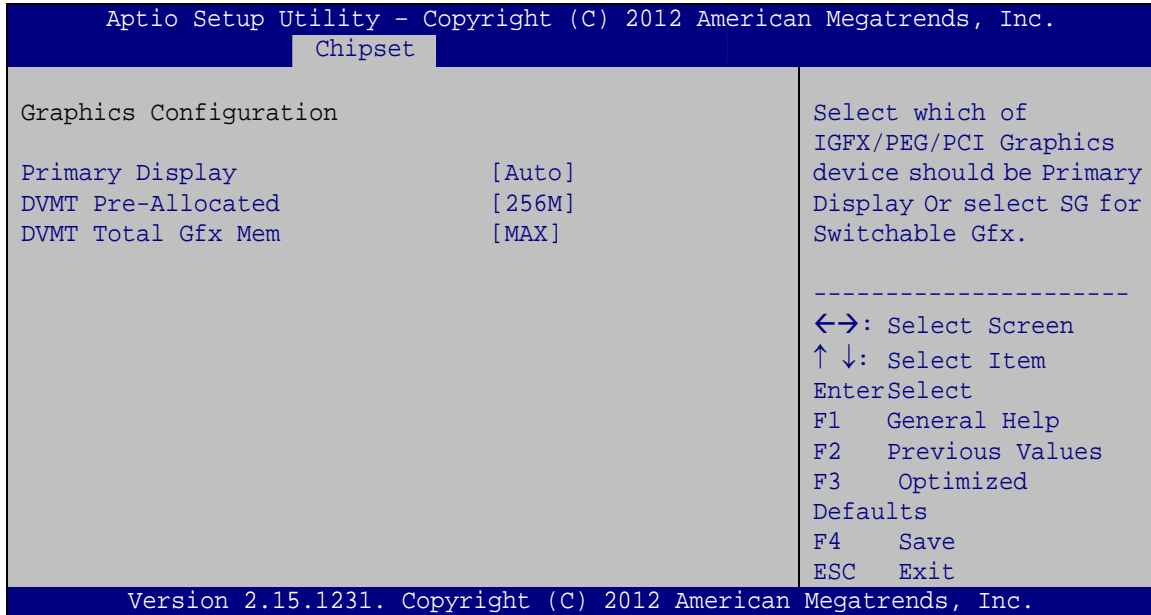

BIOS Menu 19: Graphics Configuration

→ Primary Display [Auto]

Use the **Primary Display** option to select the primary graphics controller the system uses. The following options are available:

- Auto **Default**
- IGFX
- PEG
- PCIE
- SG

→ DVMT Pre-Allocated [256MB]

Use the **DVMT Pre-Allocated** option to set the amount of system memory allocated to the integrated graphics processor when the system boots. The system memory allocated can then only be used as graphics memory, and is no longer available to applications or the operating system. Configuration options are listed below:

- 32M
- 64M
- 96M
- 128M

- 160M
- 192M
- 224M
- 256M **Default**
- 288M
- 320M
- 352M
- 384M
- 416M
- 448M
- 480M
- 512M
- 1024M

→ **DVMT Total Gfx Mem [MAX]**

Use the **DVMT Total Gfx Mem** option to select DVMT5.0 total graphic memory size used by the internal graphic device. The following options are available:

- 128M
- 256M
- MAX **Default**

5.4.2.2 Memory Configuration

Use the **Memory Configuration** submenu (**BIOS Menu 20**) to view memory information.

KINO-DH810

Aptio Setup Utility - Copyright (C) 2011 American Megatrends, Inc.

Chipset

Memory Information		
Memory Frequency	1600 MHz	
Total Memory	4096 MB (DDR3)	
Memory Voltage	1.50V	
DIMM#0	Not Present	
DIMM#1	Not Present	
DIMM#2	4096 MB (DDR3)	
DIMM#3	Not Present	

→←: Select Screen
 ↑ ↓: Select Item
 Enter: Select
 +/-: Change Opt.
 F1: General Help
 F2: Previous Values
 F3: Optimized Defaults
 F4: Save & Exit
 ESC: Exit

Version 2.14.1219. Copyright (C) 2011 American Megatrends, Inc.

BIOS Menu 20: Memory Configuration

5.5 Boot

Use the **Boot** menu (**BIOS Menu 21**) to configure system boot options.

Aptio Setup Utility - Copyright (C) 2012 American Megatrends, Inc.

Main Advanced Chipset **Boot** Security Save & Exit

Boot Configuration		Select the keyboard NumLock state
Bootup NumLock State	[On]	
Quiet Boot	[Enabled]	
Boot Option Priorities		-----
UEFI Boot	[Disabled]	←→: Select Screen
Launch PXE OpROM	[Disabled]	↑ ↓: Select Item
Option ROM Messages	[Force BIOS]	EnterSelect
		F1 General Help
		F2 Previous Values
		F3 Optimized Defaults
		F4 Save
		ESC Exit

Version 2.15.1231. Copyright (C) 2012 American Megatrends, Inc.

BIOS Menu 21: Boot

→ Bootup NumLock State [On]

Use the **Bootup NumLock State** BIOS option to specify if the number lock setting must be modified during boot up.

→ On **DEFAULT** Allows the Number Lock on the keyboard to be enabled automatically when the computer system boots up. This allows the immediate use of the 10-key numeric keypad located on the right side of the keyboard. To confirm this, the Number Lock LED light on the keyboard is lit.

→ Off Does not enable the keyboard Number Lock automatically. To use the 10-keys on the keyboard, press the Number Lock key located on the upper left-hand corner of the 10-key pad. The Number Lock LED on the keyboard lights up when the Number Lock is engaged.

→ Quiet Boot [Enabled]

Use the **Quiet Boot** BIOS option to select the screen display when the system boots.

→ Disabled Normal POST messages displayed

→ Enabled **DEFAULT** OEM Logo displayed instead of POST messages

→ UEFI Boot [Disabled]

Use the **UEFI Boot** option to enable or disable to boot from the UEFI devices.

→ Enabled Boot from UEFI devices is enabled.

→ Disabled **DEFAULT** Boot from UEFI devices is disabled.

→ Launch PXE OpROM [Disabled]

Use the **Launch PXE OpROM** option to enable or disable boot option for legacy network devices.

KINO-DH810

- ➔ **Disabled** **DEFAULT** Ignore all PXE Option ROMs
- ➔ **Enabled** Load PXE Option ROMs.

➔ **Option ROM Messages [Force BIOS]**

Use the **Option ROM Messages** option to set the Option ROM display mode.

- ➔ **Force BIOS** **DEFAULT** Sets display mode to force BIOS.
- ➔ **Keep Current** Sets display mode to current.

5.6 Security

Use the **Security** menu (**BIOS Menu 22**) to set system and user passwords.

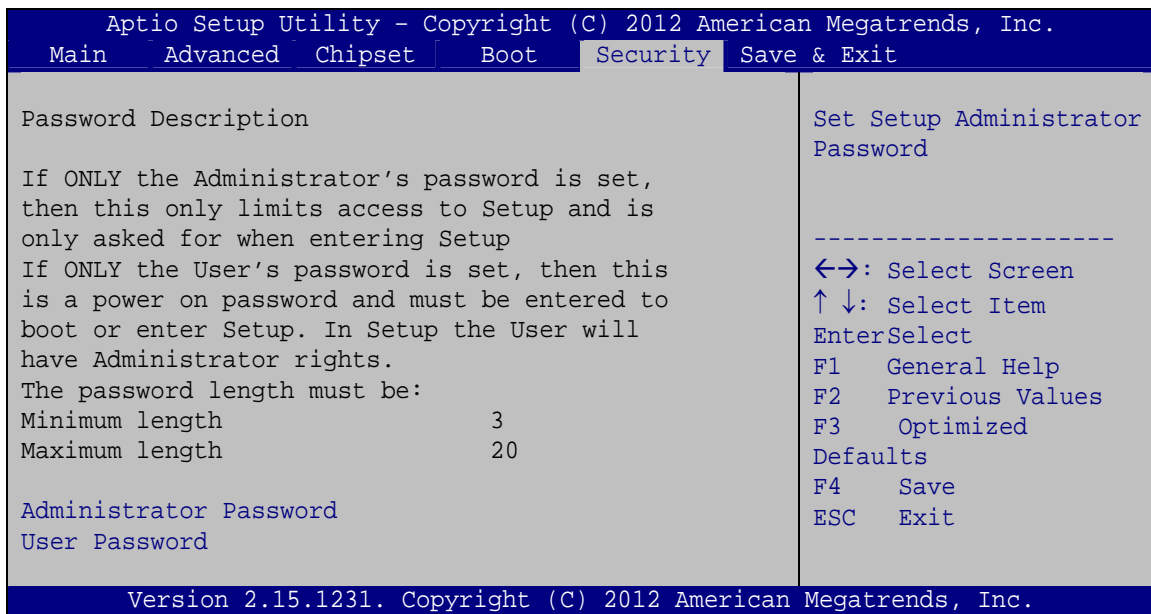

BIOS Menu 22: Security

➔ **Administrator Password**

Use the **Administrator Password** to set or change a administrator password.

➔ **User Password**

Use the **User Password** to set or change a user password.

5.7 Exit

Use the **Exit** menu (**BIOS Menu 23**) to load default BIOS values, optimal failsafe values and to save configuration changes.

```
Aptio Setup Utility - Copyright (C) 2012 American Megatrends, Inc.
Main   Advanced  Chipset  Boot   Security  Save & Exit
Save Changes and Exit
Discard Changes and Exit

Restore Defaults
Save as User Defaults
Restore User Defaults

Reset the system after
saving the changes.

-----
<->: Select Screen
↑ ↓: Select Item
Enter>Select
F1   General Help
F2   Previous Values
F3   Optimized
Defaults
F4   Save
ESC  Exit

Version 2.15.1231. Copyright (C) 2012 American Megatrends, Inc.
```

BIOS Menu 23:Exit

→ Save Changes and Exit

Use the **Save Changes and Exit** option to save the changes made to the BIOS options and to exit the BIOS configuration setup program.

→ Discard Changes and Exit

Use the **Discard Changes and Exit** option to exit the BIOS configuration setup program without saving the changes made to the system.

→ Restore Defaults

Use the **Restore Defaults** option to load the optimal default values for each of the parameters on the Setup menus. **F3 key can be used for this operation.**

KINO-DH810

→ **Save as User Defaults**

Use the **Save as User Defaults** option to save the changes done so far as user defaults.

→ **Restore User Defaults**

Use the **Restore User Defaults** option to restore the user defaults to all the setup options.

Appendix

A

Regulatory Compliance

DECLARATION OF CONFORMITY



This equipment has been tested and found to comply with specifications for CE marking. If the user modifies and/or installs other devices in the equipment, the CE conformity declaration may no longer apply.

FCC WARNING



This equipment complies with Part 15 of the FCC Rules. Operation is subject to the following two conditions:

- This device may not cause harmful interference, and
- This device must accept any interference received, including interference that may cause undesired operation.

This equipment has been tested and found to comply with the limits for a Class A digital device, pursuant to part 15 of the FCC Rules. These limits are designed to provide reasonable protection against harmful interference when the equipment is operated in a commercial environment. This equipment generates, uses, and can radiate radio frequency energy and, if not installed and used in accordance with the instruction manual, may cause harmful interference to radio communications. Operation of this equipment in a residential area is likely to cause harmful interference in which case the user will be required to correct the interference at his own expense.

Appendix

B

BIOS Menu Options

System Date [xx/xx/xx]	58
System Time [xx:xx:xx]	58
ACPI Sleep State [S1 only (CPU Stop Clock)]	60
Security Device Support [Disable]	61
Active Processor Cores [All]	62
Intel Virtualization Technology [Enabled]	63
EIST [Enabled]	63
Intel TXT(LT) Support [Disabled]	63
SATA Mode Selection [IDE]	64
USB Devices	65
Legacy USB Support [Enabled]	65
Serial Port [Enabled]	67
Change Settings [Auto]	67
Serial Port [Enabled]	68
Change Settings [Auto]	68
Device Mode [RS232]	68
Serial Port [Enabled]	69
Change Settings [Auto]	69
Device Mode [RS232]	69
Serial Port [Enabled]	69
Change Settings [Auto]	70
Device Mode [RS232]	70
Serial Port [Enabled]	70
Change Settings [Auto]	70
Device Mode [RS232]	71
Serial Port [Enabled]	71
Change Settings [Auto]	71
Device Mode [RS485/RS422]	72
PC Health Status	72
CPU Smart Fan control [Auto PWM Mode]	73
Temperature of Off [75]	74
Temperature of Start [80]	74
Temperature of Off [80]	75
Start PWM [30]	75

Slope (Duty Cycle) [4].....	76
Console Redirection [Disabled]	77
Terminal Type [ANSI].....	78
Bits per second [115200].....	78
Data Bits [8]	79
Parity [None].....	79
Stop Bits [1].....	79
Auto Recovery Function [Disabled].....	80
USB SW1 [+5V DUAL].....	82
USB SW2 [+5V DUAL].....	82
Azalia [Auto]	83
VT-d [Enabled].....	84
Memory Remap [Disabled].....	84
Primary Display [Auto]	85
DVMT Pre-Allocated [256MB].....	85
DVMT Total Gfx Mem [MAX].....	86
Bootup NumLock State [On].....	88
Quiet Boot [Enabled]	88
UEFI Boot [Disabled]	88
Launch PXE OpROM [Disabled].....	88
Option ROM Messages [Force BIOS].....	89
Administrator Password	89
User Password	89
Save Changes and Exit	90
Discard Changes and Exit.....	90
Restore Defaults	90
Save as User Defaults	91
Restore User Defaults	91

Appendix

C

Terminology

AC '97	Audio Codec 97 (AC'97) refers to a codec standard developed by Intel® in 1997.
ACPI	Advanced Configuration and Power Interface (ACPI) is an OS-directed configuration, power management, and thermal management interface.
AHCI	Advanced Host Controller Interface (AHCI) is a SATA Host controller register-level interface.
ATA	The Advanced Technology Attachment (ATA) interface connects storage devices including hard disks and CD-ROM drives to a computer.
APM	The Advanced Power Management (APM) application program interface (API) enables the inclusion of power management in the BIOS.
ARMD	An ATAPI Removable Media Device (ARMD) is any ATAPI device that supports removable media, besides CD and DVD drives.
ASKIR	Amplitude Shift Keyed Infrared (ASKIR) is a form of modulation that represents a digital signal by varying the amplitude (“volume”) of the signal. A low amplitude signal represents a binary 0, while a high amplitude signal represents a binary 1.
BIOS	The Basic Input/Output System (BIOS) is firmware that is first run when the computer is turned on and can be configured by the end user
CODEC	The Compressor-Decompressor (CODEC) encodes and decodes digital audio data on the system.
CMOS	Complimentary metal-oxide-conductor is a type of integrated circuit used in chips like static RAM and microprocessors.
COM	COM is used to refer to serial ports. Serial ports offer serial communication to expansion devices. The serial port on a personal

KINO-DH810

	computer is usually a male DE-9 connector.
DAC	The Digital-to-Analog Converter (DAC) converts digital signals to analog signals.
DDR	Double Data Rate refers to a data bus transferring data on both the rising and falling edges of the clock signal.
DMA	Direct Memory Access (DMA) enables some peripheral devices to bypass the system processor and communicate directly with the system memory.
DIMM	Dual Inline Memory Modules are a type of RAM that offer a 64-bit data bus and have separate electrical contacts on each side of the module.
EHCI	The Enhanced Host Controller Interface (EHCI) specification is a register-level interface description for USB 2.0 Host Controllers.
GbE	Gigabit Ethernet (GbE) is an Ethernet version that transfers data at 1.0 Gbps and complies with the IEEE 802.3-2005 standard.
GPIO	General purpose input
IrDA	Infrared Data Association (IrDA) specify infrared data transmission protocols used to enable electronic devices to wirelessly communicate with each other.
L1 Cache	The Level 1 Cache (L1 Cache) is a small memory cache built into the system processor.
L2 Cache	The Level 2 Cache (L2 Cache) is an external processor memory cache.
LVDS	Low-voltage differential signaling (LVDS) is a dual-wire, high-speed differential electrical signaling system commonly used to connect LCD displays to a computer.
MAC	The Media Access Control (MAC) protocol enables several terminals or network nodes to communicate in a LAN, or other multipoint networks.

PCIe	PCI Express (PCIe) is a communications bus that uses dual data lines for full-duplex (two-way) serial (point-to-point) communications between the SBC components and/or expansion cards and the SBC chipsets. Each line has a 2.5 Gbps data transmission rate and a 250 MBps sustained data transfer rate.
POST	The Power-on Self Test (POST) is the pre-boot actions the system performs when the system is turned-on.
QVGA	Quarter Video Graphics Array (QVGA) refers to a display with a resolution of 320 x 240 pixels.
RAM	Random Access Memory (RAM) is a form of storage used in computer. RAM is volatile memory, so it loses its data when power is lost. RAM has very fast data transfer rates compared to other storage like hard drives.
SATA	Serial ATA (SATA) is a serial communications bus designed for data transfers between storage devices and the computer chipsets. The SATA bus has transfer speeds up to 1.5 Gbps and the SATA 3Gb/s bus has data transfer speeds of up to 3.0 Gbps.
S.M.A.R.T	Self Monitoring Analysis and Reporting Technology (S.M.A.R.T) refers to automatic status checking technology implemented on hard disk drives.
UART	Universal Asynchronous Receiver-transmitter (UART) is responsible for asynchronous communications on the system and manages the system's serial communication (COM) ports.
UHCI	The Universal Host Controller Interface (UHCI) specification is a register-level interface description for USB 1.1 Host Controllers.
USB	The Universal Serial Bus (USB) is an external bus standard for interfacing devices. USB 1.1 supports 12Mbps data transfer rates, while

KINO-DH810

USB 2.0 supports 480Mbps data transfer rates.

VGA

The Video Graphics Array (VGA) is a graphics display system developed by IBM.

Appendix

D

Digital I/O Interface

D.1 Introduction

The DIO connector on the KINO-DH810 is interfaced to GPIO ports on the Super I/O chipset. The DIO has both 8-bit digital inputs and 8-bit digital outputs. The digital inputs and digital outputs are generally control signals that control the on/off circuit of external devices or TTL devices. Data can be read or written to the selected address to enable the DIO functions.



NOTE:

For further information, please refer to the datasheet for the Super I/O chipset.

The BIOS interrupt call **INT 15H** controls the digital I/O.

INT 15H:

AH – 6FH	
<u>Sub-function:</u>	
AL – 8	: Set the digital port as INPUT
AL	: Digital I/O input value

D.2 Assembly Language Sample 1

```
MOV     AX, 6F08H      ;setting the digital port as input
INT     15H           ;
```

AL low byte = value

AH – 6FH	
<u>Sub-function:</u>	
AL – 9	: Set the digital port as OUTPUT
BL	: Digital I/O input value

D.3 Assembly Language Sample 2

```
MOV     AX, 6F09H      ;setting the digital port as output
MOV     BL, 09H        ;digital value is 09H
INT     15H           ;
```

Digital Output is 1001b

Appendix

E

Watchdog Timer

**NOTE:**

The following discussion applies to DOS environment. IEI support is contacted or the IEI website visited for specific drivers for more sophisticated operating systems, e.g., Windows and Linux.

The Watchdog Timer is provided to ensure that standalone systems can always recover from catastrophic conditions that cause the CPU to crash. This condition may have occurred by external EMI or a software bug. When the CPU stops working correctly, Watchdog Timer either performs a hardware reset (cold boot) or a Non-Maskable Interrupt (NMI) to bring the system back to a known state.

A BIOS function call (INT 15H) is used to control the Watchdog Timer:

INT 15H:

AH – 6FH Sub-function:	
AL – 2:	Sets the Watchdog Timer's period.
BL:	Time-out value (Its unit-second is dependent on the item "Watchdog Timer unit select" in CMOS setup).

Table E-1: AH-6FH Sub-function

Call sub-function 2 to set the time-out period of Watchdog Timer first. If the time-out value is not zero, the Watchdog Timer starts counting down. While the timer value reaches zero, the system resets. To ensure that this reset condition does not occur, calling sub-function 2 must periodically refresh the Watchdog Timer. However, the Watchdog timer is disabled if the time-out value is set to zero.

A tolerance of at least 10% must be maintained to avoid unknown routines within the operating system (DOS), such as disk I/O that can be very time-consuming.

**NOTE:**

When exiting a program it is necessary to disable the Watchdog Timer, otherwise the system resets.

Example program:

; INITIAL TIMER PERIOD COUNTER

;

W_LOOP:

MOV AX, 6F02H ;setting the time-out value

MOV BL, 30H ;time-out value is 48 seconds

INT 15H

;

; ADD THE APPLICATION PROGRAM HERE

;

CMP EXIT_AP, 1 ;is the application over?

JNE W_LOOP ;No, restart the application

MOV AX, 6F02H ;disable Watchdog Timer

MOV BL, 0 ;

INT 15H

;

; EXIT ;

Appendix

F

Hazardous Materials Disclosure

F.1 Hazardous Material Disclosure Table for IPB Products Certified as RoHS Compliant Under 2002/95/EC Without Mercury

The details provided in this appendix are to ensure that the product is compliant with the Peoples Republic of China (China) RoHS standards. The table below acknowledges the presences of small quantities of certain materials in the product, and is applicable to China RoHS only.

A label will be placed on each product to indicate the estimated “Environmentally Friendly Use Period” (EFUP). This is an estimate of the number of years that these substances would “not leak out or undergo abrupt change.” This product may contain replaceable sub-assemblies/components which have a shorter EFUP such as batteries and lamps. These components will be separately marked.

Please refer to the table on the next page.

Part Name	Toxic or Hazardous Substances and Elements					
	Lead (Pb)	Mercury (Hg)	Cadmium (Cd)	Hexavalent Chromium (CR(VI))	Polybrominated Biphenyls (PBB)	Polybrominated Diphenyl Ethers (PBDE)
Housing	<input type="radio"/>	<input type="radio"/>	<input type="radio"/>	<input type="radio"/>	<input type="radio"/>	<input type="radio"/>
Display	<input type="radio"/>	<input type="radio"/>	<input type="radio"/>	<input type="radio"/>	<input type="radio"/>	<input type="radio"/>
Printed Circuit Board	<input type="radio"/>	<input type="radio"/>	<input type="radio"/>	<input type="radio"/>	<input type="radio"/>	<input type="radio"/>
Metal Fasteners	<input type="radio"/>	<input type="radio"/>	<input type="radio"/>	<input type="radio"/>	<input type="radio"/>	<input type="radio"/>
Cable Assembly	<input type="radio"/>	<input type="radio"/>	<input type="radio"/>	<input type="radio"/>	<input type="radio"/>	<input type="radio"/>
Fan Assembly	<input type="radio"/>	<input type="radio"/>	<input type="radio"/>	<input type="radio"/>	<input type="radio"/>	<input type="radio"/>
Power Supply Assemblies	<input type="radio"/>	<input type="radio"/>	<input type="radio"/>	<input type="radio"/>	<input type="radio"/>	<input type="radio"/>
Battery	<input type="radio"/>	<input type="radio"/>	<input type="radio"/>	<input type="radio"/>	<input type="radio"/>	<input type="radio"/>

O: This toxic or hazardous substance is contained in all of the homogeneous materials for the part is below the limit requirement in SJ/T11363-2006

X: This toxic or hazardous substance is contained in at least one of the homogeneous materials for this part is above the limit requirement in SJ/T11363-2006

KINO-DH810

此附件旨在确保本产品符合中国 RoHS 标准。以下表格标示此产品中某有毒物质的含量符合中国 RoHS 标准规定的限量要求。

本产品上会附有“环境友好使用期限”的标签，此期限是估算这些物质“不会有泄漏或突变”的年限。本产品可能包含有较短的环境友好使用期限的可替换元件，像是电池或灯管，这些元件将会单独标示出来。

部件名称	有毒有害物质或元素					
	铅 (Pb)	汞 (Hg)	镉 (Cd)	六价铬 (CR(VI))	多溴联苯 (PBB)	多溴二苯醚 (PBDE)
壳体	O	O	O	O	O	O
显示	O	O	O	O	O	O
印刷电路板	O	O	O	O	O	O
金属螺帽	O	O	O	O	O	O
电缆组装	O	O	O	O	O	O
风扇组装	O	O	O	O	O	O
电力供应组装	O	O	O	O	O	O
电池	O	O	O	O	O	O

O: 表示该有毒有害物质在该部件所有物质材料中的含量均在 SJ/T11363-2006 标准规定的限量要求以下。
X: 表示该有毒有害物质至少在该部件的某一均质材料中的含量超出 SJ/T11363-2006 标准规定的限量要求。