

USER'S MANUAL

tBOX500-510-FL Series

Embedded Systems

User's Manual



www.axiomtek.com

Disclaimers

This manual has been carefully checked and believed to contain accurate information. Axiomtek Co., Ltd. assumes no responsibility for any infringements of patents or rights of any third party, and any liability arising from such use.

Axiomtek does not warrant or assume any legal liability or responsibility for the accuracy, completeness or usefulness of any information in this document. Axiomtek does not make any commitment to update the information in this manual.

Axiomtek reserves the right to change or revise this document and/or product at any time without notice.

No part of this document may be reproduced, stored in a retrieval system, or transmitted, in any form or by any means, electronic, mechanical, photocopying, recording, or otherwise, without the prior written permission of Axiomtek Co., Ltd.

©Copyright 2021 Axiomtek Co., Ltd.
All Rights Reserved
May 2021, Version A3
Printed in Taiwan

Safety Precautions

Before getting started, please read the following important safety precautions.

1. User should not modify any unmentioned jumper setting without Axiomtek FAE's instruction. Any modification without instructions might damage the system.
2. The tBOX500-510-FL does not come equipped with an operating system. An operating system must be loaded first before installing any software into the computer.
3. Be sure to ground yourself to prevent static charge when installing the internal components. Use a grounding wrist strap and place all electronic components in any static-shielded devices. Most electronic components are sensitive to static electrical charge.
4. Disconnect the power cord from the tBOX500-510-FL before making any installation. Be sure both the system and the external devices are turned OFF. Sudden surge of power could ruin sensitive components. Make sure the tBOX500-510-FL is properly grounded.
5. Make sure the voltage of the power source is correct before connecting the equipment to the power outlet.
6. Turn OFF the system power before cleaning. Clean the system using a cloth only. Do not spray any liquid cleaner directly onto the screen.
7. Do not leave this equipment in an uncontrolled environment where the storage temperature is below -40°C or above 85°C . It may damage the equipment.
8. Do not open the system's back cover. If opening the cover for maintenance is a must, only a trained technician is allowed to do so. Integrated circuits on computer boards are sensitive to static electricity. To avoid damaging chips from electrostatic discharge, observe the following precautions:
 - Before handling a board or integrated circuit, touch an unpainted portion of the system unit chassis for a few seconds. This will help to discharge any static electricity on a human body.
 - When handling boards and components, wear a grounding wrist strap, available from most electronic component stores.

Classification

1. Degree of protection against electric shock: not classified
2. Degree of protection against the ingress of water: IP30
3. Equipment not suitable for use in the presence of a flammable anesthetic mixture with air or with oxygen or nitrous oxide.
4. Mode of operation: Continuous

General Cleaning Tips

You may need the following precautions before you begin to clean the computer. When you clean any single part or component for the computer, please read and understand the details below fully.

When you need to clean the device, please rub it with a piece of dry cloth.

1. Be cautious of the tiny removable components when you use a vacuum cleaner to absorb the dirt on the floor.
2. Turn the system off before you start to clean up the component or computer.
3. Never drop the components inside the computer or get circuit board damp or wet.
4. Be cautious of all kinds of cleaning solvents or chemicals when you use it for the sake of cleaning. Some individuals may be allergic to the ingredients.
5. Try not to put any food, drink or cigarette around the computer.

Cleaning Tools:

Although many companies have created products to help improve the process of cleaning your computer and peripherals users can also use household items to clean their computers and peripherals. Below is a listing of items you may need or want to use while cleaning your computer or computer peripherals.

Keep in mind that some components in your computer may only be cleaned using a product designed for cleaning the same types of components. Please read the instructions that come with a cleaning product to avoid misuse.

- Cloth: A piece of cloth is the best tool to use when rubbing up a component. Although paper towels or tissues can be used on most hardware as well, we still recommend using a piece of cloth to rub hardware parts.
- Water or rubbing alcohol: You may moisten a piece of cloth a bit with some water or rubbing alcohol and rub it on the computer. Unknown solvents may be harmful to the plastics parts.
- Vacuum cleaner: Using a vacuum cleaner to suck dust, dirt, hair, cigarette particles, and other particles out of a computer can be one of the best methods of cleaning a computer. Over time these items can restrict the airflow in a computer and cause the circuitry to corrode.
- Cotton swabs: Cotton swabs moistened with rubbing alcohol or water are excellent tools for wiping hard-to-reach areas in your keyboard, mouse, and other locations.
- Foam swabs: Whenever possible it is better to use lint-free swabs such as foam swabs.



NOTE: We strongly recommend that you should shut down the system before you start to clean any single component.

Please follow the steps below:

1. Close all application programs
2. Close operating software
3. Turn off power switch
4. Remove all devices
5. Pull out the power cable

Scrap Computer Recycling

Please inform the nearest Axiomtek distributor as soon as possible for suitable solutions in case computers require maintenance or repair; or for recycling in case computers are out of order or no longer in use.

Trademarks Acknowledgments

Axiomtek is a trademark of Axiomtek Co., Ltd.

Windows® is a trademark of Microsoft Corporation.

AMI® is a registered trademark of American Megatrends Inc.

IBM, PC/AT, PS/2, VGA are trademarks of International Business Machines Corporation.

Intel® and Atom™ are trademarks of Intel Corporation.

Winbond is a trademark of Winbond Electronics Corp.

Other brand names and trademarks are the properties and registered brands of their respective owners.

Table of Contents

Safety Precautions	iii
Classification	iv
SECTION 1 INTRODUCTION.....	1
1.1 General Description	1
1.2 System Specifications	2
1.2.1 CPU	2
1.2.2 System I/O	2
1.2.3 System Specification.....	2
1.3 Dimensions	4
1.4 I/O Outlets.....	6
1.5 Packing List.....	7
SECTION 2 HARDWARE INSTALLATION	9
2.1 Installing the Swappable HDD/SSD & Value-added Module (VAM). 9	
2.2 Installing the DDR module and Express Mini Card.....	10
SECTION 3 CONNECTOR	15
3.1 Connectors	15
3.1.1 DVI Connector	15
3.1.2 Serial Port Connector	16
3.1.3 USB3.0 Stack Ports	16
3.1.4 LED Indicators.....	17
3.1.5 DC Power Input Connector	17
3.1.6 LAN Connector (LAN1~ LAN4)	18
3.1.7 SIM Card Connector	18
3.1.8 PCI-Express Mini Card Connector	19
3.1.9 Antenna Opening	20
3.1.10 HDD Tray Locker	20
3.1.11 Remote Switch Connector.....	20
3.1.12 Value-Added Module Specification	21
SECTION 4 AMI BIOS SETUP UTILITY	23
4.1 Starting	23
4.2 Navigation Keys	24
4.3 Main Menu	25
4.4 Advanced Menu	26
4.5 Chipset Menu	35
4.6 Security Menu	37
4.7 Boot Menu	38
4.8 Save & Exit Menu	39
APPENDIX A WATCHDOG TIMER	41

This page is intentionally left blank.

SECTION 1 INTRODUCTION

This chapter contains general information and detailed specifications of the tBOX500-510-FL. Chapter 1 includes the following sections:

- General Description
- System Specification
- Dimensions
- I/O Outlets
- Package List

1.1 General Description

The tBOX500-510-FL is an embedded system that supports the 7th Gen. Intel® Celeron - 3965U / Core™ i3-7100U / i5-7300U / i7-7600U processor (2.2 up to 2.8 GHz) onboard. It is compatible with Windows® 10 and Linux and has been optimized for the most durable operation. It also features fanless design with rich I/O, supports SO-DIMM up to 32GB, and delivers enhanced system reliability by including a built-in Watchdog Timer.

● Features

- 7th Generation Intel® Core™ i (15W) processor onboard
- Support SO-DIMM DDR4-2133 up to 32GB
- CE, EN 50155, fire protection of vehicles Europe standard PrCEN TS 45545-2, IEC 60945 certified. DNV 2.4 compliance
- Fanless with operating temperature range from -40°C to +70°C with W.T. SSD
0°C to +60°C with HDD
-40°C to +70°C with VAM701/703/705/707 (internal PoE PSU, refers to NOTE1, NOTE2)
- 1 COM Port RS-232/422/485.
- Supports USB 3.0 and SATA3
- 2x removable & lockable 2.5" SATA drive bays.
- 3x internal mini PCIe slot and 2x SIM socket
- Supports 1 Port 10/100/1000 Base-T Ethernet LAN connectors



NOTE1: NOTE1: -40 °C to +55 °C with Max consumption, POE budget 60W@24VDC; PoE budget 90W@36-110VDC

NOTE2: -40°C 0 to +70°C with SDP application, SDP condition, POE port all use IPCAM, and use software for recording and live-view, without additional testing software to occupy CPU resources

**** SDP refers to "scenario design power"**

● Reliable and Stable Design

- The tBOX500-510-FL adopts an advanced cooling system and supports mSATA, which makes it especially suitable for vibration environments and the best solution for industrial automation, digital signage, and gaming applications.

- **Embedded O/S Supported**

- The tBOX500-510-FL supports not only Windows® 10 but also embedded O/S, such as Windows® 10 Embedded and Linux. For storage devices, the tBOX500-510-FL supports 2x 2.5" SATA drive bays and 1x mSATA slot.

1.2 System Specifications

1.2.1 CPU

- **CPU**

- Onboard Intel® Core™ Celeron 3965U / Core™ i3-7100U / i5-7300U / i7-7600U processor (2.2 up to 2.8 GHz) processor (2M / 3M Cache 2.2GHz up to 2.8 GHz)

- **BIOS**

- American Megatrends Inc. BIOS.
- "Load Optimized Default" to backup customized Settings in the BIOS flash chip to prevent CMOS battery fail.

- **System Memory**

- DDR4 SO-DIMM socket up to DDR4-2133 Memory

- **Graphics**

- Integrated Intel® HD Graphics 620 for DVI-I

1.2.2 System I/O

- **Front Side**

- 1x DVI-I Female Connector
- 2x Screw Audio Connectors (MIC-IN/LINE-OUT)
- 1x RJ-45 10/100/1000 Mbps Ethernet
- 4x USB 3.0
- 1x DB9 serial console for RS232/422/485
- 1x Remote Power Switch
- 1x Reset Button

- **Rear Side**

- 1 x M12 or terminal block DC-in (optional)
- 4x Antenna Opening
- 1 x PoE Power Supply Input (optional)
- 2 x modular IO slot (for value-added module)

1.2.3 System Specification

- **Watchdog Timer**

- Reset supported; 255 levels, 1~255 sec.

- **Power Supply**

- 24-110 VDC-in power supply
- Power Rate:3A@24VDC; 0.65A@110VDC
- Power Rate:6A@24VDC (W/ PSU)

- Power Rate:5.5A@24VDC; 1.6A@110VDC (For internal PoE PSU SKU)
- **Operation Temperature**
 - -40°C to +70°C (-40°F to 158°F) with W.T. SSD
 - 0°C to +60°C (+32°F to +140°F) with HDD
 - -40°C to +70°C (- 40 °F to **158°F**) with VAM701/703/705/707 (with internal PoE PSU)
- **Storage Temperature**
 - -40°C ~ +85°C (- 40°F ~ 176°F)
- **Humidity**
 - 5% ~ 95% (non-condensation)
- **Vibration Endurance**
 - 3Grms w/ SSD (5 ~ 500Hz, X, Y, Z direction; random)
 - 1.5Grms w/ HDD (5 ~ 500Hz, X, Y, Z direction; random)
- **Weight**
 - 3.5 kg (7.72lb) without package
 - 4.5kg (11.02lb) with package
- **Dimensions**
 - 321mm(12.64")(W) x 210.2mm(8.28")(D) x 73.3mm(2.89")(H)



NOTE: All specifications and images are subject to change without notice.

1.3 Dimensions

The following diagrams show the dimensions and outlines of the tBOX500-510-FL.

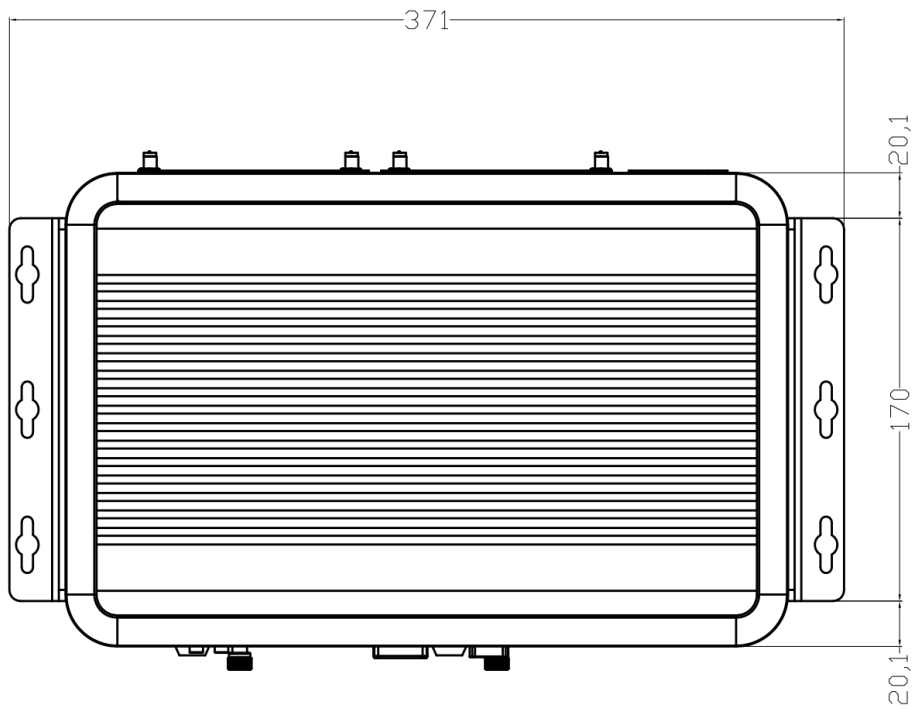

▲ Top View

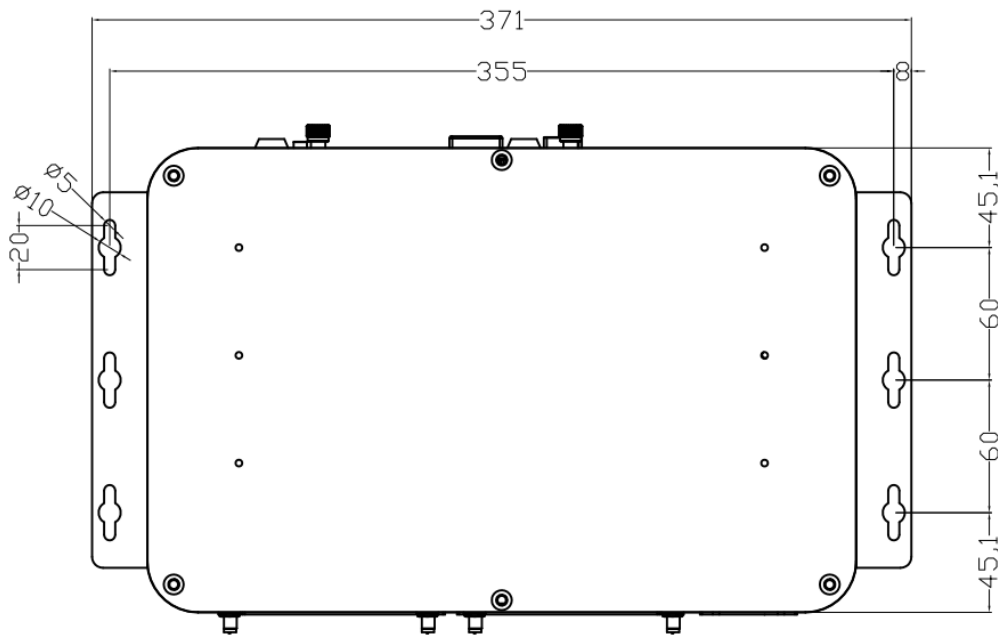

▲ Bottom View

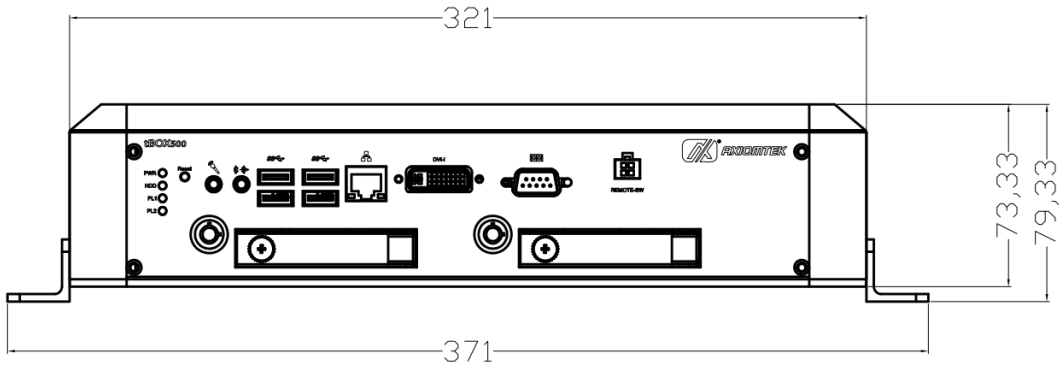

▲ Front View

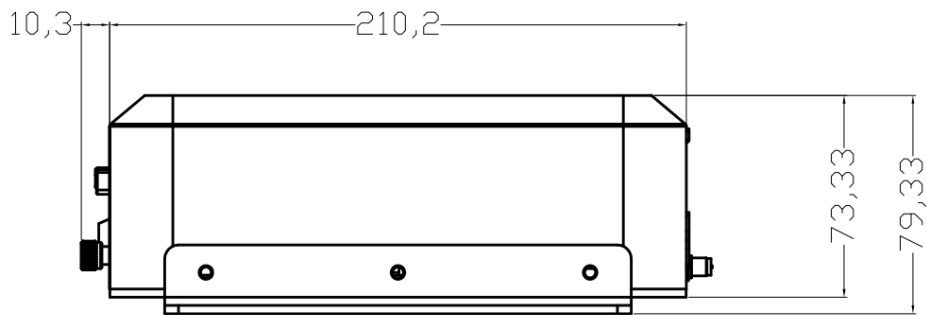

▲ Side View

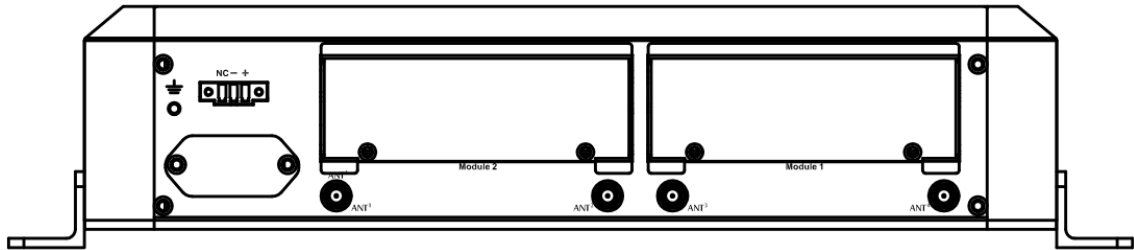

▲ Rear View: Terminal block DC-IN (w/o VAM)

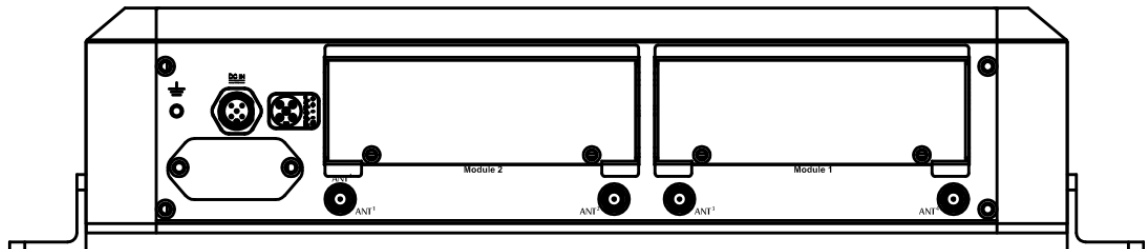

▲ Rear View: M12 DC-IN (w/o VAM)

▲ Rear View: M12 DC-IN (w/ **VAM701/703/705/707**)

1.4 I/O Outlets

The following figures show the I/O outlets on the front and rear views of the tBOX500-510-FL.

- **Front View**



- **Rear View**



1.5 Packing List

The package bundled with your tBOX500-510-FL should contain the following items:

- **tBOX500-510-FL System Unit x 1**
- **Screw pack x 1**
- **Foot pad x 4**
- **Wall-mount bracket x 1**
- **Power terminal block or M12 power cable x 1 (optional)**
- **Remote switch cable x1(optional)**
- **HDD/SSD (optional)**
- **mSATA (optional)**
- **Express Mini Card module (optional)**
- **3G/4G/GPS module x 1 (optional)**
- **Wi-Fi/Bluetooth module x 1 (optional)**
- **Value-added module x 2 (maximum, optional)**

If you cannot find this package or any of the above-mentioned items is missing, please contact your local distributor immediately.

This page is intentionally left blank.

SECTION 2 HARDWARE INSTALLATION

The tBOX500-510-FL is designed for easy hardware configurations, such as the HDD (Hard Disk Drive), DRAM and mini PCIe card. Chapter 2 will show you how to install the hardware.

2.1 Installing the Swappable HDD/SSD & Value-added Module (VAM)

Step 1 Attach a piece of Mylar on the back of an HDD/SSD as shown.



Step 2 As shown in the picture, slide the HDD/SSD into the SATA tray. Insert screws into each side of the SATA drive through the corresponding holes.



Step 3 Install the SATA drive into the slot and lock the SATA drive to complete the installation



- Step 4** Unscrew the top side screws (x4) and rear side screws (x2), and then remove the module slot cover.

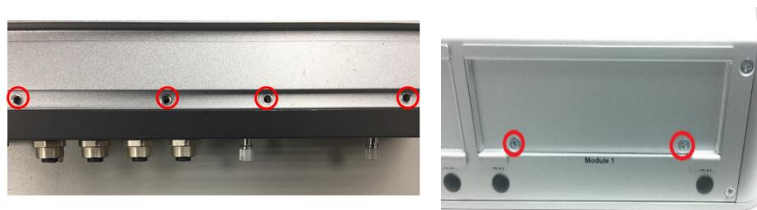

- Step 5** Insert the value-added module (VAM) as shown below. Make sure the module is on the track and slide the module gently into the slot until it clicks in place. Secure the module with the screws.

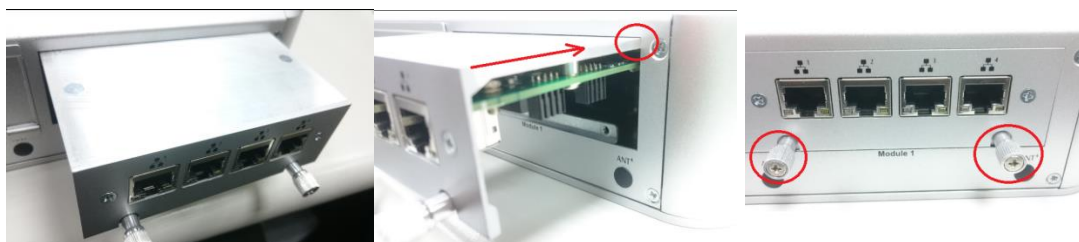

2.2 Installing the DDR module and Express Mini Card

- Step 1** Make sure system power is off and unplug the power cord.
- Step 2** Turn the tBOX500-510-FL upside down, loosen the cover screws and lift the bracket a little bit as shown.



- Step 3** Disconnect the four SATA connectors and remove the bracket



Step 4 Loosen below screws to remove the DDR bracket and put the thermal pad on the slot.



Step 4-1 For internal PSU PoE SKU, Loosen below screws (8 pcs) to remove the cap-board, DDR bracket and put the thermal pad on the slot.

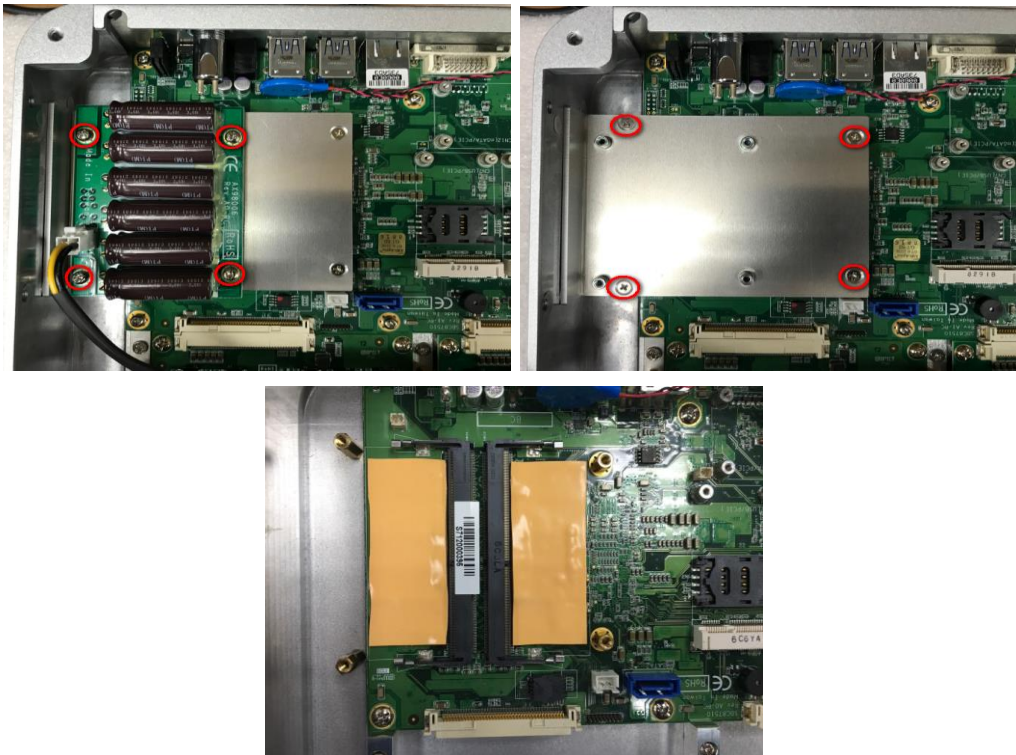

Step 5 Install the DDR module with caution and put the thermal pad on the DDR module again.



Installing the Express Mini card:

Step 1 Slide a SIM or Mini card into their respective slot with caution.



Step 2 Fasten the screws to complete the installation.



For the Value-added modules

Model name	Specification	Note
VAM700	4 x M12 A-coded GbE	
VAM701	4 x M12 A-coded GbE (PoE/PoE+)	1.With external PSU 2.Support internal PoE PSU
VAM702	4 x RJ-45 GbE	
VAM703	4 x RJ-45 GbE (PoE/PoE+)	1.With external PSU 2.Support internal PoE PSU
VAM704	4 x M12 D-coded GbE	
VAM705	4 x M12 D-coded GbE (PoE/PoE+)	1.With external PSU 2.Support internal PoE PSU
VAM706	4 x M12 X-coded GbE	
VAM707	4 x M12 X-coded GbE (PoE/PoE+)	1.With external PSU 2.Support internal PoE PSU
VAM100	4 x 4-wire isolated RS-232/422/485	
VAM101	4 x isolated CANbus 2.0A/B	
VAM200	8-in/8-out isolated DIO	
VAM400	Video & Audio-in + 1x PCI Express Mini Card slot + 2x SIM Card slot + 1x capture card	
VAM600	2x PCI Express Mini Card slot + 2x SIM Card slot	
VAM900	2x PCI Express Mini Card slot + 2x SIM Card slot 1x Half-PCI Express Mini Card slot + (only PCIe) 1 x isolated CANbus 2.0A/B 1 x 4-wire isolated RS-232/422/485 1 x 8-in/8-out isolated DIO	

For the External Power Supply Unit

Model name	Spec	Note
PSU120-259	Power Supply output 53V	24VDC input only

This page is intentionally left blank.

SECTION 3 CONNECTOR

3.1 Connectors

Connectors connect the CPU board with the other parts of the system. Loose or improper connection might cause problems. Make sure all connectors are properly and firmly connected before your turn on the system.

3.1.1 DVI Connector

DVI-I

Pin	Signal	Pin	Signal
1	TMDS Data 2-	2	TMDS Data 2+
3	GND	4	CRT_SPD_Clock
5	CRT_SPD_Data	6	DVI_SPD_Clock
7	DVI_SPD_Data	8	Analog Vsync
9	TMDS Data 1-	10	TMDS Data 1+
11	GND	12	N.C
13	N.C.	14	+5V
15	GND	16	Hot Plug Detect
17	TMDS Data 0-	18	TMDS Data 0+
19	GND	20	N.C
21	N.C	22	GND
23	TMDS Clock+	24	TMDS Clock-
C1	Analog RED	C2	Analog Green
C3	Analog Blue	C4	Analog Hsync
C5	GND		

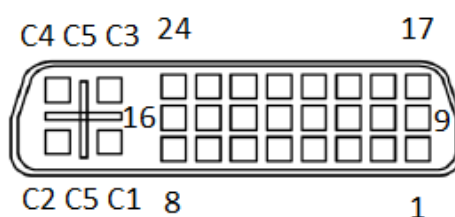

3.1.2 Serial Port Connector

The COM1 port connector is a DB9 connector. The pin assignment of RS-232/RS-422/RS-485 is listed in the following table. If you need a COM port to support RS-422 or RS-485, please set it up in BIOS settings.

Pin	RS-232	RS-422	RS-485
1	DCD, Data carrier detect	TX-	Data-
2	RXD, Receive data	TX+	Data+
3	TXD, Transmit data	RX+	NC
4	DTR, Data terminal ready	RX-	NC
5	GND, ground	GND, ground	GND, ground
6	DSR, Data set ready	NC	NC
7	RTS, Request to send	NC	NC
8	CTS, Clear to send	NC	NC
9	RI, Ring indicator	NC	NC
10	NC	NC	NC

COM

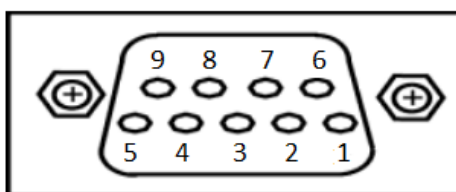

3.1.3 USB3.0 Stack Ports

Pin	Signal USB Port 0	Pin	Signal USB Port 1
1	USB_VCC (+5V level standby power)	10	USB_VCC (+5V level standby power)
2	USB_Data2-	11	USB_Data3-
3	USB_Data2+	12	USB_Data3+
4	GND	13	GND
5	SSRX2-	14	SSRX3-
6	SSRX2+	15	SSRX3+
7	GND	16	GND
8	SSTX2-	17	SSTX3-
9	SSTX2+	18	SSTX3+

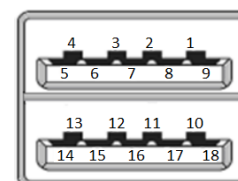

3.1.4 LED Indicators

LED Indicator	Function
PWR/ Green	Power on
HDD/ Blue	HDD activity
PL1/ Green	Programmable
PL2/ Green	Programmable



3.1.5 DC Power Input Connector

The DC-in connector has three pins as shown in the table below.

Pin	Marine/ Railway
1	NC
2	-
3	+



The DC-in power input connector is an M12 A-code Male 5Pin connector.

Pin	Signal
1	VCC
2	VCC
3	System GND
4	System GND
5	Chassis GND

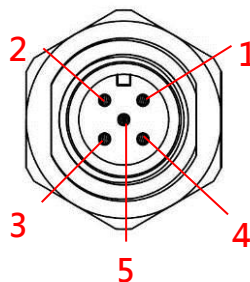

The DC-in connector has four pins as shown in the table below (W/ PSU-120)

Pin	PoE Power
1	VCC
2	System GND
3	NC
4	NC

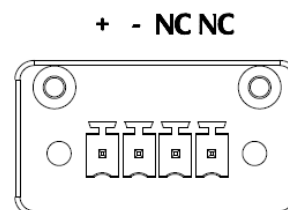

3.1.6 LAN Connector (LAN1~ LAN4)

The RJ-45 LAN connectors can support 10/100/1000Mbps

Ethernet (optional)

Pin	Description	10/100Base-T	1000Base-T
1	Transmit Data+ or Bidirectional	TX+	BI_DA+
2	Transmit Data- or Bidirectional	TX-	BI_DA-
3	Receive Data+ or Bidirectional	RX+	BI_DB+
4	Not Connected or Bidirectional	N.C.	BI_DC+
5	Not Connected or Bidirectional	N.C.	BI_DC-
6	Receive Data- or Bidirectional	RX-	BI_DB-
7	Not Connected or Bidirectional	N.C.	BI_DD+
8	Not Connected or Bidirectional	N.C.	BI_DD-
B	Speed LED	OFF/Green	Orange
A	Activity Link LED(Orange)	OFF: No Link Blinking: Data activity detected	

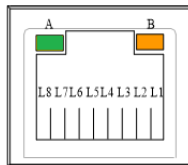

3.1.7 SIM Card Connector

The SIM Card slot is an ISO 7816 standard 6-pin connector for the PCI Express Mini Card.

Pin	Signal
C1	SIM_PWR
C2	SIM_RESET
C3	SIM_CLK
C5	GND
C6	SIM_VPP
C7	SIM_DATA

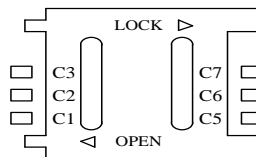

3.1.8 PCI-Express Mini Card Connector

The PCI Express Mini Card connectors support 1x PCI Express lane and 2x USB 2.0 lanes. A PCI Express Mini Card can be applied to either PCI Express or USB 2.0. It's very helpful that we have designed the USB 2.0 and PCI Express lanes in the same slot for an interface migration. We provide a convenient and low-cost solution for you with this friendly design.

Pin	Signal	Pin	Signal
1	WAKE#	2	+3.3VSB
3	N.C.	4	GND
5	N.C.	6	+1.5V
7	CLKREQ#	8	SIM_PWR
9	GND	10	SIM_DATA
11	REFCLK-	12	SIM_CLK
13	REFCLK+	14	SIM_RERST
15	GND	16	SIM_VPP
17	N.C.	18	GND
19	N.C.	20	+3.3VSB
21	GND	22	PERST#
23	PE_RXN4	24	+3.3VSB
25	PE_RXP4	26	GND
27	GND	28	+1.5V
29	GND	30	SMB_CLK
31	PE_TXN4	32	SMB_DATA
33	PE_TXP4	34	GND
35	GND	36	USB_D3-
37	GND	38	USB_D3+
39	+3.3VSB	40	GND
41	+3.3VSB	42	LED_WWAN#
43	GND	44	LED_WLAN#
45	N.C.	46	LED_WPAN#
47	N.C.	48	+1.5V
49	N.C.	50	GND
51	N.C.	52	+3.3VSB

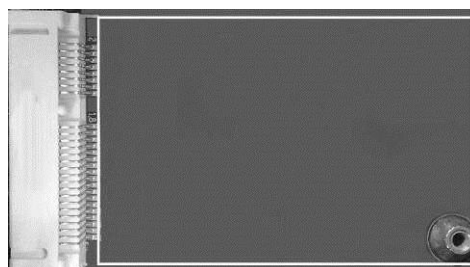
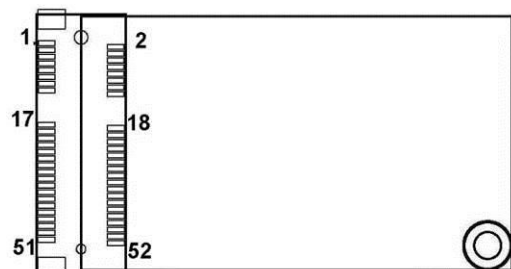



3.1.9 Antenna Opening

Profile opening is reserved for Wi-Fi/3G/4G antennas.

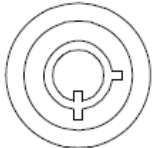

3.1.10 HDD Tray Locker

Lock and secure the swappable HDD/SSD bay.

Status	Diagram
Unlocked	
Locked	

3.1.11 Remote Switch Connector

The remote switch is ideal for a remote button which can act as an ATX power on/off button.







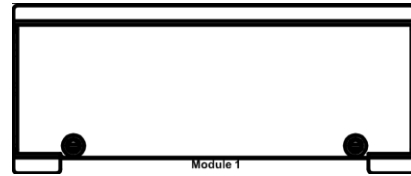

Pin	Signal	Description
1	NC	N/A
2	Switch Signal	Low Active. Act as PC's ATX switch when external switch installed (Pin 3 Active) **Internal pull up resistor did not connect to any power source
3	Ext. SW Sensor	Low Active. To detect external power switch install or not. ** Internal pull up resistor did not connect to any power source
4	GND	



3.1.12 Value-Added Module Specification

Module	Description
1,2	The system offers two expansion I/O module slots to support the functions of the value-added modules (VAM) listed in the table below. For detailed specifications, please refer to the quick manual of the individual module.



Item	Spec& Drawing	Item	Spec& Drawing
#1	VAM700/701: 4x M12 A-coded Gb Ethernet with PoE (optional) 	#2	VAM702/703: 4x RJ-45 Gb Ethernet with PoE (optional) 
#3	VAM100: 4x 4-wire isolated RS-232/422/485 	#4	VAM200: 8-in/8-out isolated DIO 
#5	VAM400: Video & Audio-in + mini PCIe capture card 	#6	VAM101: 4x isolated CANbus 2.0A/B 
#7	VAM600: Mini PCI Express + SIM 	#8	VAM900: Mini PCI Express + SIM, isolated CANbus, RS232/422/485, 8-in/8-out isolated DIO 

This page is intentionally left blank.

SECTION 4

AMI BIOS SETUP UTILITY

This chapter provides users with detailed descriptions of how to set up basic system configuration through the AMI BIOS setup utility.

4.1 Starting

To enter the setup screens, follow the steps as below:

1. Turn on the computer and press the key immediately.
2. After pressing the <Delete> key, the main BIOS setup menu displays. You can access other setup screens from the main BIOS setup menu, such as the Chipset and Power menus.

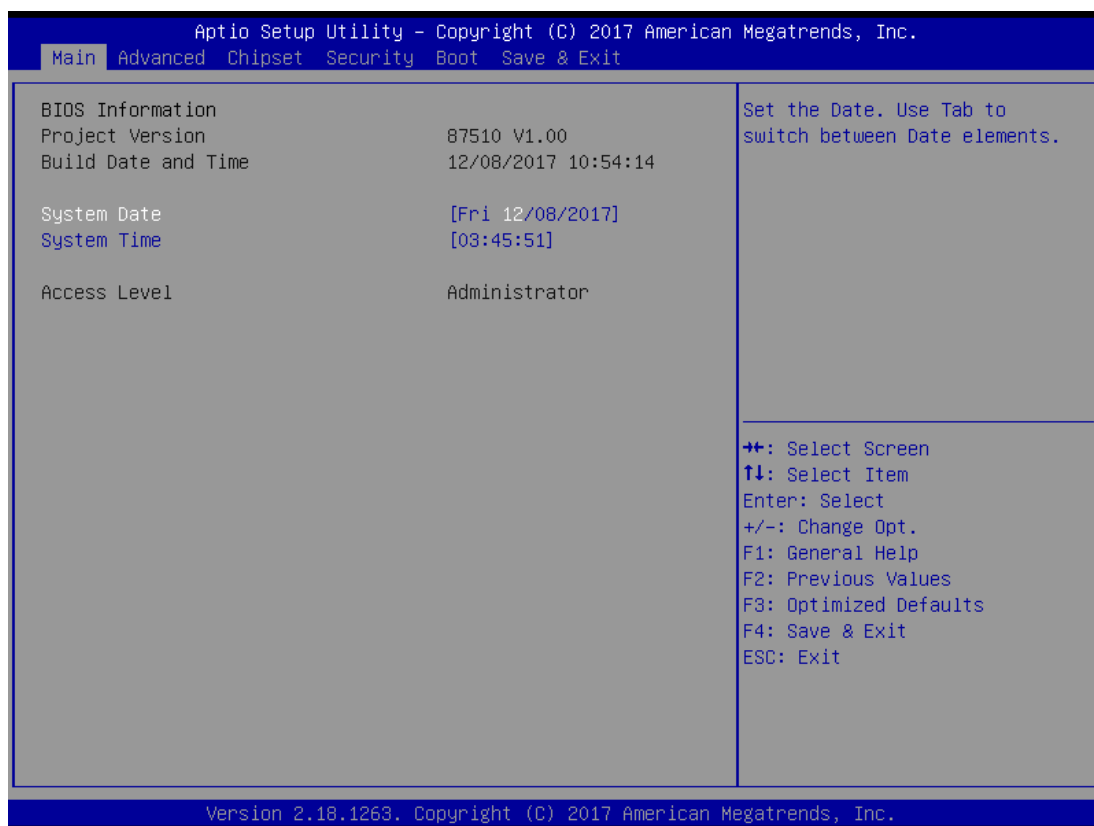

4.2 Navigation Keys

The BIOS setup/utility uses a key-based navigation system called hot keys. Most of the BIOS setup utility hot keys can be used at any time during the setup navigation process. These keys include <F1>, <F10>, <Enter>, <ESC>, <Arrow> keys, and so on.



NOTE: Some of the navigation keys may differ from one screen to another.

Hot Keys	Description
← Left/Right	The Left and Right <Arrow> keys allow you to select a setup screen.
↑↓ Up/Down	The Up and Down <Arrow> keys allow you to select a setup screen or sub-screen.
+– Plus/Minus	The Plus and Minus <Arrow> keys allow you to change the field value of a particular setup item.
Tab	The <Tab> key allows you to select setup fields.
F1	The <F1> key allows you to display the General Help screen.
F10	The <F10> key allows you to save any changes you have made and exit Setup. Press the <F10> key to save your changes.
Esc	The <Esc> key allows you to discard any changes you have made and exit the Setup. Press the <Esc> key to exit the setup without saving your changes.
Enter	The <Enter> key allows you to display or change the setup option listed for a particular setup item. The <Enter> key can also allow you to display the setup sub- screens.

4.3 Main Menu

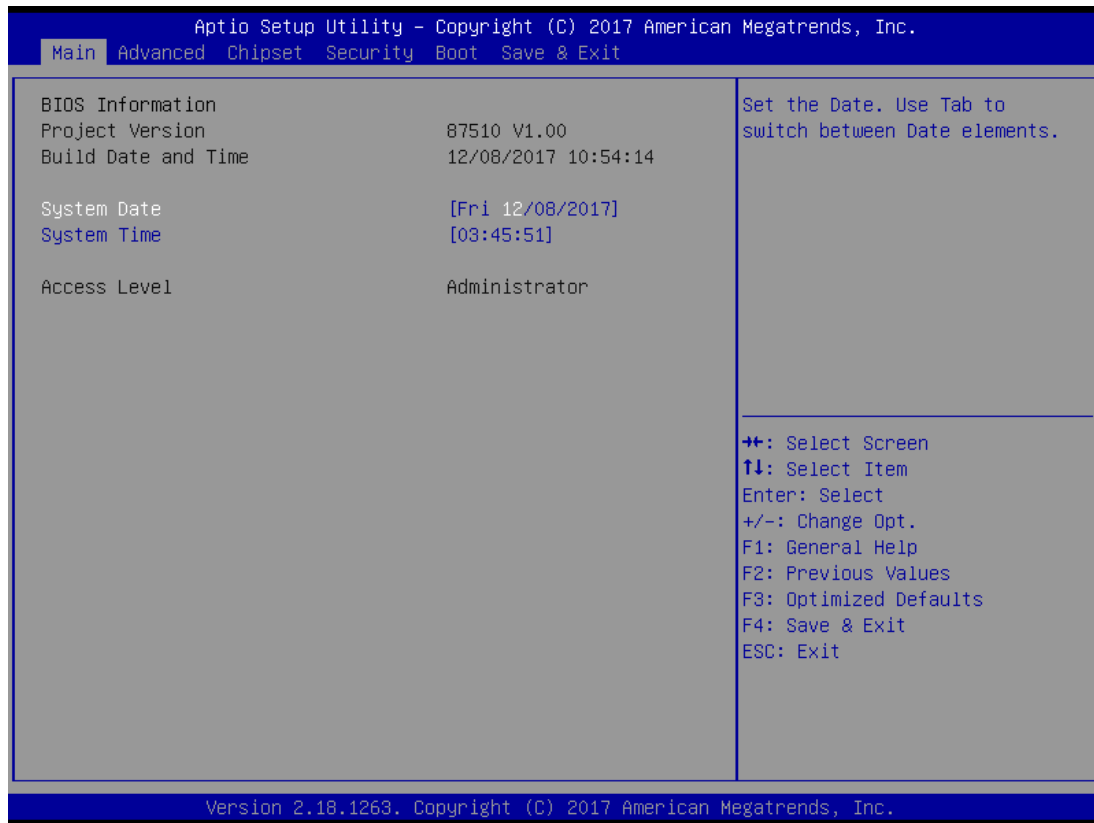

System Time/Date

Use this option to change the system time and date. Highlight System Time or System Date using the <Arrow> keys. Enter new values through the keyboard. Press the <Tab> key or the <Arrow> keys to move between fields. The date must be entered in MM/DD/YY format. The time is entered in HH:MM:SS format.

4.4 Advanced Menu

The Advanced menu allows users to set the configuration of the CPU and other system devices. You can select any of the items in the left frame of the screen to go to the sub menu:

- ▶ MiniCard Switch
- ▶ CPU Configuration
- ▶ SATA And RST Configuration
- ▶ PCH-FW Configuration
- ▶ USB Configuration
- ▶ Serial port Console Redirection
- ▶ F81803 Super IO Configuration
- ▶ Hardware Monitor

For items marked with “▶”, please press <Enter> for more options.

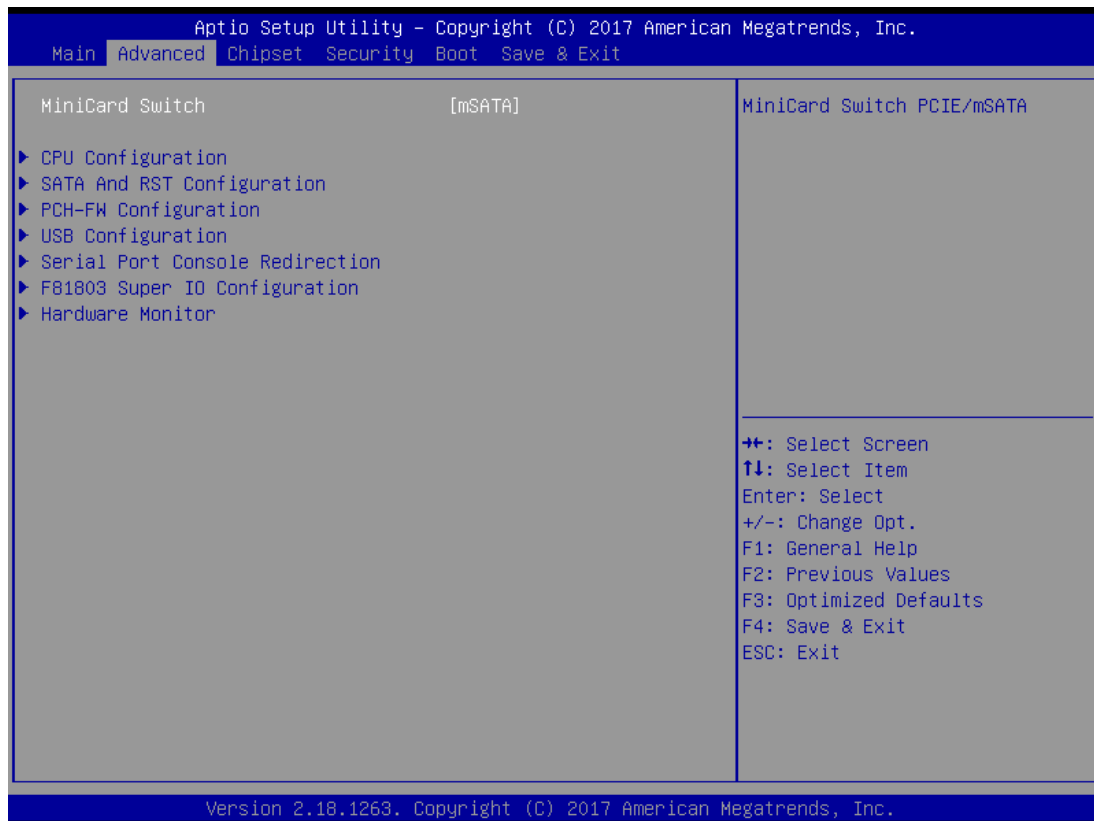

Mini Card Switch

Select the PCIe / mSATA function

CPU Configuration

This screen shows the CPU Configuration.

Aptio Setup Utility - Copyright (C) 2017 American Megatrends, Inc.

Advanced

CPU Configuration		When enabled, a VMM can utilize the additional hardware capabilities provided by Vanderpool Technology.
Type	Intel(R) Celeron(R) CPU 3965U @ 2.20GHz	
ID	0x806E9	
Speed	2200 MHz	
L1 Data Cache	32 KB x 2	
L1 Instruction Cache	32 KB x 2	
L2 Cache	256 KB x 2	
L3 Cache	2 MB	
L4 Cache	N/A	
VMX	Supported	
SMX/TXT	Not Supported	
Intel (VMX) Virtualization Technology	[Enabled]	⇧⇩: Select Screen ⇩⇧: Select Item Enter: Select +/-: Change Opt. F1: General Help F2: Previous Values F3: Optimized Defaults F4: Save & Exit ESC: Exit

Version 2.18.1263. Copyright (C) 2017 American Megatrends, Inc.

SATA Configuration

Set SATA configuration.

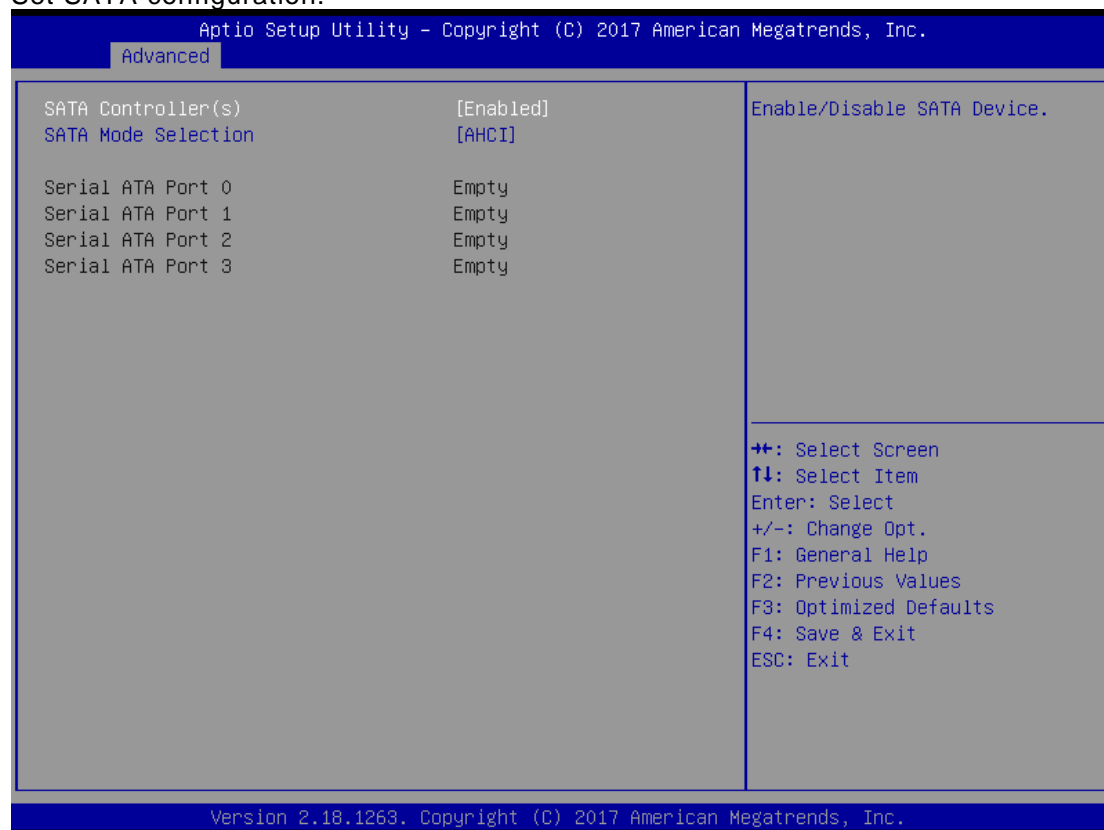

SATA Controller(S)

Enable or disable the integrated SATA controllers. (Default: Enabled)

SATA Mode

Choose the SATA operation mode. Here are the options for your selection.

Serial-ATA Port 0-3

Control the onboard SATA port. Here are the options for your selection, enabled and disabled.

PCH-FW Configuration

Configure Intel(R) Active Management Technology Parameters.

Display ME firmware version and ME firmware SKU.

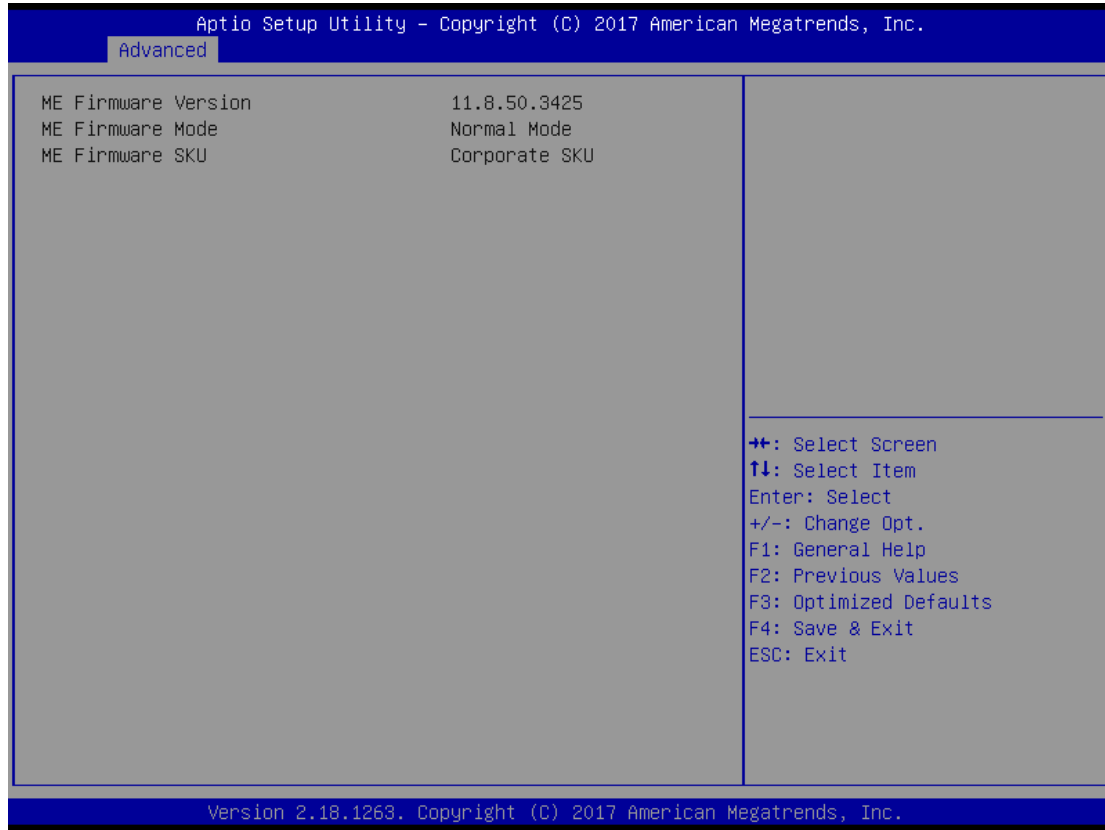

USB Configuration

This screen shows the USB Device.

This is for supporting USB devices on legacy OS. The system will automatically detect any USB device connected to the computer and enable the USB legacy mode.

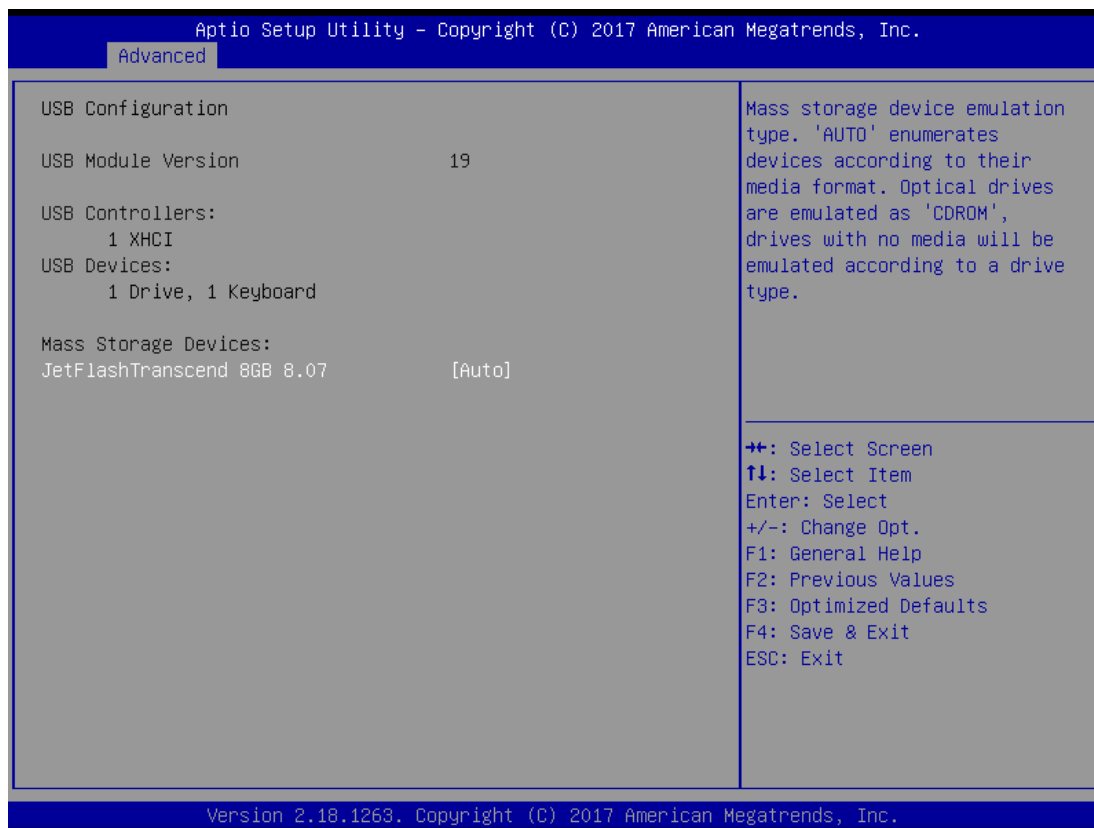

Serial port Console Redirection

The settings specify how the host computer and the remote computer (which the user is using) will exchange data. Both computers should have the same or compatible settings.

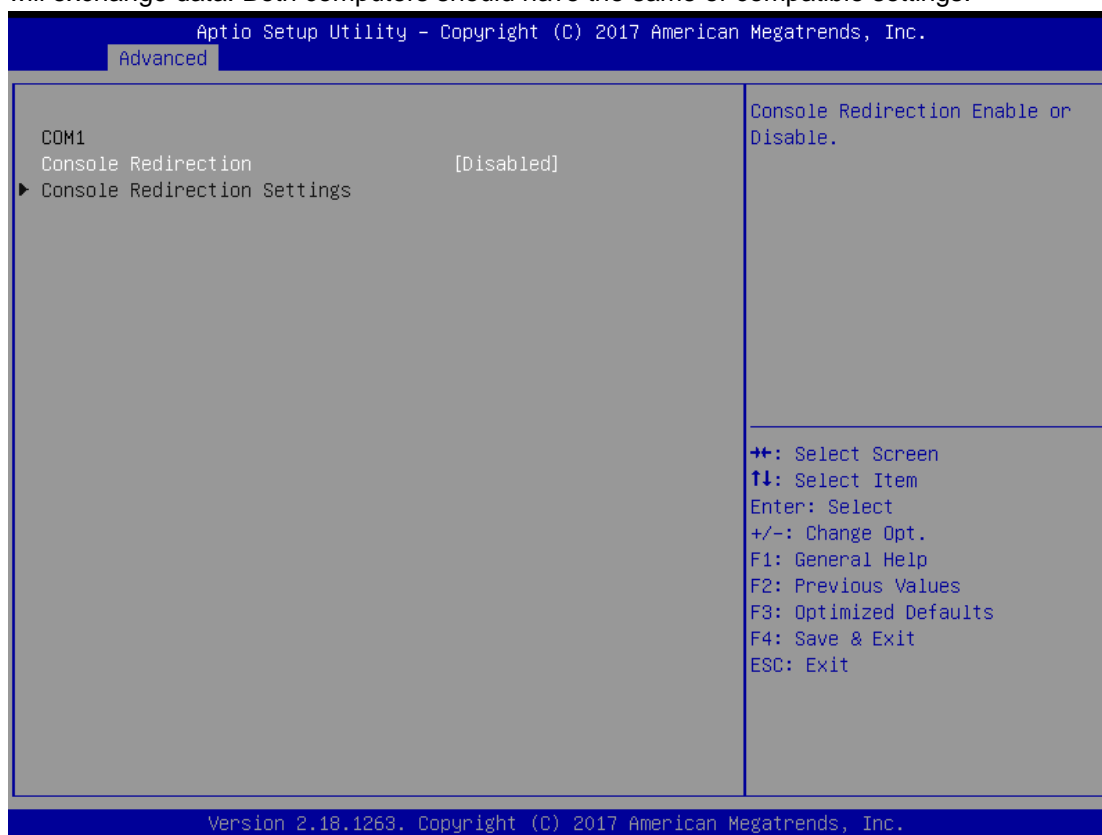

F81803 Super IO Configuration

Set up options for the Super IO Configuration, and change the value of the selected option

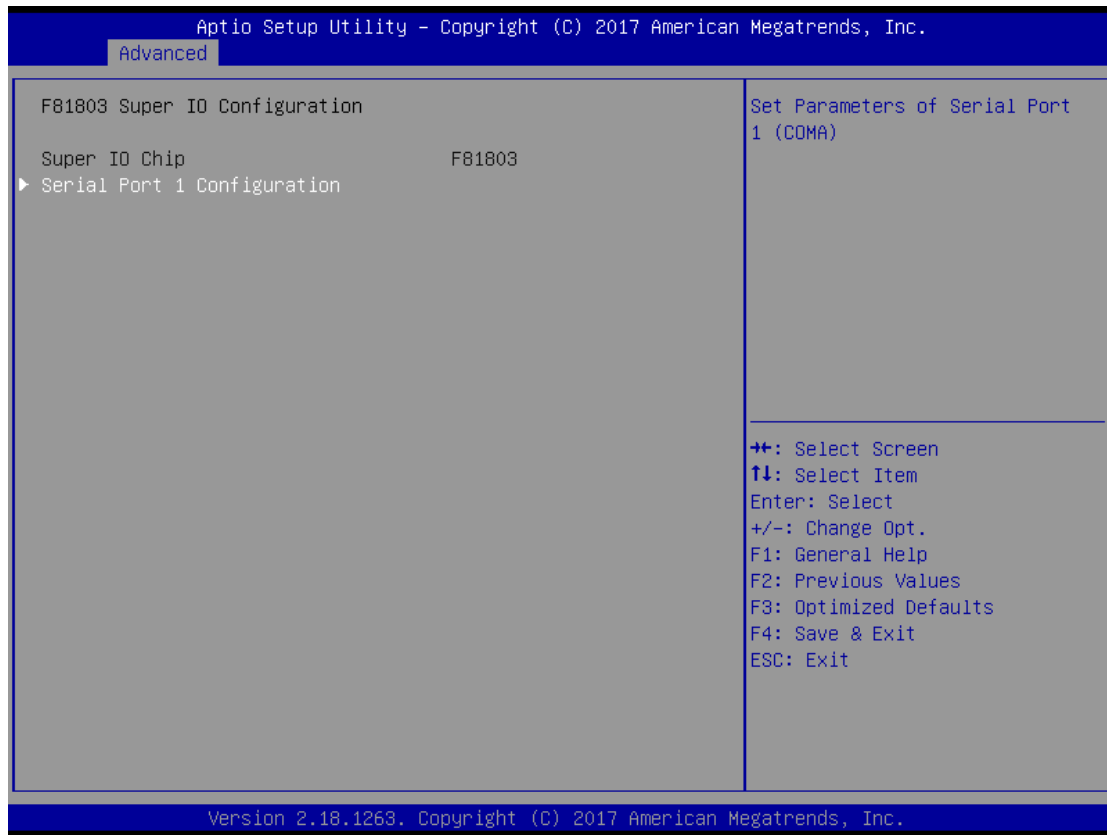

Serial Port 1 configuration

Aptio Setup Utility - Copyright (C) 2017 American Megatrends, Inc.	
Advanced	
Serial Port 1 Configuration	
Serial Port	[Enabled]
Device Settings	IO=3F8h; IRQ=4;
COM Port Type	[RS232]
COM Port Type: RS232, RS422, RS485	
⇐: Select Screen ↑↓: Select Item Enter: Select +/-: Change Opt. F1: General Help F2: Previous Values F3: Optimized Defaults F4: Save & Exit ESC: Exit	
Version 2.18.1263. Copyright (C) 2017 American Megatrends, Inc.	

Serial Port

Enable/Disable serial port

COM Port Type

This option is used to select the RS-232/422/485 function.

Hardware Monitor

This screen shows the Hardware Health Configuration.

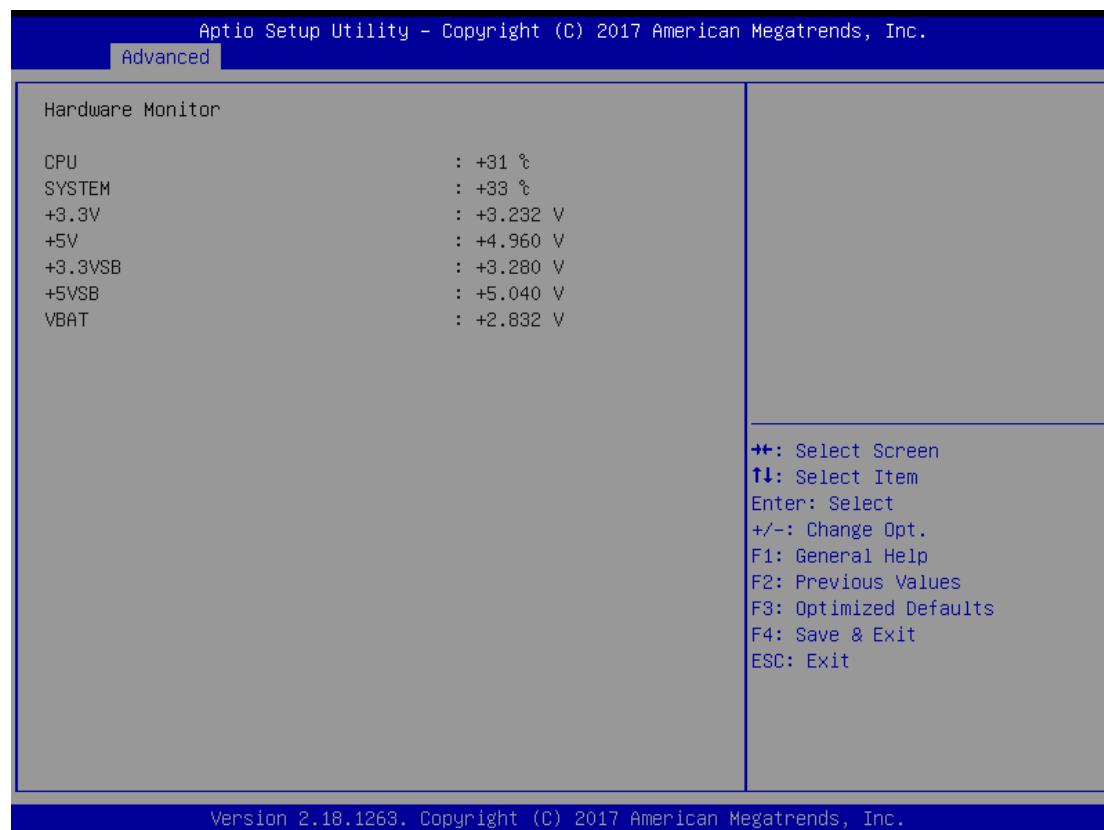

4.5 Chipset Menu

The Chipset menu allows users to change the advanced chipset settings.

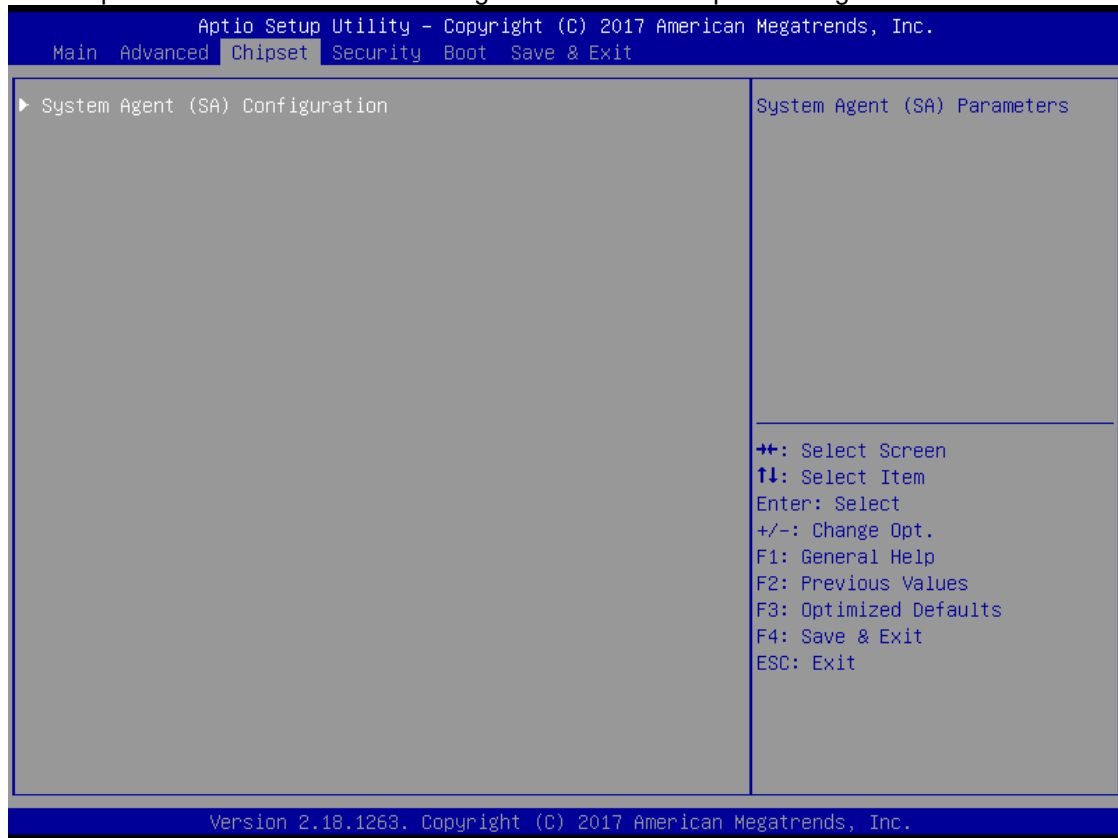

System Agent (SA) Configuration

Memory Configuration

This screen shows the memory information.

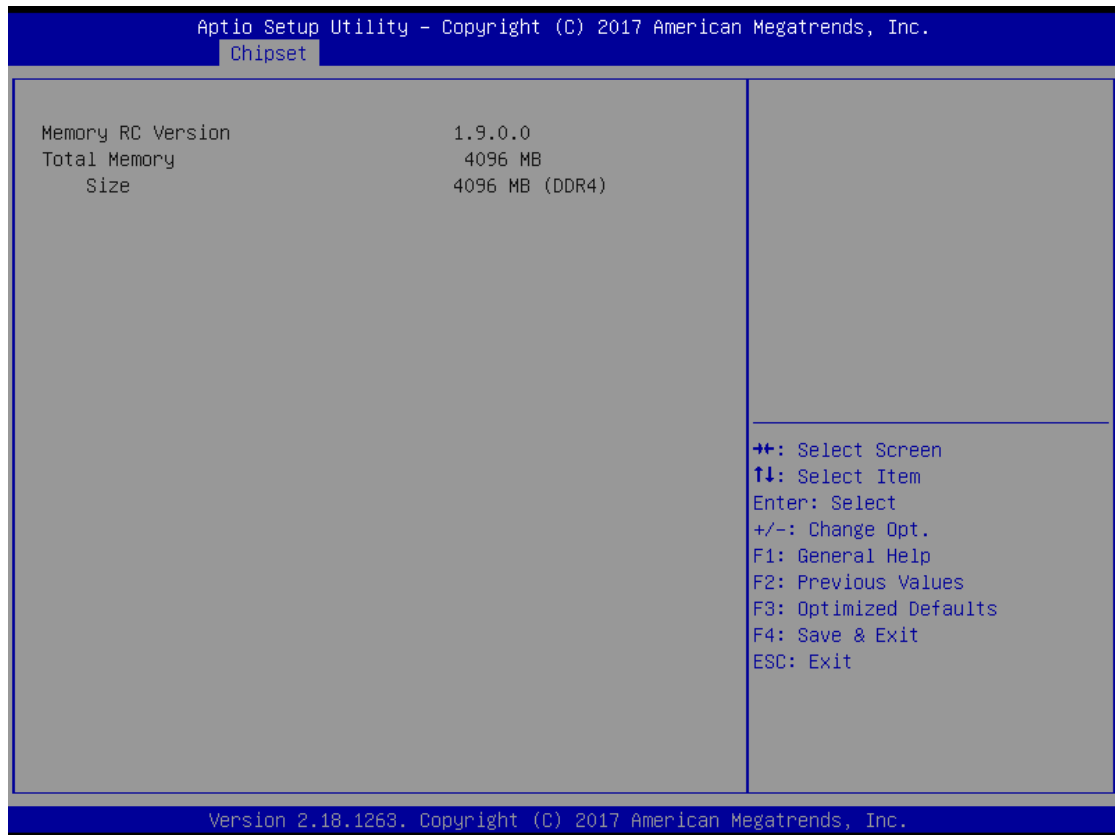

4.7 Boot Menu

The Boot menu allows users to change boot options of the system. You can select any of the items in the left frame of the screen to go to the sub menus:

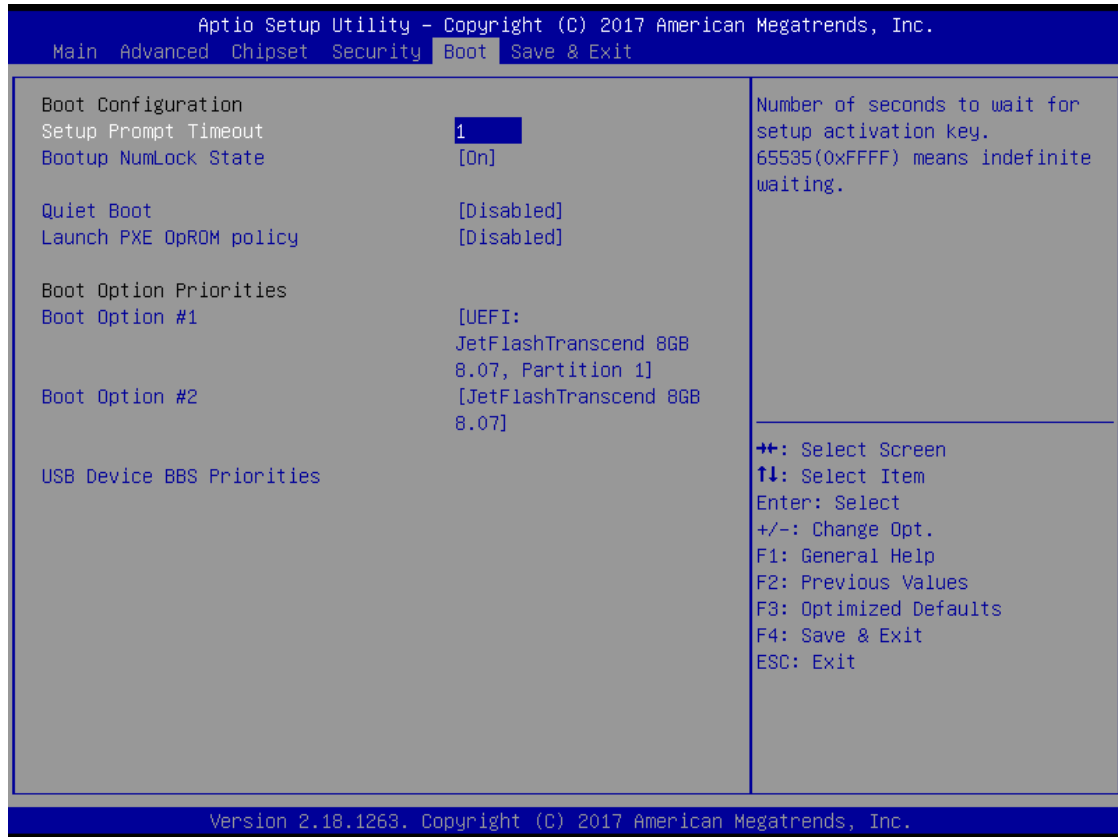

Setup Prompt Timeout

Set the timeout length to wait before entering the Setup menu during system power-on.

Bootup NumLock State

Use this item to select the power-on state for the NumLock. The default setting is on.

Launch PXE OpROM policy

Controls the execution of UEFI and Legacy PXE OpROM

Boot Option Priorities

Use this option to specify the overall boot order from the available devices.

4.8 Save & Exit Menu

This option allows users to operate optimized settings, customized settings and restore default settings for system configuration.

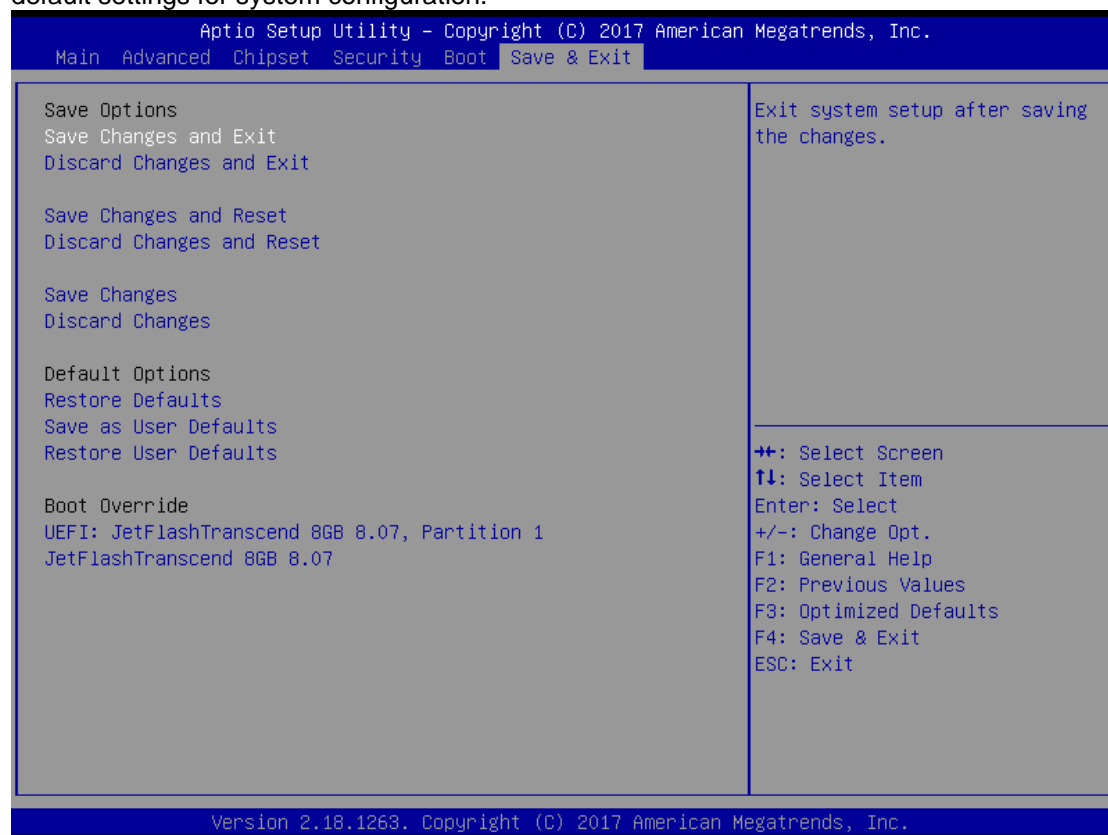

Save Changes and Exit

When you have completed the system configuration changes, select this option to leave Setup and reboot the computer so the new system configuration parameters can take effect. Select *Save Changes and Exit* from the Save & Exit menu and press <Enter>. Select *Ok* to save changes and exit.

Discard Changes and Exit

Select this option to quit Setup without making any permanent changes to the system configuration. Select *Discard Changes and Exit* from the Save & Exit menu and press <Enter>. Select *Ok* to discard changes and exit.

Discard Changes

This option allows you to abandon all the values and changes you set.

Restore Defaults

It automatically sets all Setup options to a complete set of default settings when you select this option. The Optimal settings are designed for maximum system performance, but may not work best for all computer applications. In particular, do not use the Optimal Setup options if your computer is experiencing system configuration problems. Select Load Optimal Defaults from the Save & Exit menu and press <Enter>.

Restore user Defaults

It automatically sets all Setup options to a complete set of default settings when you select this option. The Fail-Safe settings are designed for maximum system stability, but not maximum performance. Select the Fail-Safe Setup options if your computer is experiencing system configuration problems.

Select Load Fail-Safe Defaults from the Save & Exit menu and press <Enter>. Select Ok to load Fail-Safe Defaults.

APPENDIX A WATCHDOG TIMER

What is Watchdog Timer

The integrated Watchdog Timer can be set up by programming. There are 1~255 levels available. After initializing Watchdog Timer by setting a countdown value, the countdown of the value will start automatically when Watchdog Timer is enabled. Watchdog Timer needs to be reset periodically or disabled, otherwise the system will reboot when the value of the timer has reached zero.

How to Use the Watchdog Timer

(The following is an example of enabling configuration using a debug tool.)

Enable WDT

↓

Enable configuration:

O 2E 87 ; Un-lock super I/O

O 2E 87

↓

Select logic device:

O 2E 07

O 2F 07

↓

WDT device enable:

O 2E 30

O 2F 01

↓

Activate WDT:

O 2E F0

O 2F 80

↓

Set base timer:

O 2E F6

O 2F **M** ; **M** = time value

00h~FFh: Time-out disable~ Time-out occurs
after 255 seconds when **N**=71h.

Set Second or Minute :

O 2E F5

O 2F **N** ; **N**=71h or 79h

N=71h, the time base is set to second.

N=79h, the time base is set to minute.

Sample of Watchdog application

Assume that program A must be kept running for a specified period of time:

1. Initialize Watchdog Timer with a countdown time value bigger than the running time of program A.
2. If program A has no problems when its running time has passed, Watchdog will be disabled or reset before its countdown time has reached zero.
3. If program A is running and experiences any problem that can cause the system to shut down, Watchdog Timer will automatically reboot the system when countdown time has reached zero.

Refer to the below flowchart of editing program A

