



AXIOMTEK

MPC102-845

**All-in-One
10.4" XGA TFT Fanless Medical
Touch Panel Computer with Intel®
Celeron® Processor N3060 Onboard**

User's Manual



Disclaimers

This manual has been carefully checked and believed to contain accurate information. Axiomtek Co., Ltd. assumes no responsibility for any infringements of patents or any third party's rights, and any liability arising from such use.

Axiomtek does not warrant or assume any legal liability or responsibility for the accuracy, completeness or usefulness of any information in this document. Axiomtek does not make any commitment to update the information in this manual.

Axiomtek reserves the right to change or revise this document and/or product at any time without notice.

No part of this document may be reproduced, stored in a retrieval system, or transmitted, in any form or by any means, electronic, mechanical, photocopying, recording, or otherwise, without the prior written permission of Axiomtek Co., Ltd.

CAUTION

If you replace wrong batteries, it causes the danger of explosion. It is recommended by the manufacturer that you follow the manufacturer's instructions to only replace the same or equivalent type of battery, and dispose of used ones.

©Copyright 2017 Axiomtek Co., Ltd.

All Rights Reserved

December 2017, Version A2

Printed in Taiwan

Safety Precautions

Before getting started, read the following important cautions.

1. Be sure to ground yourself to prevent static charge when installing the internal components. Use a grounding wrist strap and place all electronic components in any static-shielded devices. Most electronic components are sensitive to static electrical charge.
2. Disconnect the power cords from the MPC102-845 Series before making any installation. Be sure both the system and the external devices are turned OFF. Sudden surge of power could ruin sensitive components. Make sure the MPC102-845 Series is properly grounded.
3. Do not open the system's top cover. If opening the cover for maintenance is a must, only a trained technician is allowed to do so. Integrated circuits on computer boards are sensitive to static electricity. To avoid damaging chips from electrostatic discharge, observe the following precautions:
 - Before handling a board or integrated circuit, touch an unpainted portion of the system unit chassis for a few seconds. This will help to discharge any static electricity on your body.
 - When handling boards and components, wear a wrist-grounding strap, available from most electronic component stores.

Trademarks Acknowledgments

Axiomtek is a trademark of Axiomtek Co., Ltd.

Windows[®] is a trademark of Microsoft Corporation.

IBM, PC/AT, PS/2, VGA are trademarks of International Business Machines Corporation.

Intel[®] and Pentium[®] are trademarks of Intel Corporation.

AMI is trademark of American Megatrend Inc.

Other brand names and trademarks are the properties and registered brands of their respective owners.

Table of Contents

Disclaimers.....	ii
Safety Precautions.....	iii
Chapter 1 Introduction.....	1
1.1 General Description	1
1.2 Specifications.....	2
1.3 Dimensions.....	4
1.4 I/O Outlets	6
1.5 Packing List	7
Chapter 2 Hardware and Installation	9
2.1 SBC87845 Jumpers and Connectors.....	10
2.1.1 Jumper Settings	12
2.1.2 Connectors	13
2.2 Ethernet.....	20
2.3 Mountings – Wall/Desktop/VESA	21
2.3.1 Wall-Mounting	21
2.3.2 Desktop-Mounting	21
2.3.3 VESA-ARM Mounting.....	23
2.4 HDD Installation.....	24
2.5 DRAM Installation.....	26
2.6 Mini cards Card Installation.....	28
2.6.1 Wireless LAN Card Installation	28
2.6.2 mSATA Card Installation.....	30
2.7 Power Input (Phoenix type)	31
Chapter 3 AMI BIOS Setup Utility	33
3.1 Navigation Keys	33
3.2 Main Menu.....	34
3.3 Advanced Menu.....	35
3.4 Chipset Menu.....	42
3.5 Security	44
3.6 Boot Menu.....	45
3.7 Save & Exit.....	46

Chapter 4	Drivers Installation	47
4.1	System	47
4.1.1	Win 7	47
4.1.2	Win 8/8.x	48
4.2	Touch Screen.....	48
4.2.1	Specification	48
4.2.2	Driver Installation- Windows 7/8.x.....	49
4.3	Embedded O.S.....	51
4.3.1	WES 7 & WE8S.....	51

This page is intentionally left blank.

Chapter 1

Introduction

This chapter contains general information and detailed specifications of the MPC102-845. Chapter 1 includes the following sections:

- General Description
- Specifications
- Dimensions
- I/O Outlets
- Package List

1.1 General Description

The MPC102-845 is a fan-less and compact-size medical touch panel computer, equipped with a 10.4" TFT LCD display and low power consumption Intel® Celeron® N3060 processor(2M Cache, up to 2.48 GHz). The MPC102-845 supports Windows 7, Windows 8.x , Windows 10 and Windows embedded OS. The panel computer is able to install a mSATA card and provide two Mini card slot for wireless module. Its excellent ID and friendly user interface make it a professional yet easy-to-use panel computer. The MPC102-845 is an ideal for space-limited in medical application.

MPC102-845: 10.4" TFT XGA Fanless Medical Touch Panel Computer

- **Reliable and Stable Design**
The MPC102-845 adopts a fanless cooling system and a mSATA, which makes it suitable for vibration environments.
- **Embedded O.S. Supported**
The MPC102-845 not only supports Windows 7, Windows 8.x , Windows 10 and Windows embedded OS. For storage device, the MPC102-845 supports mSATA and 2.5" SATA device.
- **Medical-grade Product Design**
The MPC102-845 has an incredible design to be used in different medical environments.

The front bezel meets the IP65 and whole enclosure meets IPX1 standard.

For connecting other devices, the MPC102-845 also features several interfaces: USB, Ethernet, and RS-232/422/485.

1.2 Specifications

Main CPU Board

- **CPU**
 - Intel® Celeron® Processor N3060 (2M Cache, up to 2.48 GHz) onboard.

- **System Memory**
 - One 204-pin DDR3L SO-DIMM socket
 - Maximum memory up to 8GB

- **BIOS**
 - America Megatrends BIOS

I/O System

- **Standard I/O**
 - One RS-232/422/485
 - One RS-232
 - Two USB 2.0
 - Two USB 3.0

- **Ethernet**
 - 2 x 10/100/1000Mbps

- **Audio**
 - One Line out
 - Built-in two 2W speaker

- **Expansion**
 - Two PCIe Mini card

- **Storage**
 - One mSATA
 - One 2.5" SATA HDD

- **Power connector**
 - MPC102-845-DC: 9VDC to 36VDC with phoenix power connector
 - MPC102-845-J: External 65W Medical AC Adapter with screw type connector

System Specification

- **10.4" XGA(1024x768) LCD with LED backlight**
- **5 wired Resistive Touch**
- **Fanless Heat Dispensing Design**
- **Disk drive housing:**
 - One 2.5" SATA drive
- **Net Weight**
 - 1.8 Kgs (3.96 lb)
- **Dimension (Main Body Size)**
 - 292.5 c 45.8 x 235.8 mm
- **Operation Temperature**
 - 0°C to 40°C
- **Relative Humidity**
 - 10% to 90% @ 40°C, Non-Condensing
- **Vibration**
 - 2.0G, 5 to 500 Hz, 2.0 G random for CF card
- **Power input**
 - 9~36 VDC with phoenix power connector*
 - External 65W Medical AC Adapter
 - Power Input: 90VAC to 264VAC
 - Power Output: 12VDC, Max. 5.42A



NOTE *All specifications and images are subject to change without notice.*



NOTE *The DC power source to be used with MPC102-845 must be galvanically isolated according to IEC60601-1 safety of medical devices!*

1.3 Dimensions

This diagram shows you dimensions and outlines of the MPC102-845.

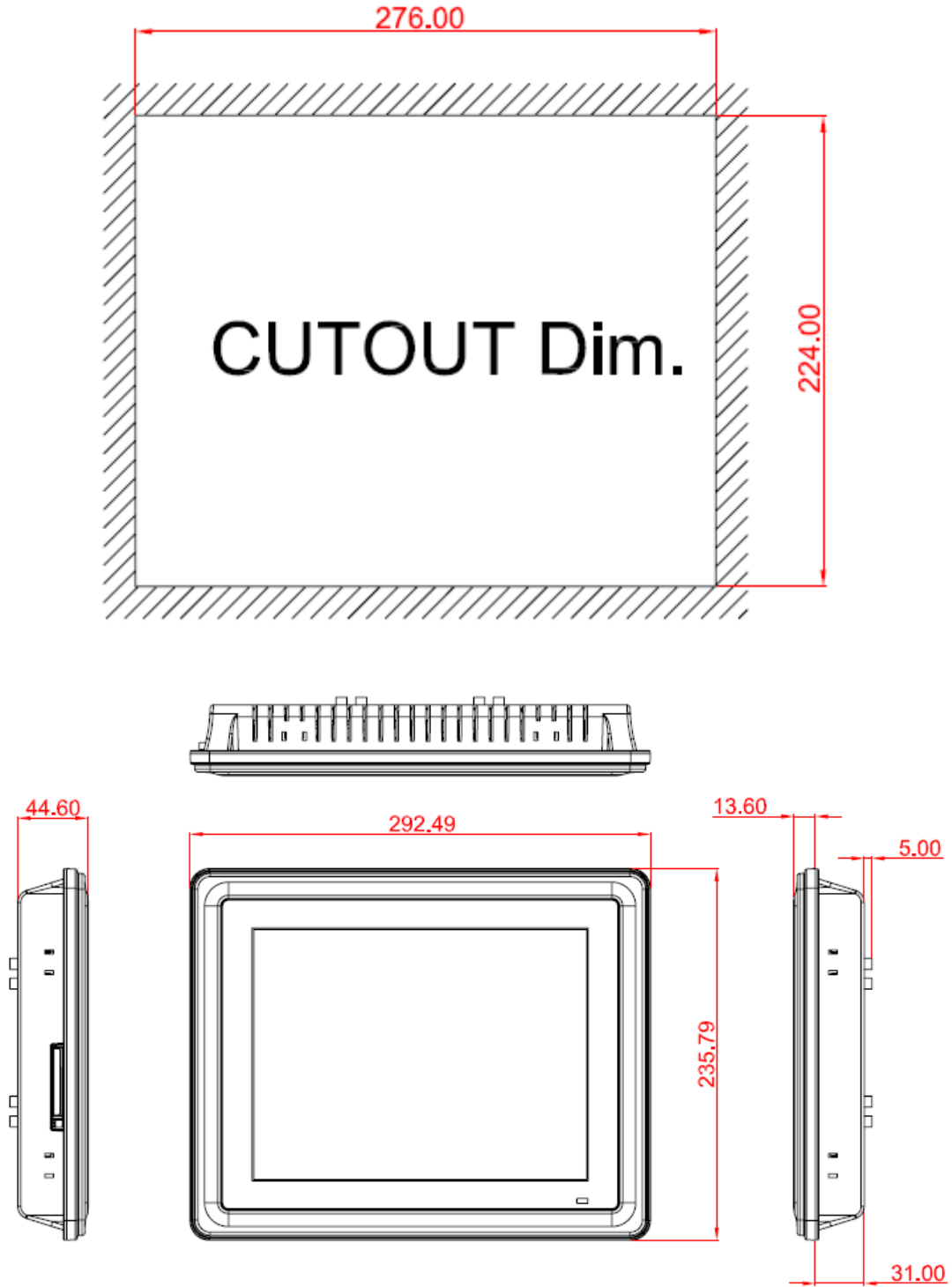

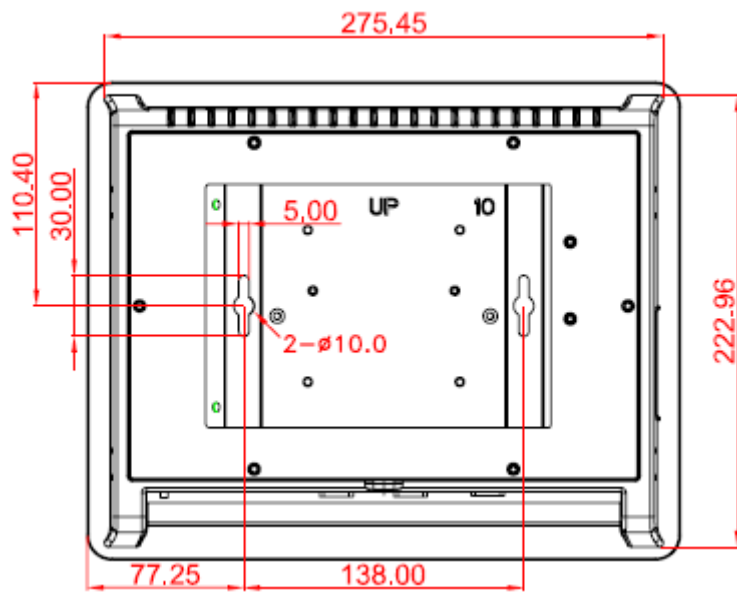
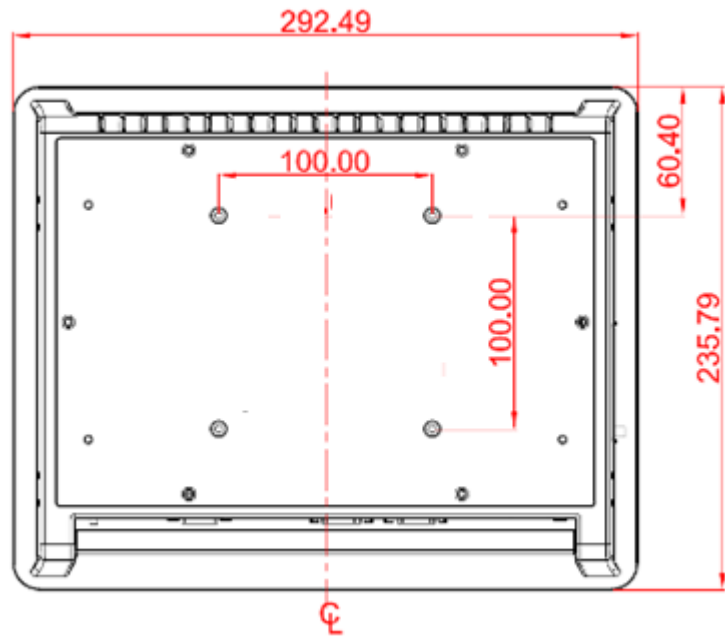

1.4 I/O Outlets

Please refer to the following illustration for I/O locations of the MPC102-845.

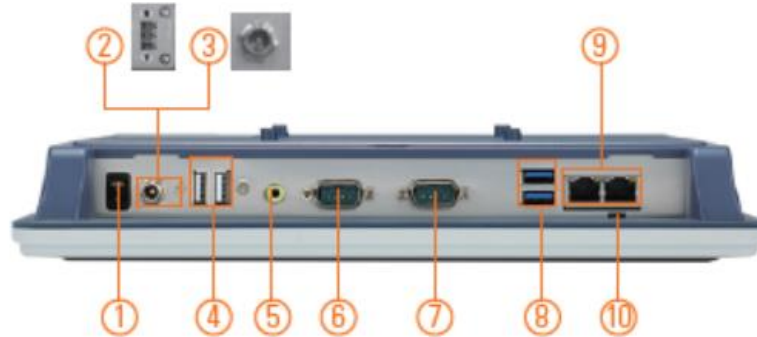

No	Function	No	Function
1	POWER SWITCH (ATX)	7	COM 2(RS-232)
2	Power Input connector (Phoenix)	8	Dual USB 3.0 ports
3	Power Input connector (Screw)	9	Ethernet (RJ-45)
4	Dual USB 2.0 ports	10	AT/ATX selectable switch
5	AUDIO (LINE-OUT)		
6	COM 1(RS-232/422/485)		



No	Function	No	Function
11	Touch LED indicator	13	Power LED indicator
12	Touch on/off button		

1.5 Packing List

When you receive the MPC102-845, the bundled package should contain the following items:

- **MPC102-845 x 1**
- **Driver CD x1**
- **Screws for HDD x4**
- **Wall mount bracket (optional)**
- **Phoenix connector x 1 (for MPC102-845-DC)**
- **Power Adapter & power cord (for MPC102-845-J)**

If you can not find the package or any items are missing, please contact Axiomtek distributors immediately.

This page is intentionally left blank.

Chapter 2

Hardware and Installation

The MPC102-845 provides rich I/O ports and flexible expansions for you to meet different demands, The chapter will show you how to install the hardware. It includes:

- SBC87845 Jumpers and Connectors
- Ethernet
- Mounting Way
- Hard disk
- DRAM
- Wireless LAN Card
- Power Input

2.1 SBC87845 Jumpers and Connectors

Component Side

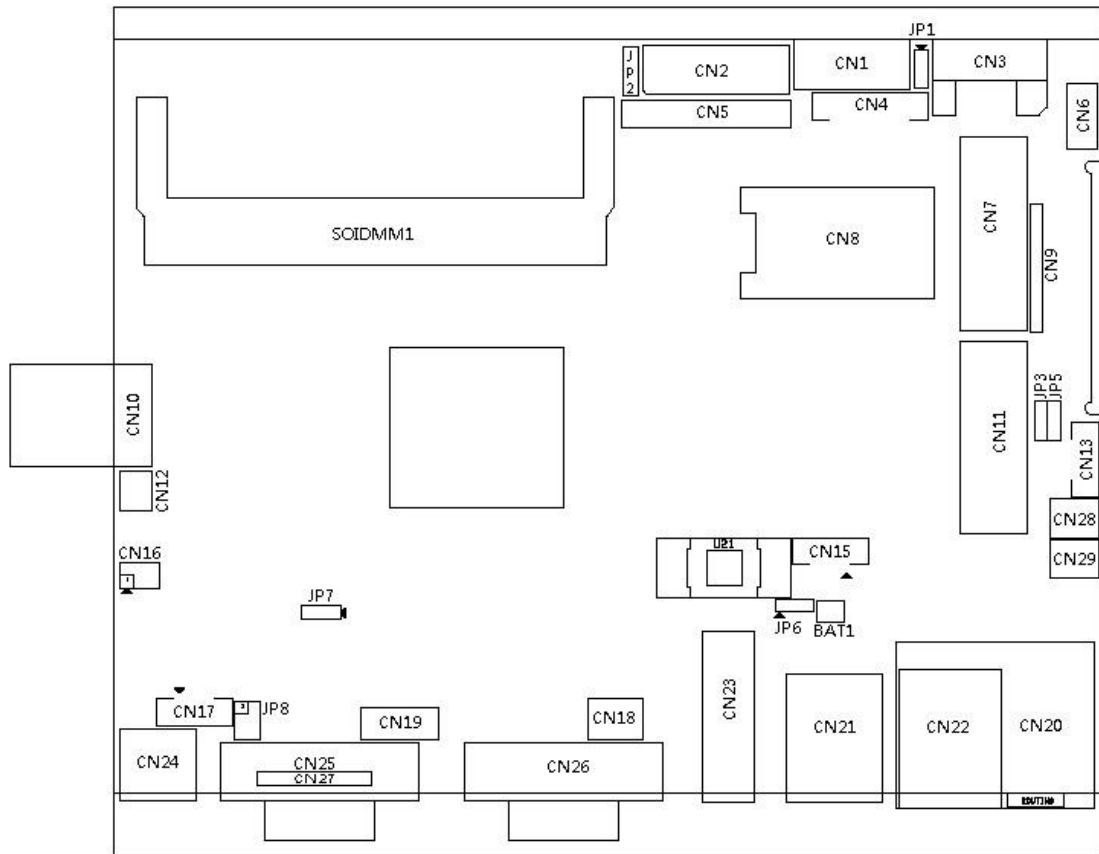

Solder Side

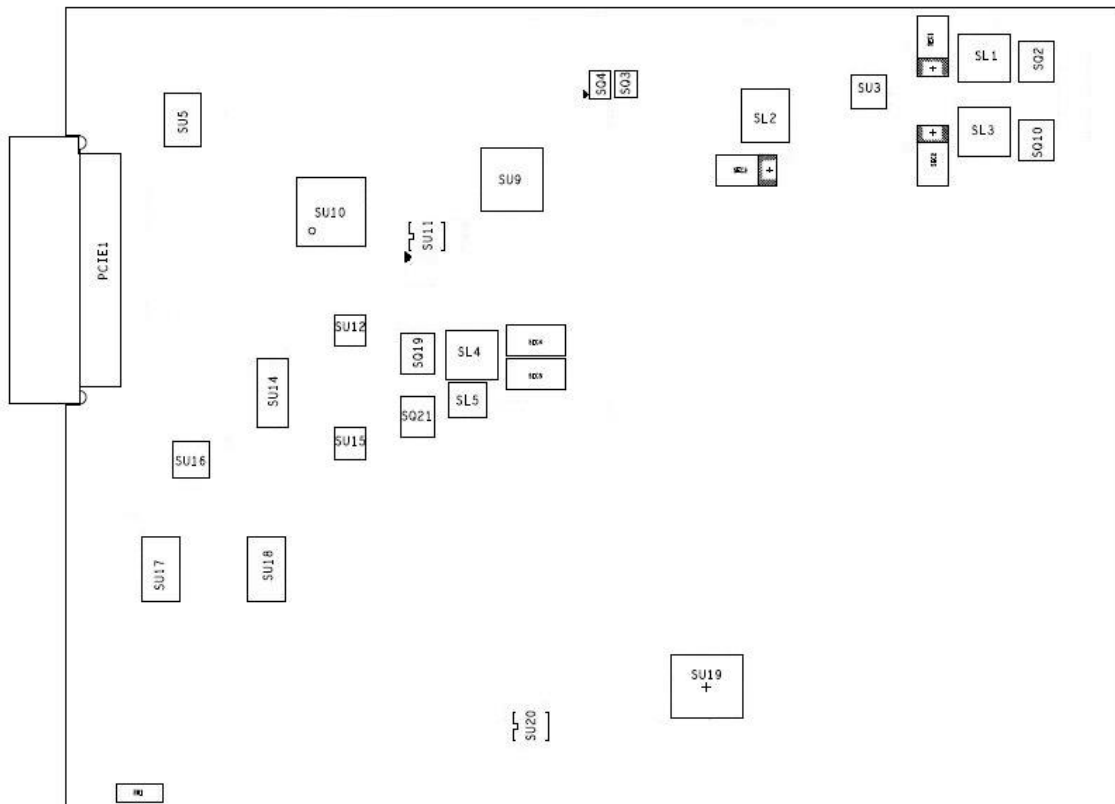

2.1.1 Jumper Settings

Making the proper jumper settings configure the **SBC87845** to match the needs of your application.

The following table shows the default jumper settings for the onboard devices.

Jumper	★ Default Setting	Jumper Setting
JP1	★ OSD function: LCD ON/OFF OSD function: Touch ON/OFF	Short 1-2 Short 2-3
JP2	★ LVDS Panel Power : 3.3V LVDS Panel Power : 5V	Short 1-2 Short 2-3
JP3	★ ATX mode AT mode	Short 1-2 Short 2-3
JP5	Touch Controller 4,8 WIRE ★ Touch Controller 5 WIRE	Short 1-2 Short 2-3
JP6	★ Normal Clear CMOS	Short 1-2 Short 2-3
JP7	★ Internal Buzzer enable Internal Buzzer disable	Short 1-2 Short 2-3
JP8	★ COM1 normal mode COM1 pin1 with power :+5V COM1 pin9 with power :+12V	Short 3-5,4-6 Short 1-3,4-6 Short 3-5,2-4

2.1.2 Connectors

The connectors allow the CPU Board to connect with other parts of the system. Ensure that all connectors are in place and firmly attached. The following table lists the function of each connector on the **SBC87845**

Connectors	Label
LVDS inverter connector	CN1
LVDS connector	CN2
SATA connector	CN3
OSD connector	CN4
HDD power connector	CN6
Full size min-PCIe connector	CN7,CN11
SIM card connector	CN8
DIO connector	CN9
Power connector	CN10
Power Button connector	CN12
Touch connector	CN13
LIN/MIC In connector	CN16
Speaker Out connector	CN17
System Fan connector	CN18
USB2.0 connector	CN19
RJ45 connector	CN20,CN22
USB3.0 connector	CN21
HDMI connector	CN23
Audio out connector	CN24
RS232/422/485 Port connector	CN25,CN27
RS232 Port connector	CN26
+5V Standby Power connector	CN28,CN29

LVDS inverter connector: CN1

Pin	Description	Pin	Description
1	GND	5	Inverter ON-OFF
2	GND	6	+12V
3	GND	7	+12V
4	Backlight control	8	+12V

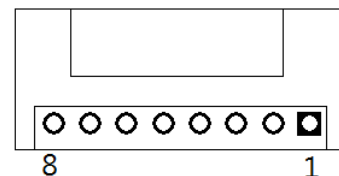

LVDS connector: CN2**Pin Assignment**

Pin	Description	Pin	Description
1	VCC	21	GND
2	VCC	22	GND
3	VCC	23	LVDSA_DATAN0
4	VCC	24	LVDSB_DATAN2
5	VCC	25	LVDSA_DATAP0
6	VCC	26	LVDSB_DATAP2
7	Resolution selection[0]	27	GND
8	Resolution selection[1]	28	GND
9	GND	29	LVDSA_DATAN1
10	GND	30	LVDSA_DATAN3
11	LVDSB_DATAN3	31	LVDSA_DATAP1
12	LVDSB_DATAN0	32	LVDSA_DATAP3
13	LVDSB_DATAP3	33	GND
14	LVDSB_DATAP0	34	GND
15	GND	35	LVDSA_DATAN2
16	GND	36	LVDSA_CLKN
17	LVDSB_CLKN	37	LVDSA_DATAP2
18	LVDSB_DATAN1	38	LVDSA_CLKP
19	LVDSB_CLKP	39	Resolution selection[2]
20	LVDSB_DATAP1	40	Resolution selection[3]

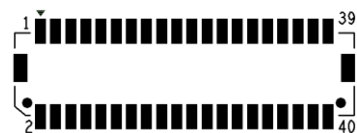

HDD power connector: CN6

Pin	Description
1	+12V
2	GND
3	GND
4	+5V

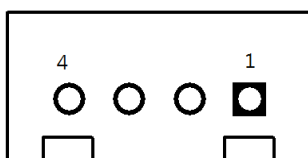
**Full-size PCI-Express Mini Card: CN7**

This is a full-size PCI-Express Mini Card connector on the top side complying with PCI-Express Mini Card Spec. V1.2. It supports either PCI-Express or USB 2.0.

Pin	Signal	Pin	Signal
1	PCIE_WAKE3_N	2	+3.3V_SBY
3	No use	4	GND
5	No use	6	+1.5V
7	GND	8	SIM_PWR
9	GND	10	SIM_DATA
11	PCIE_REFCLK3_DN	12	SIM_CLK
13	PCIE_REFCLK3_DP	14	SIM_REST
15	GND	16	SIM_VPP
17	No use	18	GND
19	No use	20	+3.3V_SBY
21	GND	22	PLTRST_1_N
23	PCIE_P3_RXN	24	+3.3V_SBY
25	PCIE_P3_RXP	26	GND
27	GND	28	+1.5V
29	GND	30	SMB_CLK_SBY
31	PCIE_P3_TXN	32	SMB_DATA_SBY
33	PCIE_P3_TXP	34	GND
35	GND	36	USB_DN1
37	GND	38	USB_DP1
39	+3.3V_SBY	40	GND
41	+3.3V_SBY	42	No use
43	GND	44	No use
45	No use	46	No use
47	No use	48	+1.5V
49	No use	50	GND
51	No use	52	+3.3V_SBY

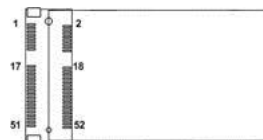

SIM card connector: CN8

Pin	Description	Pin	Description
1	UIM PWR	5	GND
2	UIM RST	6	UIM VPP
3	UIM CLK	7	UIM DATA
4	NC	8	NC

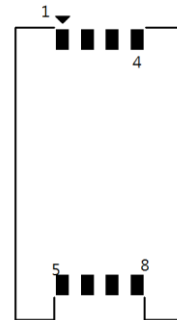

DIO connector: CN9

Pin	Description
1	GPIO0
2	GPIO1
3	GPIO2
4	GPIO3
5	GPIO4
6	GND
7	GPIO5
8	GPIO6
9	+3.3V
10	GPIO7



Power connector: CN10

Pin	Description
1	DCIN (+12V)
2	DCIN (+12V)
3	GND
4	GND

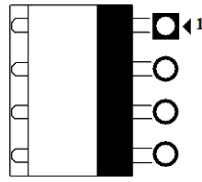
**Full-size PCI-Express Mini Card and mSATA Connector: CN11**

This is a full-size PCI-Express Mini Card connector on the top side complying with PCI-Express Mini Card Spec. V1.2. It supports either PCI-Express, USB 2.0 or SATA (mSATA).

Pin	Signal	Pin	Signal
1	PCIE_WAKE2_N	2	+3.3V_SBY
3	No use	4	GND
5	No use	6	+V1.5S
7	GND	8	No use
9	GND	10	No use
11	PCIE_REFCLK2_DN	12	No use
13	PCIE_REFCLK2_DP	14	No use
15	GND	16	No use
17	No use	18	GND
19	No use	20	+3.3V_SBY
21	GND	22	PLTRST_1_N
23	PCIE_mSATA_Card_RXN	24	+3.3V_SBY
25	PCIE_mSATA_Card_RXP	26	GND
27	GND	28	+V1.5S
29	GND	30	SMB_CLK_3P3_SBY
31	PCIE_mSATA_Card_TXN	32	SMB_DATA_3P3_SBY
33	PCIE_mSATA_Card_TXP	34	GND
35	GND	36	USB_DN2
37	GND	38	USB_DP2
39	+3.3V_SBY	40	GND
41	+3.3V_SBY	42	No use
43	GND	44	No use
45	No use	46	No use
47	No use	48	+V1.5S
49	No use	50	GND
51	No use	52	+3.3V_SBY

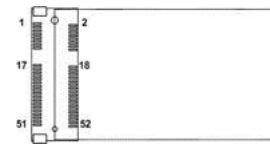
**Power button connector: CN12**

Pin	Description	Pin	Description
1	GND	2	PWBTN

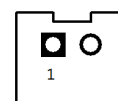

TOUCH connector: CN13

Pin	Description
1	Sense
2	X+
3	X-
4	Y+
5	Y-

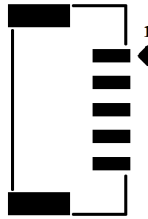

Lin/Mic In connector: CN16

Pin	Description	Pin	Description
1	LIN IN R	2	GND
3	LIN IN L	4	GND
5	MIC IN	6	GND

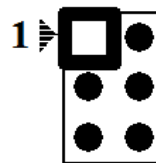

Speaker connector: CN17

Pin	Description
1	SPKOUT_L-
2	SPKOUT_L+
3	SPKOUT_R-
4	SPKOUT_R+
5	GND



System Fan connector: CN18

Pin	Description
1	GND
2	+12V / Speed control output
3	Fan speed detect

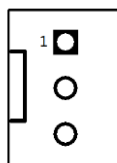

USB2.0 connector: CN19

Pin	Description	Pin	Description
1	+5V	2	+5V
3	USB-	4	USB-
5	USB+	6	USB+
7	GND	8	GND
9	GND	10	GND

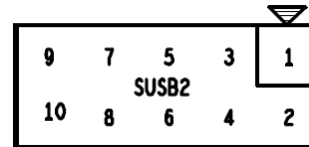
**+5V Standby Power connector: CN28, CN29**

Pin	Description	Pin	Description
1	GND	2	+5V_SBY

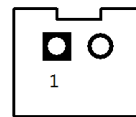
**COM port Connector**

The pin assignment of RS-232/RS-422/RS-485 is listed on the following table.

Pin	RS-232	RS-422	RS-485
1	DCD	TX-	Data-
2	RXD	TX+	Data+
3	TXD	RX+	No use
4	DTR	RX-	No use
5	GND	GND	GND
6	DSR	No use	No use
7	RTS	No use	No use
8	CTS	No use	No use
9	RI	No use	No use

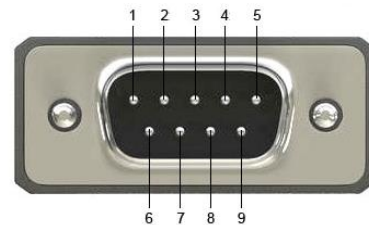

2.2 Ethernet

The **GOT5100T-845** is equipped with two high performance Plug and Play Ethernet interfaces, full compliant with IEEE 802.3 standard, and can be connected with a RJ-45 LAN connector.

Please refer to detailed pin assignment list below:

Pin	Signal
1	TX+ (Data transmission positive)
2	TX- (Data transmission negative)
3	Rx+(Data reception positive)
4	RJ45 termination
5	RJ45 termination
6	Rx- (Data reception negative)
7	RJ45 termination
8	RJ45 termination

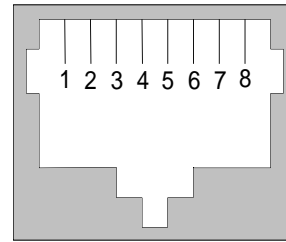

RJ45

2.3 Mountings – Wall/Desktop/VESA

There are several mounting ways for the MPC102-845, Panel, Wall, Desktop and VESA mountings.

2.3.1 Wall-Mounting

The MPC102-845 is designed for Wall mounting application. Please refer to the following steps:

Fix wall mount bracket on the back of the unit.



2.3.2 Desktop-Mounting

The MPC102-845 is designed for desktop mounting application. Please refer to the following steps:

Step 1 Find out the screws as marked on the back side of chassis.



Step 2 Assemble the desktop stand to the chassis, and fix the screws.



CAUTION : Use recommended/suitable mounting apparatus to avoid risk of injury.

2.3.3 VESA-ARM Mounting

Step 1 Find out the screws as marked on the back side of chassis.



Step 2 Assemble the VESA-ARM to the back side of the chassis, and fix the screws.



Step 3 VESA mounting Installation completed.

CAUTION : Use recommended/suitable mounting apparatus to avoid risk of injury.

2.4 HDD Installation

The MPC102-845 provides a convenient Hard Disk Drive (HDD) bracket for users to install 2.5" SATA HDD. Please follow the steps:

Step 1 Unscrew eight screws to open the back cover.

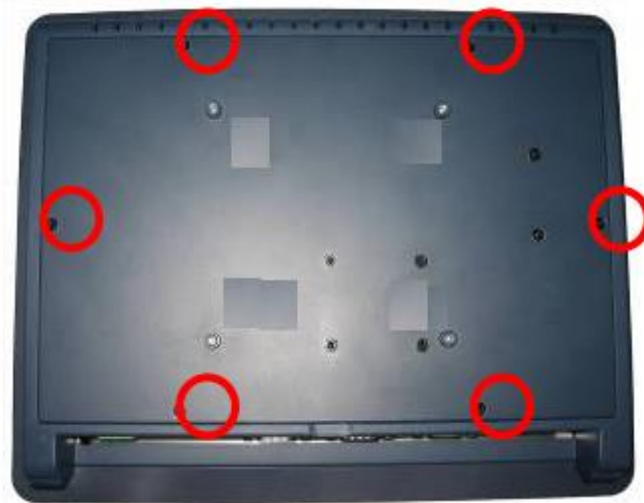

Step 2 Find out the HDD slot in back cover.

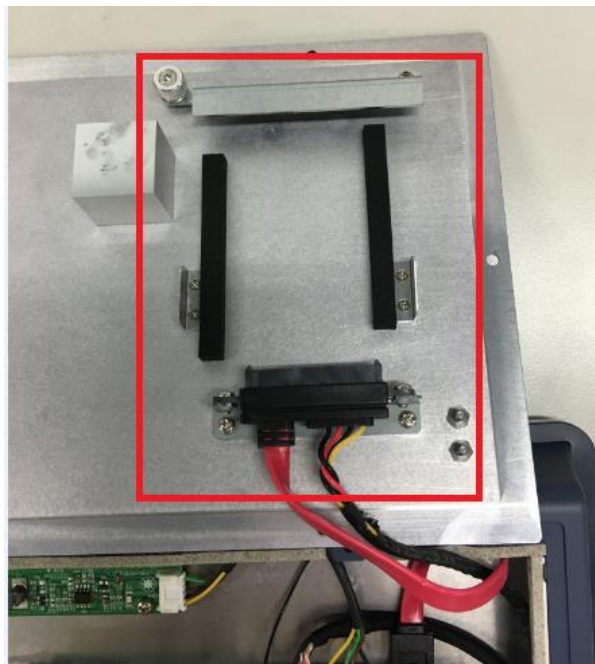

Step 3 Unscrew the thumbscrew.

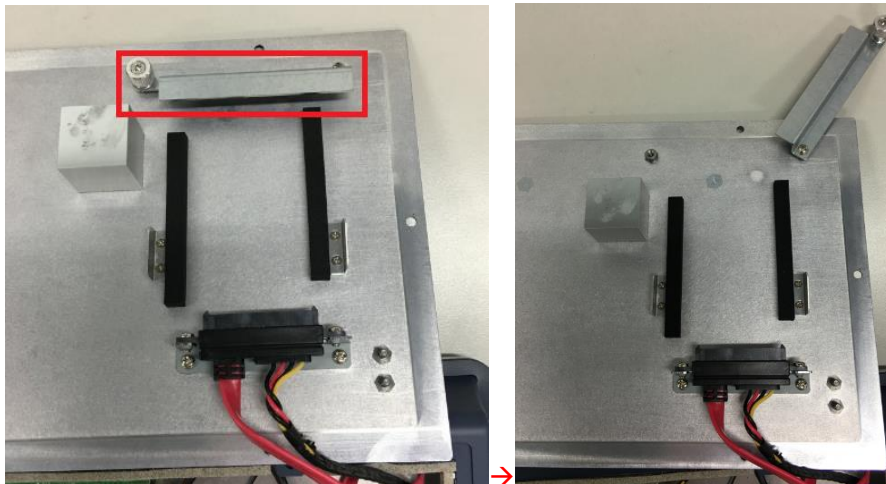

CAUTION : When the HDD thickness is less than 9.5mm, please add HDD sponges.

Step 4 Insert the 2.5" SATA HDD to the connector.



Step 5 Screw the thumbscrew. Installation completed.



2.5 DRAM Installation

The MPC102-845 provides one 204-pin DDR3L SODIMM socket that support system memory up to 8GB. Please follow steps below to install the memory modules:

Step 1 Open the back cover and find out the DIMM socket on main board(SBC87845).



- Step 2** Insert the DRAM to the DIMM socket, and then push it down firmly until it is clipped by the socket.

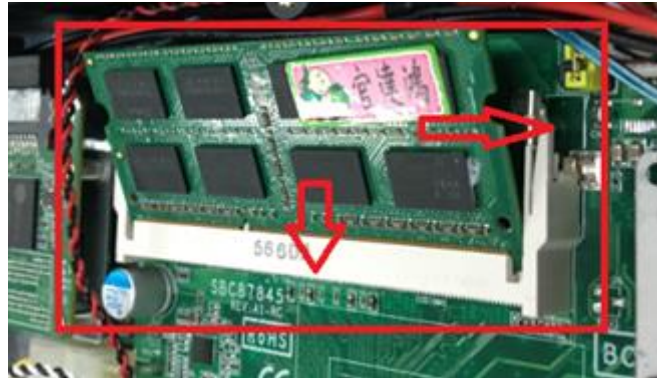

- Step 3** Install the memory module into the socket and push it firmly down until it is fully seated. The socket latches are levered upwards and clipped on to the edges of the DIMM.



2.6 Mini cards Card Installation

2.6.1 Wireless LAN Card Installation

The MPC102-845 provides two Mini card slots for user to install wireless LAN cards. You can choose either slot 1 or slot 2 to install the wireless LAN card and refer to the following instructions and illustration:

Step 1 Open the back cover and find out the mini-card slot on main board.



Step 2 Insert the wireless LAN card to the slot. Screw it firmly on the slot.

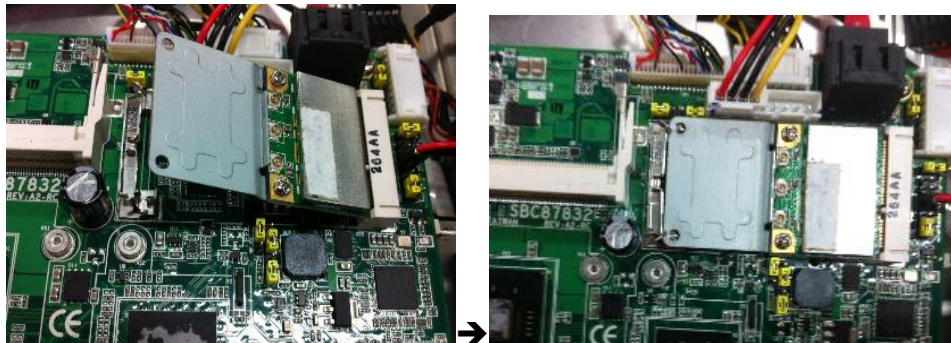

- Step 3 Find the built-in Antenna cable.**
There are two connectors on wireless LAN card. One is MAIN, and the other is secondary. Connect antenna cable to MAIN connector on wireless LAN card.



2.6.2 mSATA Card Installation

The MPC102-845 provides one Mini card slot for user to install mSATA. Please choose the slot 2 when installing the mSATA card and refer to the following instructions and illustration:

Step 1 Open the back cover and find out the mini-card slot on main board.

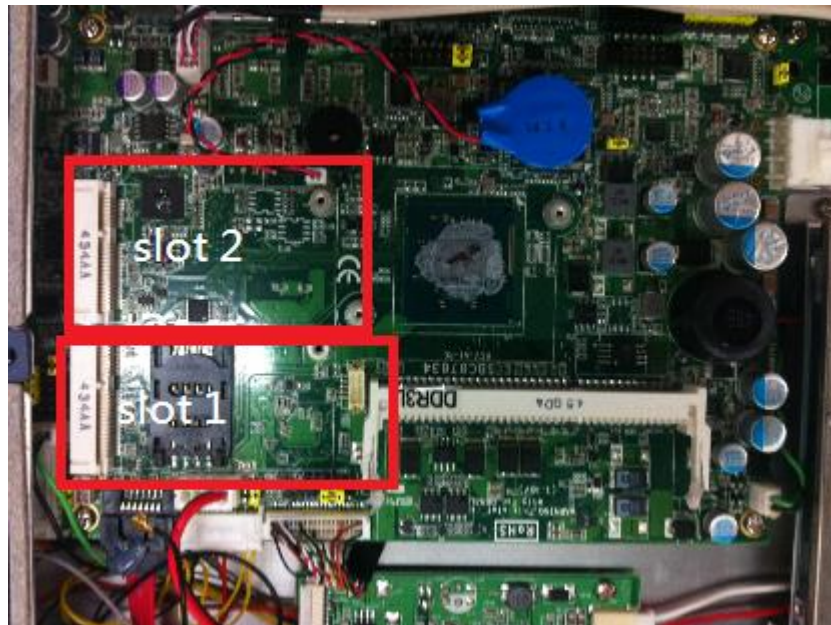

Step 2 Insert the mSATA card to the slot 2. Screw it firmly on the slot.



NOTE The screws of mini card slots are M12 type.

2.7 Power Input (Phoenix type)

MPC102-845 equips with a phoenix type power connector. It adopts 9~36VDC. Please follow the signs on power connector to connect DC power source.

+ : Power positive - : Power negative



NOTE: The safety ground must be connected to ensure the unit working appropriately.



NOTE: The DC power source to be used with MPC102-845 must be galvanically isolated according to IEC60601-1 safety of medical devices!

This page is intentionally left blank.

Chapter 3

AMI BIOS Setup Utility

This chapter provides users with detailed description how to set up basic system configuration through the AMIBIOS8 BIOS setup utility.

3.1 Navigation Keys

The BIOS setup/utility uses a key-based navigation system called hot keys. Most of the BIOS setup utility hot keys can be used at any time during the setup navigation process. These keys include <F1>, <F2>, <F3>, <F4>, <Enter>, <ESC>, <Arrow> keys, and so on.



NOTE Some of navigation keys differ from one screen to another.

← Left/Right	The Left and Right <Arrow> keys allow you to select a setup screen.
↑↓ Up/Down	The Up and Down <Arrow> keys allow you to select a setup screen or sub-screen.
+– Plus/Minus	The Plus and Minus <Arrow> keys allow you to change the field value of a particular setup item.
Tab	The <Tab> key allows you to select setup fields.
F1	The <F1> key allows you to display the General Help screen.
F2	The <F2> key allows you to load previous value
F3	The <F3> key allows you to Load Optimized Defaults.
F4	The <F4> key allows you to save any changes you have made and exit Setup. Press the <F4> key to save your changes.
Esc	The <Esc> key allows you to discard any changes you have made and exit the Setup. Press the <Esc> key to exit the setup without saving your changes.
Enter	The <Enter> key allows you to display or change the setup option listed for a particular setup item. The <Enter> key can also allow you to display the setup sub-screens.

3.2 Main Menu

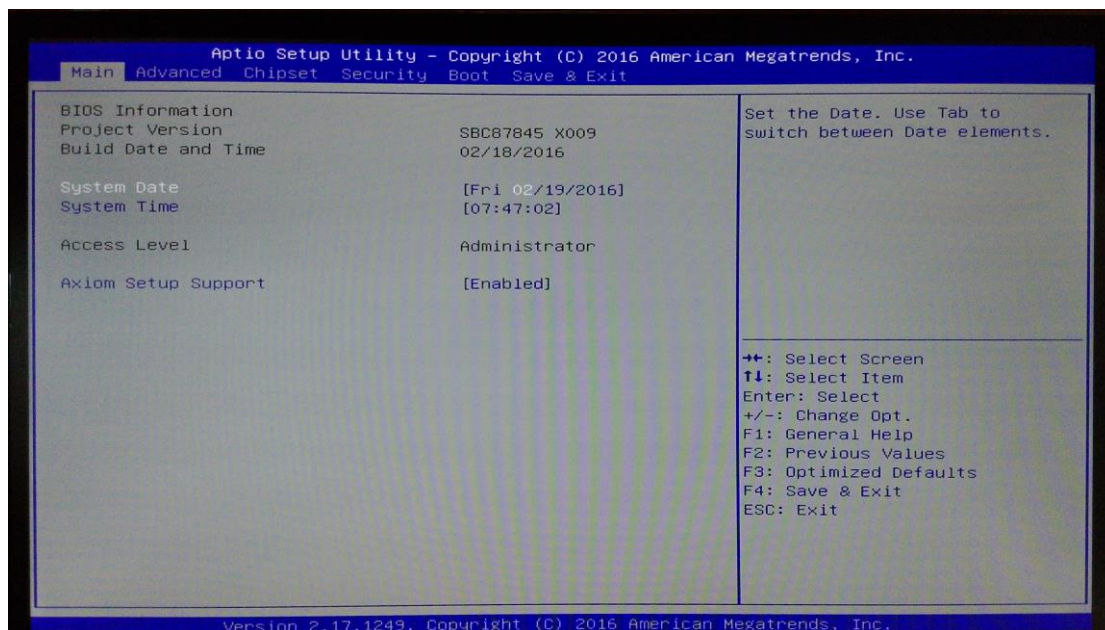

System Time/Date

Use this option to change the system time and date. Highlight *System Time* or *System Date* using the <Arrow> keys. Enter new values through the keyboard. Press the <Tab> key or the <Arrow> keys to move between fields. The date must be entered in MM/DD/YY format. The time is entered in HH:MM:SS format.

3.3 Advanced Menu

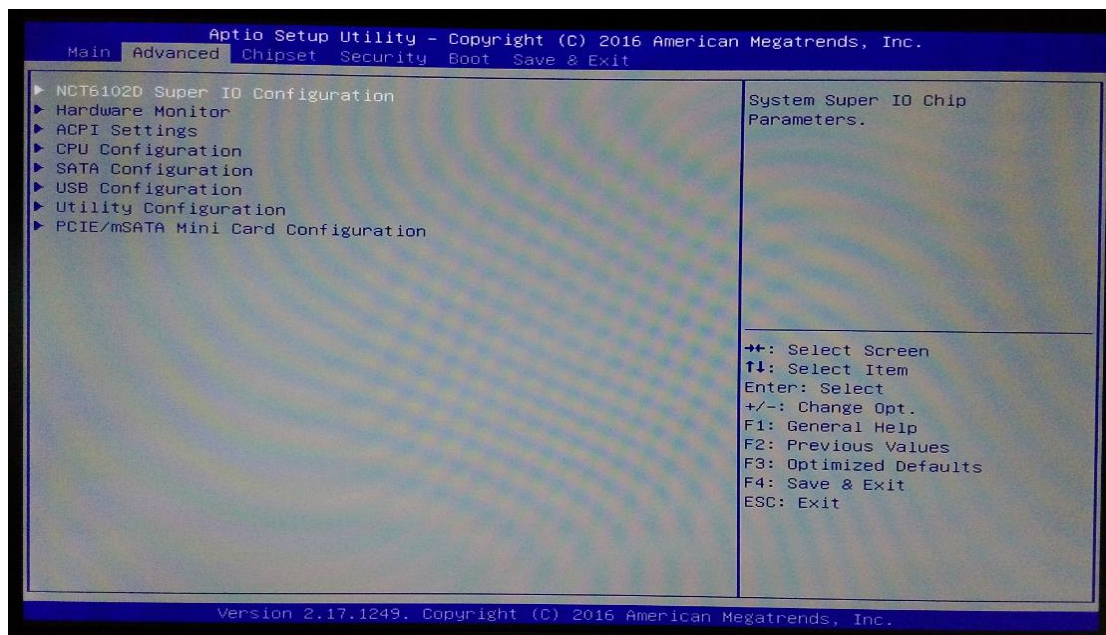

The Advanced menu allows users to set configuration of the CPU and other system devices. You can select any of the items in the left frame of the screen to go to the sub menus:

- NCT6106D Super IO Configuration
- Hardware Monitor
- ACPI Settings
- CPU Configuration
- SATA Configuration
- USB Configuration
- Utility Configuration
- PCIE/mSATA Mini Card Configuration

For items marked with "▶", please press <Enter> for more options.

NCT6106D Super IO Configuration

Use this screen to select options for the Super IO Configuration, and change the value of the selected option

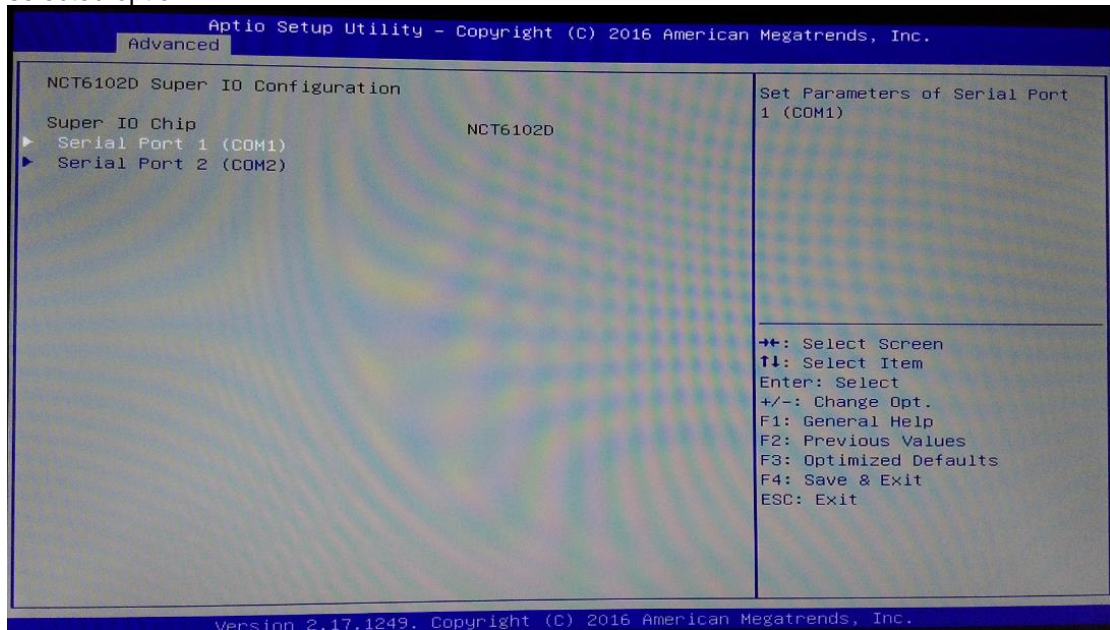

- **Serial Port 1-2 configuration**

Serial port

This option used to enable or disable the serial port.

Device Setting

This item specifies the base I/O port address and Interrupt Request address of serial port.

The port 1 Optimal setting is *3F8/IRQ4*.

The port 2 Optimal setting is *2E8/IRQ3*.

Serial type

This option used to select RS232/422/485 function.

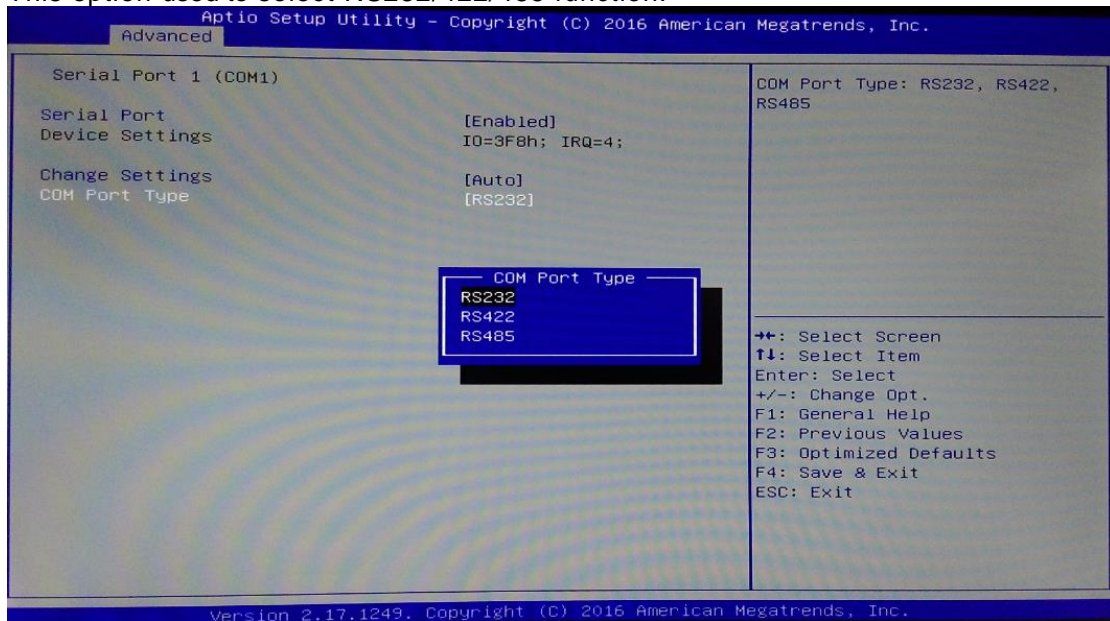

Hardware Monitor

This screen shows the Hardware Health Status in real time.

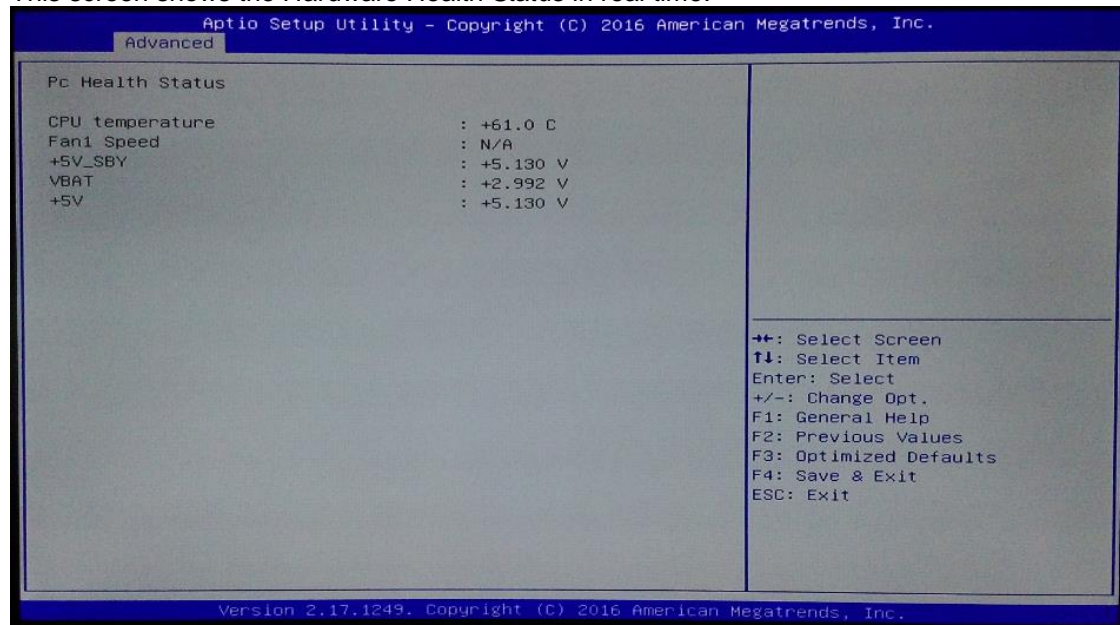

ACPI Settings

You can use this screen to select options for the ACPI Configuration, and change the value of the selected option. A description of the selected item appears on the right side of the screen.

ACPI Sleep State

Allow you to select the Advanced Configuration and Power Interface (ACPI) state to be used for system suspend. Here are the options for your selection, Suspend disable and S3 (Suspend to RAM).

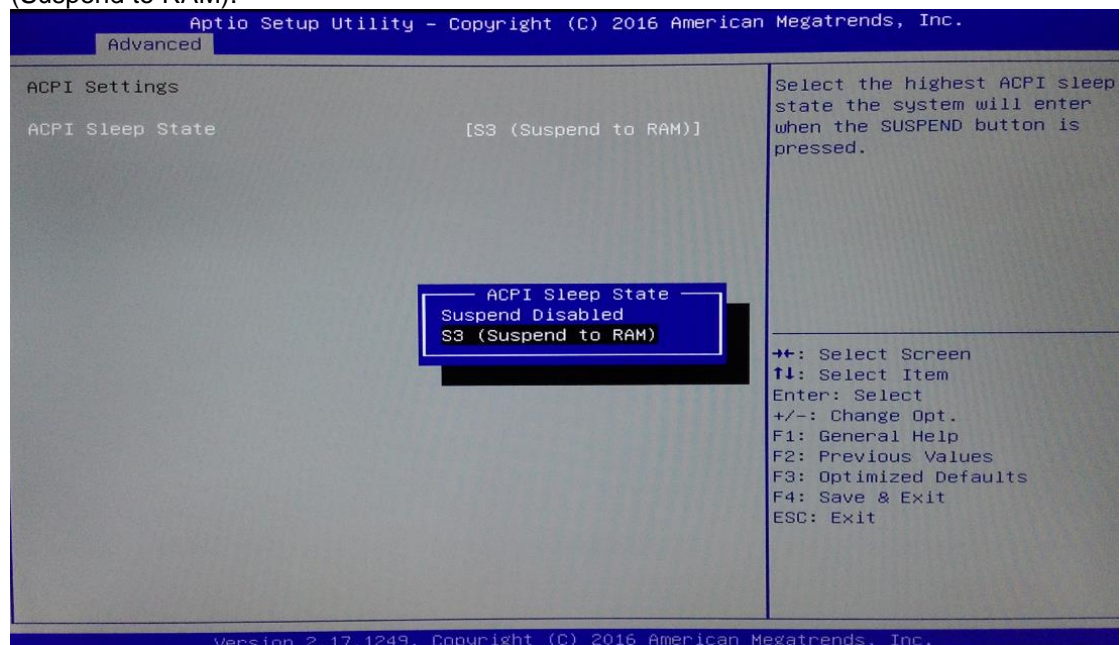

CPU Configuration

This screen shows the CPU Configuration and intel virtualization technology enable/disable selected.

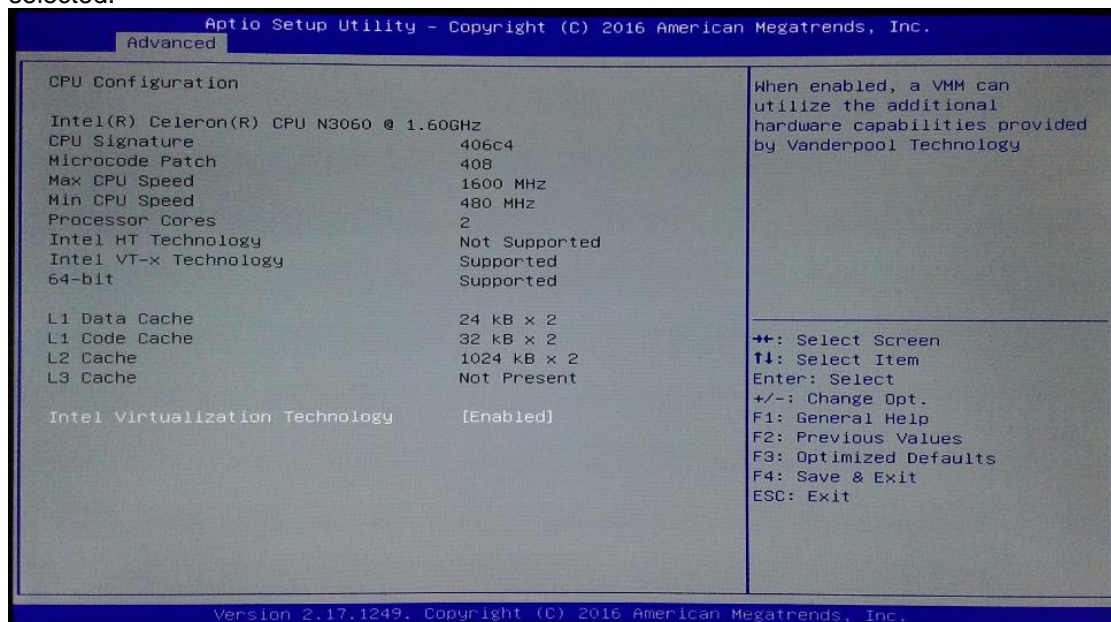

SATA Configuration

You can use this screen to select options for the SATA Configuration, and change the value of the selected option.

- SATA Controller

Use this item to choose the SATA Controller. Here are the options for your selection, Enable, Disable.

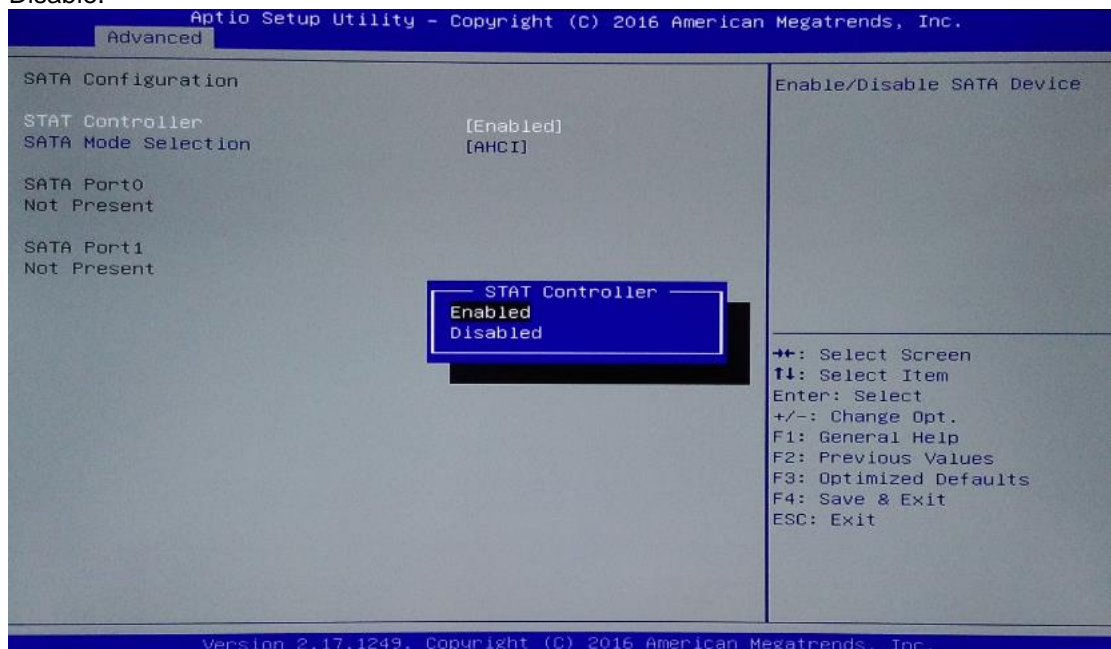

USB Configuration

This screen shows the USB Configuration.

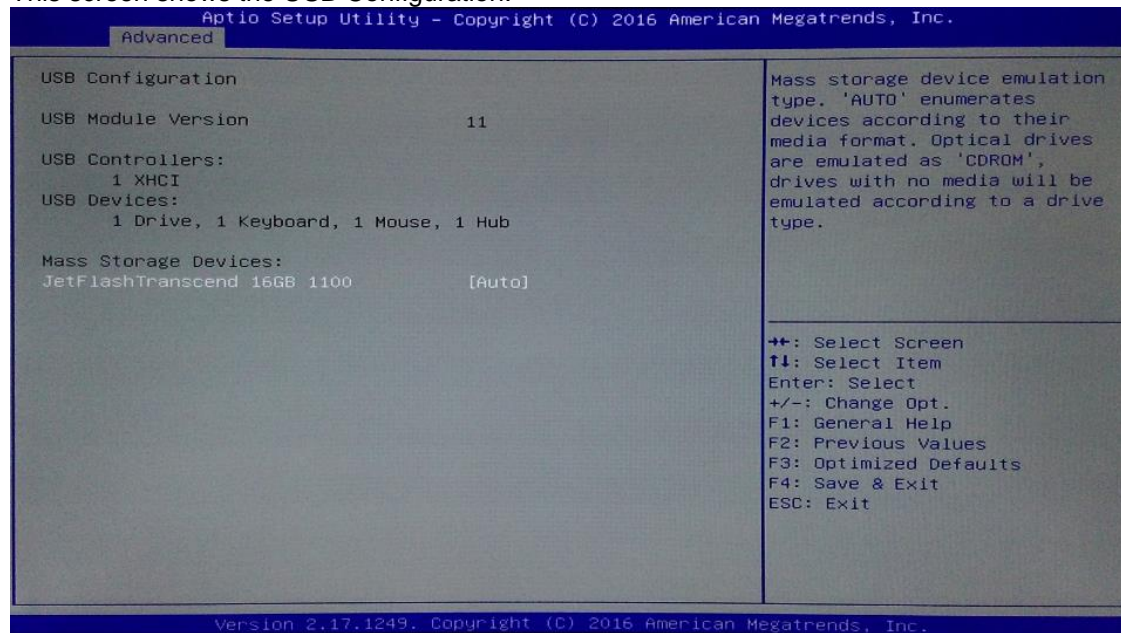

Utility Configuration

This screen shows the Utility Configuration.

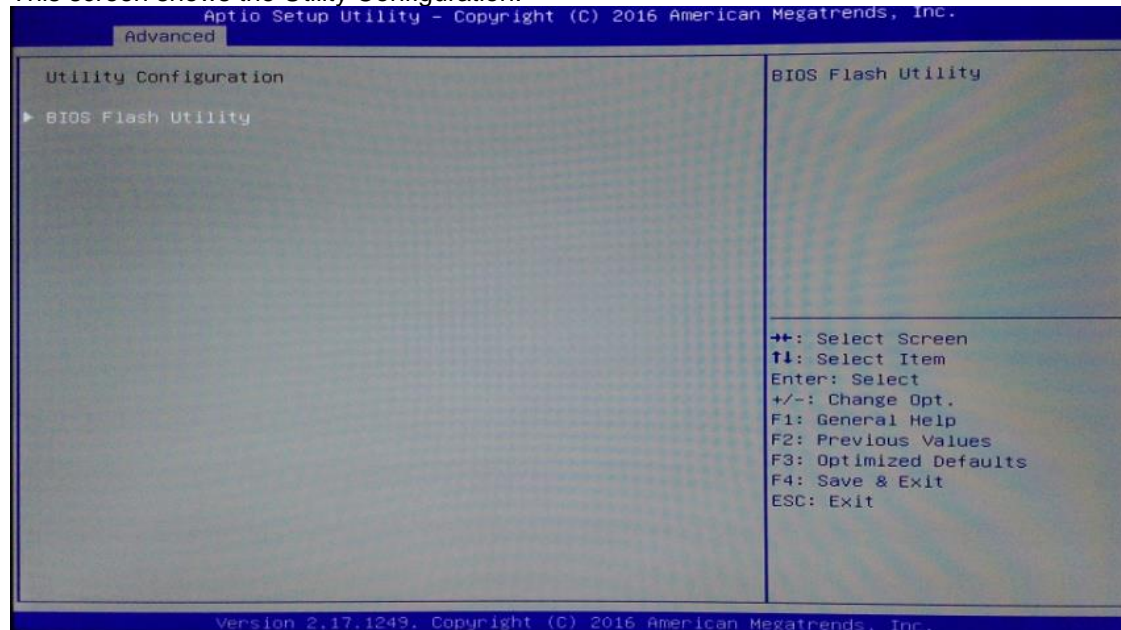

PCIe/mSATA Mini Card Configuration

This screen shows the PCIe/mSATA Mini Card Configuration. Here are the options for your selection, PCIe, mSATA.

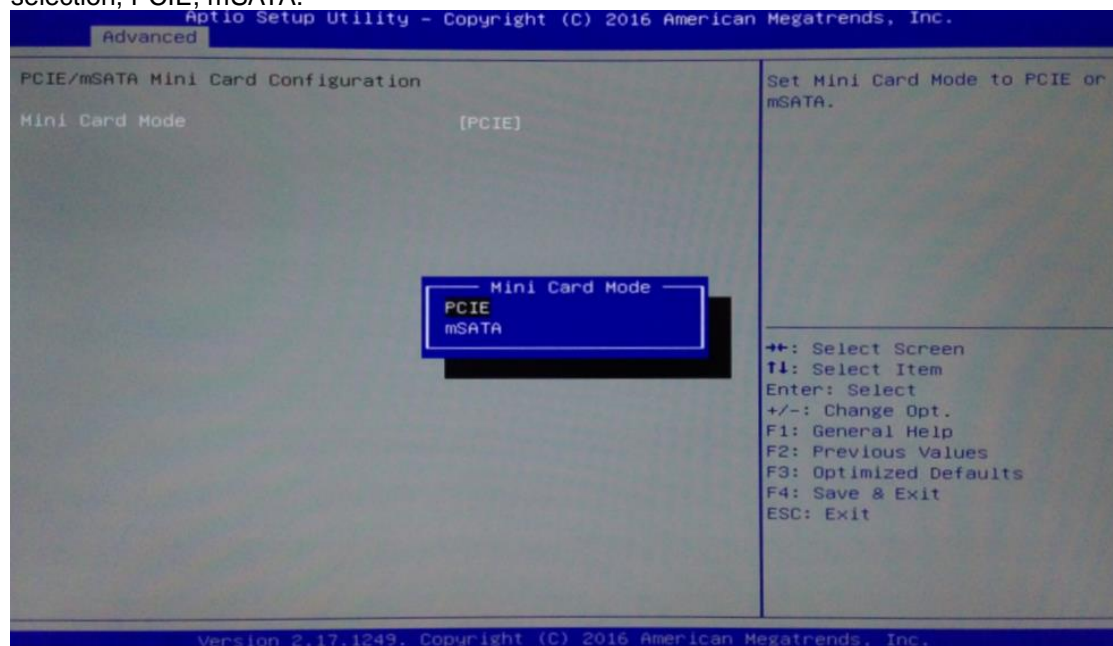

3.4 Chipset Menu

The Chipset menu gives the North Bridge memory information and South Bridge TXE information.

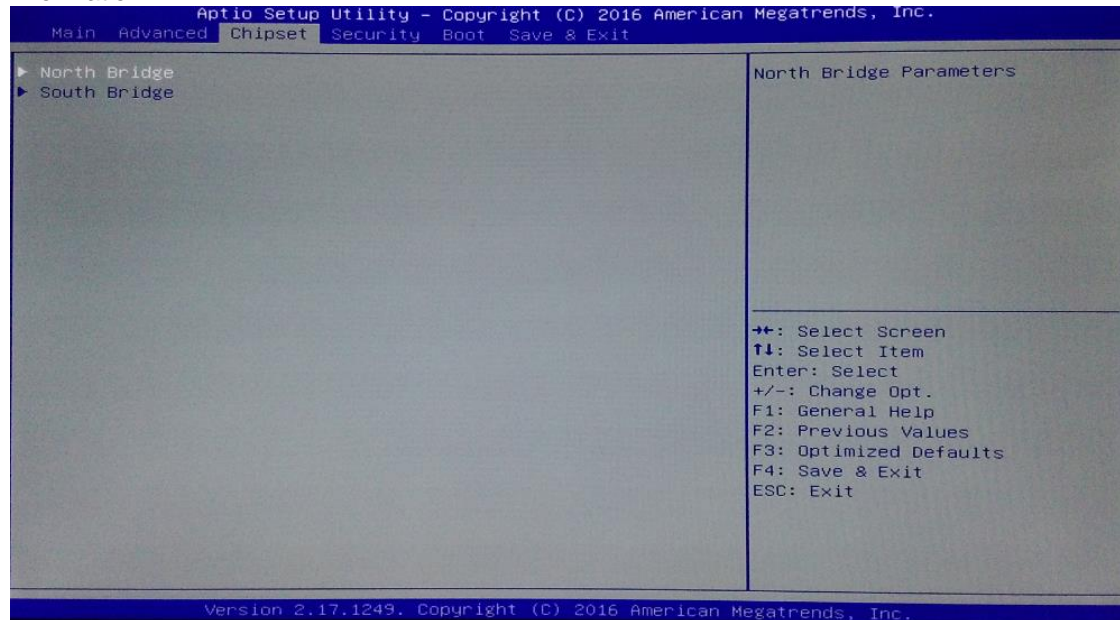

North Bridge

This screen shows the North Bridge memory information.

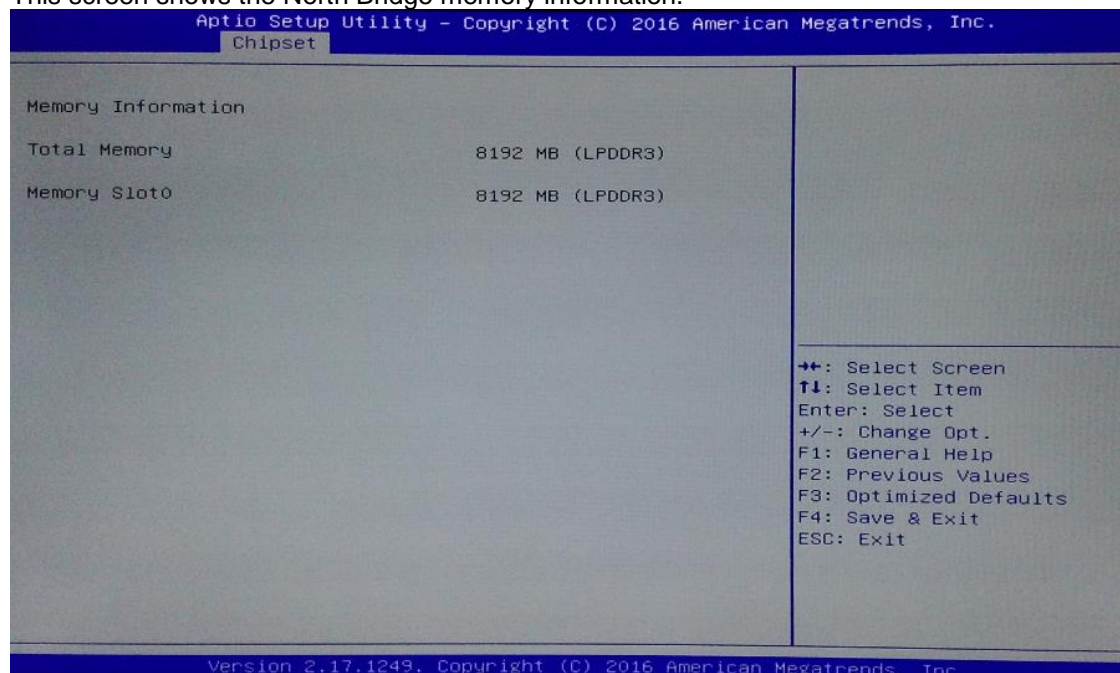

South Bridge

This screen shows the South Bridge TXE information.

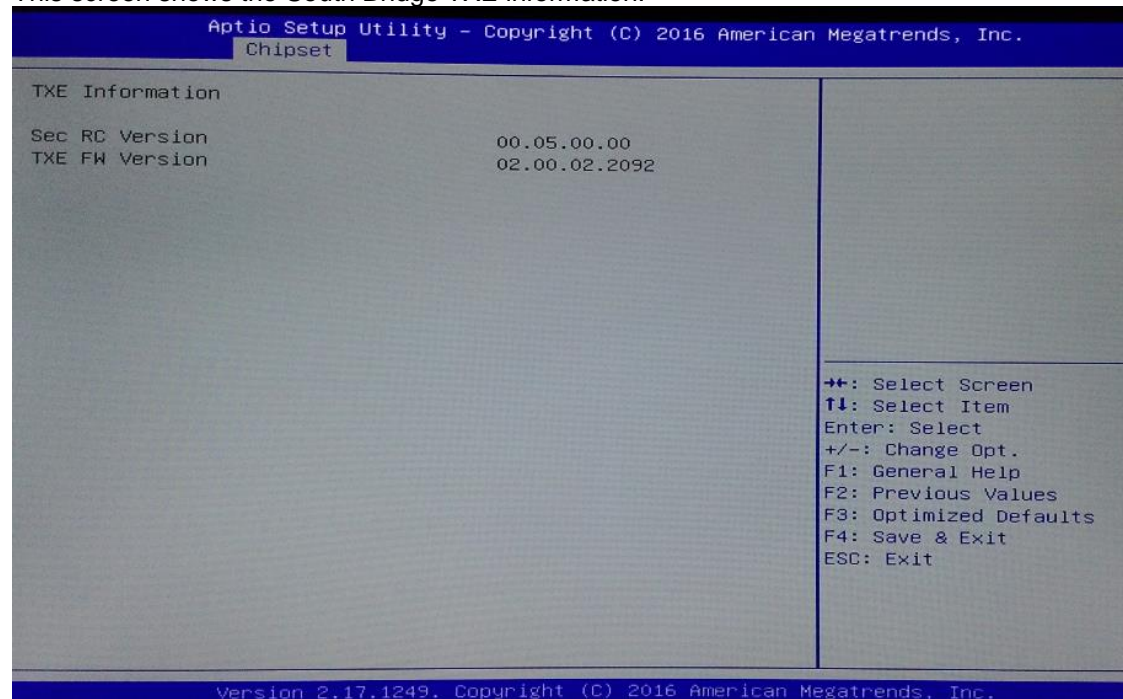

3.5 Security

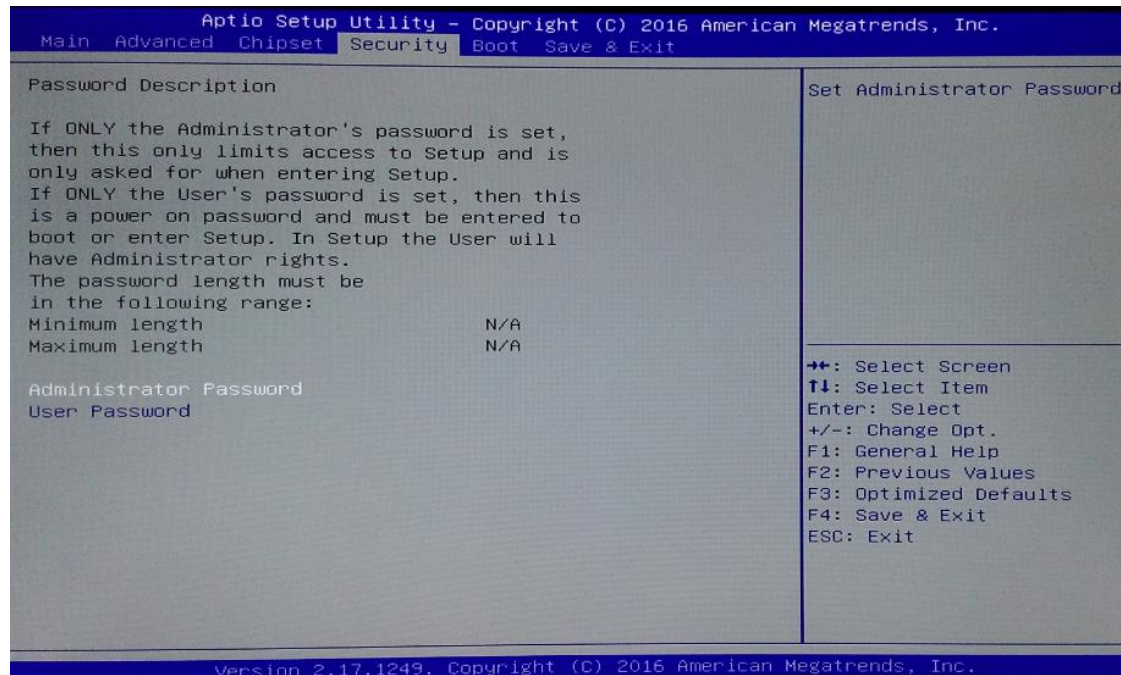

3.6 Boot Menu

The Boot menu allows users to change boot options of the system. You can select any of the items in the left frame of the screen to go to the sub menus:

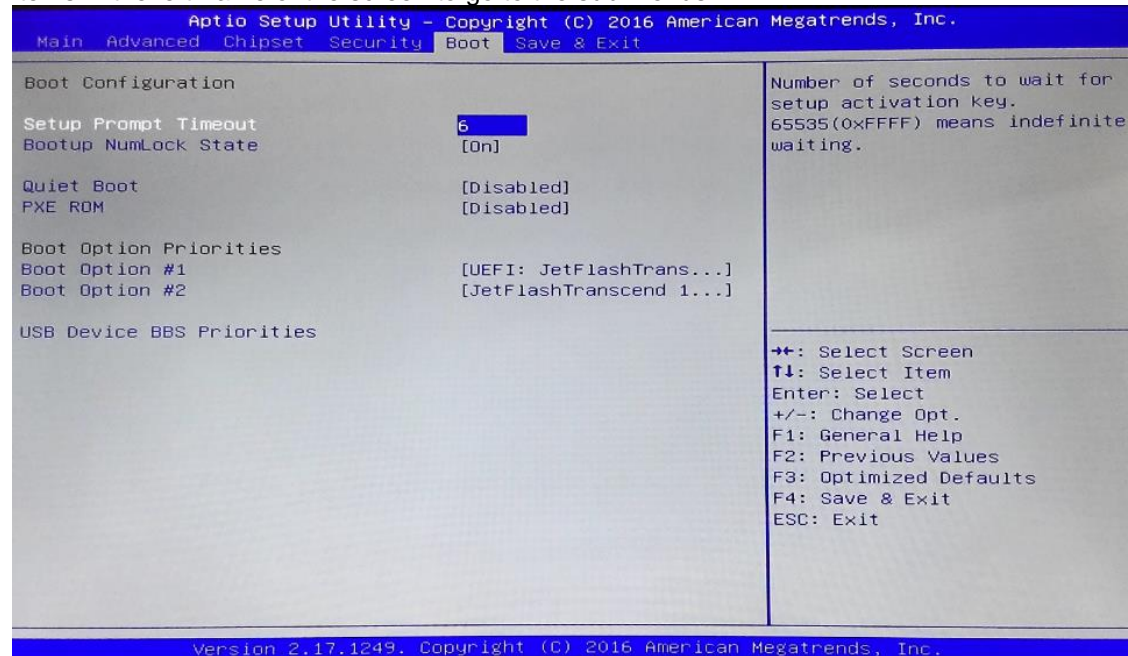

Setup Prompt Timeout

Set the Timeout for wait press key to enter Setup Menu

Bootup NumLock State

Use this item to select the power-on state for the NumLock. The default setting is on.

Quiet Boot

Use this item to enable or disable the Quite Boot state. The default setting is disable.

PXE ROM

Use this item to enable or disable the Preboot Execution Environment. The default setting is disable.

Boot Option Priorities

Specifies the overall boot order from the available devices.

3.7 Save & Exit

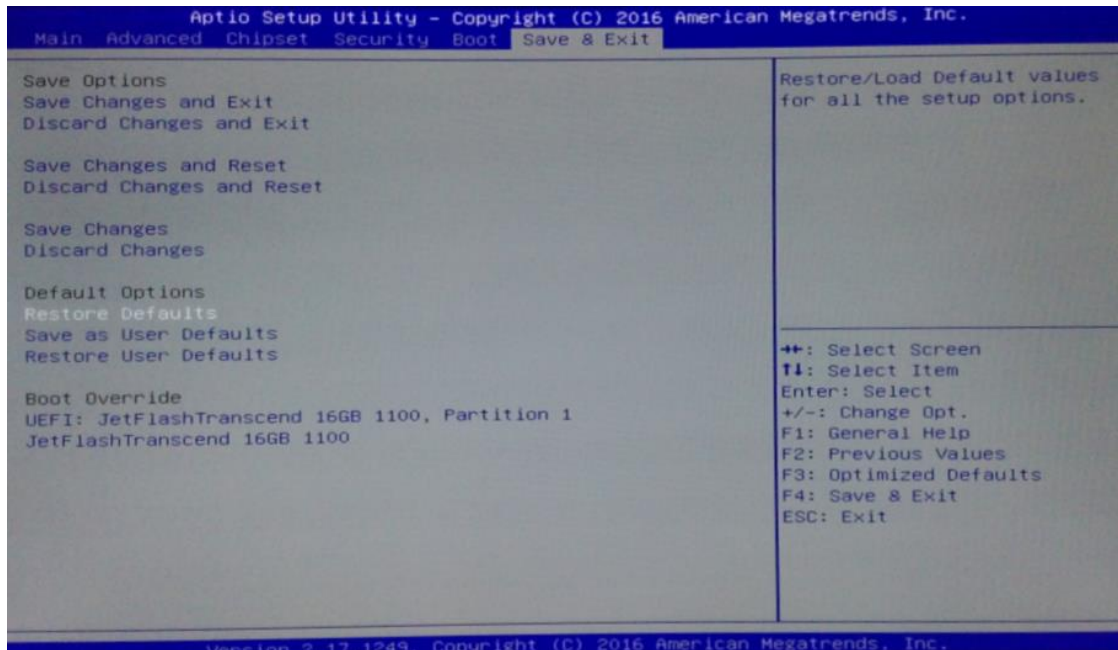

Chapter 4

Drivers Installation

4.1 System

MPC102-845 supports Windows 7, Windows 8/8.1 ,WES 7 and WE8S. To facilitate the installation of system driver, please carefully read the instructions in this chapter before start installing.

4.1.1 Win 7

1. Insert Driver CD and select the “\Drivers”.

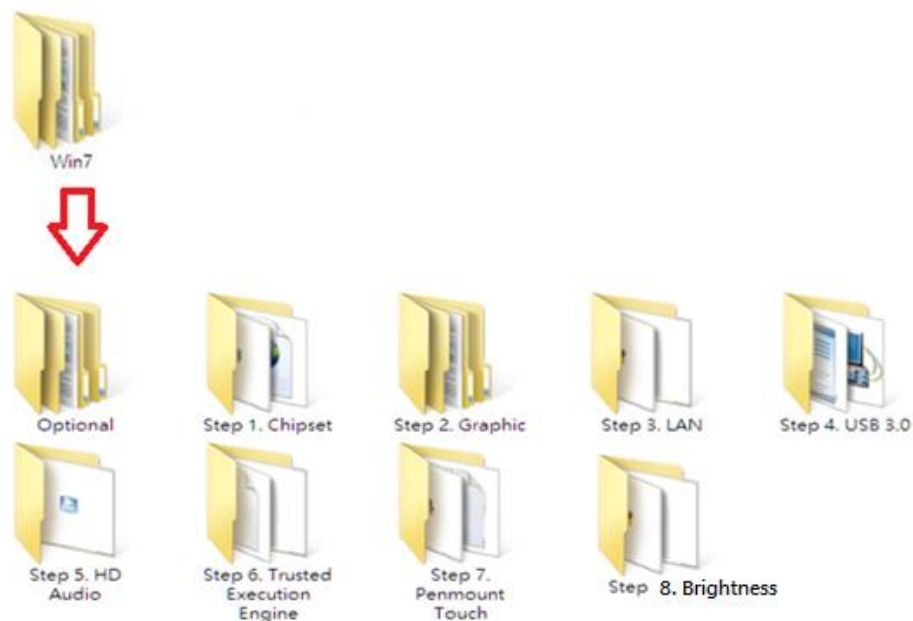

2. Select all files and follow the installing procedure.

CAUTION : Running the USB3.0 Utility before WIN 7 installation.

1. Download and unzip the Windows 7 USB 3.0 Creator utility to a temporary folder on the Admin system.
2. Connect the USB device containing the Windows 7 image to the Admin system.
3. Right-click the file **Installer_Creator.exe** and select **Run as administrator**.
4. Browse to the root of the USB drive.
5. Click **Create Image** to begin the creation process.
6. Wait for the process to finish. It can take up to 15 minutes.

4.1.2 Win 8/8.x

1. Insert Driver CD and select the "\Drivers".

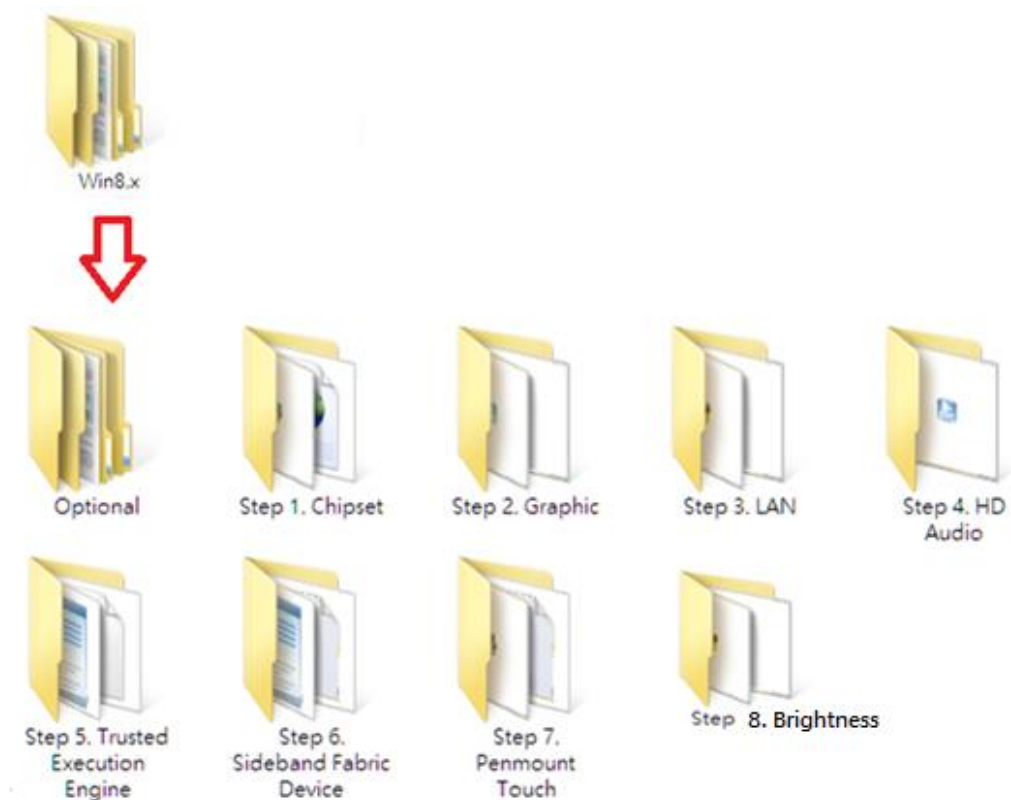

2. Select all files and follow the installing procedure.

4.2 Touch Screen

The MPC102-845 uses the 5-wire analog resistive. There are the specification and driver installation which are listed below.

4.2.1 Specification

Touch Screen	5-wire Analog Resistive type
Touch Screen Controller	PenMount 6000 USB Touch Screen Controller IC
Communications	USB interface
Resolution	800 x 600 /1024 x 1024
Power Input	5V
Power Consumption	Active: 24.6mA / Idle Mode: 13.4mA

4.2.2 Driver Installation- Windows 7/8.x

The MPC102-845 provides a touch screen driver that users can install it under the operating system Windows 7/8.x. To facilitate installation of the touch screen driver, you should read the instructions in this chapter carefully before you attempt installation.

1. Insert Driver CD and follow the path to select the “\Drivers\Step 7 - Touch”.

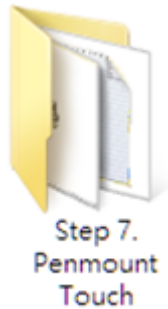

2. Follow the installing procedure and press OK.
3. Click Start menu and select “PenMount Utilities”; and then, a “PenMount Control Panel” pops out.

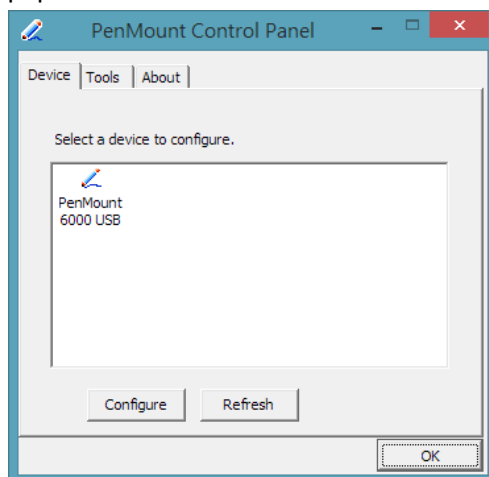

4. Select the "Standard Calibrate" tab.

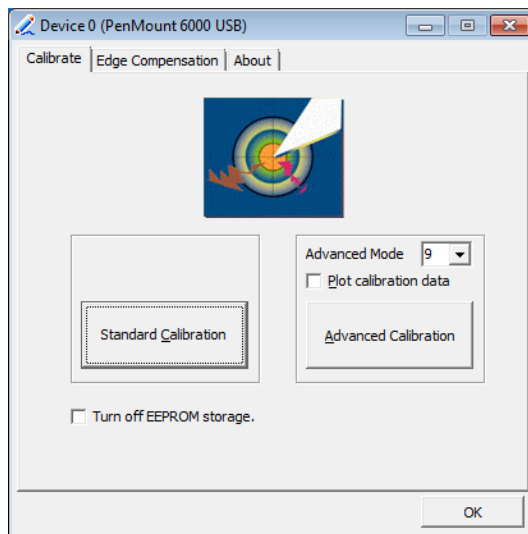

5. Calibration:

To adjust the display with touch panel, click "Calibration" and follow the calibrate point to do calibration; there are five points on screen for calibration.

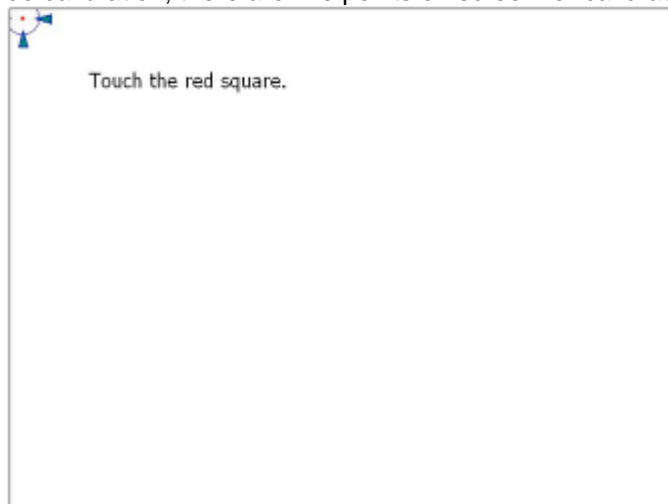

6. Press OK.

4.3 Embedded O.S.

The MPC102-845 provides the WES 7 and WE8S Embedded. The O.S. is supported devices which are listed below.

4.3.1 WES 7 & WE8S

Here are supported onboard devices:

- Onboard Multi I/O
- SATA HDD
- USB
- CRT/LCD display
- 10/100/1000 base-T Ethernet
- mSATA
- Onboard Audio
- Touch Screen