



®

AXIOMTEK

eBOX560-512-FL Series

Embedded System

User's Manual



Disclaimers

This manual has been carefully checked and believed to contain accurate information. Axiomtek Co., Ltd. assumes no responsibility for any infringements of patents or any third party's rights, or any liability arising from such uses.

Axiomtek does not warrant or assume any legal liability or responsibility for the accuracy, completeness or usefulness of any information in this document. Axiomtek does not make any commitment to update any information in this manual.

Axiomtek reserves the right to change or revise this document and/or product at any time without notice.

No part of this document may be reproduced, stored in a retrieval system, or transmitted in any forms or by any means, electronic, mechanical, photocopying, recording, among others, without prior written permissions of Axiomtek Co., Ltd.

©Copyright 2019 Axiomtek Co., Ltd.

All Rights Reserved

Dec 2019, Version A3

Printed in Taiwan

Safety Precautions

Before getting started, please read the following important safety precautions.

1. The eBOX560-512-FL does not come with an operating system which must be loaded first before installation of any software into the computer.
2. Be sure to ground yourself to prevent static charge when installing any internal components. Use a wrist grounding strap and place all electronic components in any static-shielded devices. Most electronic components are sensitive to static electrical charge.
3. Disconnect the power cord from the eBOX560-512-FL prior to making any installation. Be sure both the system and all external devices are turned OFF. Sudden surge of power could ruin sensitive components. Make sure the eBOX560-512-FL is properly grounded.
4. Make sure the voltage of the power source is correct before connecting it to any power outlet.
5. Turn Off system power before cleaning. Clean the system using a cloth only. Do not spray any liquid cleaner directly onto the screen.
6. Do not leave equipment in an uncontrolled environment where the storage temperature is below -20°C or above 80°C as it may damage the equipment.
7. Do not open the system's back cover. If opening the cover for maintenance is a must, only a trained technician is allowed to do so. Integrated circuits on computer boards are sensitive to static electricity. To avoid damaging chips from electrostatic discharge, observe the following precautions:
 - Before handling a board or integrated circuit, touch an unpainted portion of the system unit chassis for a few seconds. This will help discharge any static electricity on human body.
 - When handling boards and components, wear a wrist grounding strap available from most electronic component stores.
8. Note!! Caution with touch! eBOX560-512-FL will be hot when it's on.

Classification

1. Degree of protection against electric shock: not classified
2. Degree of protection against ingress of water: IP40
3. Equipment not suitable for use in the presence of a flammable anesthetic mixture with air, oxygen or nitrous oxide.
4. Mode of operation: Continuous

General Cleaning Tips

Please keep the following precautions in mind while understanding the details fully before and during any cleaning of the computer and any components within.

A piece of dry cloth is ideal to clean the device.

1. Be cautious of any tiny removable components when using a vacuum cleaner to absorb dirt on the floor.
2. Turn the system off before clean up the computer or any components within.
3. Avoid dropping any components inside the computer or getting circuit board damp or wet.
4. For cleaning, be cautious of all kinds of cleaning solvents or chemicals which may cause allergy to certain individuals.
5. Keep foods, drinks or cigarettes away from the computer.

Cleaning Tools:

Although many companies have created products to help improve the process of cleaning computer and peripherals, users can also use house hold items accordingly for cleaning. Listed below are items available for cleaning computer or computer peripherals.

Pay special attention to components requiring designated products for cleaning as mentioned below.

- Cloth: A piece of cloth is the best tool to use when rubbing up a component. Although paper towels or tissues can be used on most hardware as well, it is recommended to use a piece of cloth.
- Water or rubbing alcohol: A piece of cloth may be somewhat moistened with water or rubbing alcohol before being rubbed on the computer. Unknown solvents may be harmful to plastic parts.
- Absorb dust, dirt, hair, cigarette and other particles outside of a computer can be one of the best methods of cleaning a computer. Over time these items may restrict the airflow in a computer and cause circuitry to corrode.
- Cotton swabs: Cotton swaps moistened with rubbing alcohol or water are applicable to reach areas in keyboard, mouse and other areas.
- Foam swabs: If possible, it is better to use lint free swabs such as foam swabs.



【Note】 : *It is strongly recommended that customer should shut down the system before start to clean any single components.*

Please follow the steps below:

1. Close all application programs;
2. Close operating software;
3. Turn off power switch;
4. Remove all devices;
5. Pull out power cable.

Scrap Computer Recycling

If the computer equipment's needs the maintenance or are beyond repair, we strongly recommended that you should inform your Axiomtek distributor as soon as possible for the suitable solution. For the computers that are no longer useful or no longer working well, please contact your Axiomtek distributor for recycling and we will make the proper arrangement.

Trademarks Acknowledgments

Axiomtek is a trademark of Axiomtek Co., Ltd.

IBM, PC/AT, PS/2, VGA are trademarks of International Business Machines Corporation.

Intel[®] and Pentium[®] are registered trademarks of Intel Corporation.

MS-DOS, Microsoft C and QuickBasic are trademarks of Microsoft Corporation.

Windows 10, Linux and other brand names and trademarks are the properties and registered brands of their respective owners.

Table of Contents

Disclaimers.....	ii
Safety Precautions.....	iii
Classification.....	iv
General Cleaning Tips	v
Scrap Computer Recycling.....	vi
CHAPTER 1 INTRODUCTION	1
1.1 General Description.....	1
1.2 System Specifications	2
1.2.1 CPU	2
1.2.2 I/O System	2
1.2.3 System Specification.....	2
1.2.4 Driver CD Content.....	3
1.3 Dimensions	4
1.3.1 System Dimension.....	4
1.3.2 Wall mount Bracket Dimension.....	5
1.3.3 Din-rail mount Bracket Dimension.....	6
1.3.4 VESA mount Bracket Dimension.....	7
1.4 I/O Outlets.....	8
1.5 Packing List.....	9
1.6 Model List.....	9
CHAPTER 2 HARDWARE INSTALLATION.....	11
2.1 Installing the 2.5” SATA Device	11
2.2 Installing the Express Mini Card.....	13
2.3 Installing the SO-DIMM Memory	14
CHAPTER 3 JUMPER SETTING & CONNECTOR.....	15
3.1 Jumper & Connector Location.....	15
3.2 Jumper Setting Summary.....	17
3.2.1 Restore BIOS Optimal Defaults (JP1)	18
3.2.2 AT/ATX Quick Switch (SW1)	18
3.3 Connectors.....	19
3.3.1 DC Power Jack w/ Screw	20
3.3.2-1 Ethernet Port (PICO512-CN13)	20
3.3.2-2 Ethernet Port (AX93A01-CN4).....	20
3.3.3-1 HDMI Connector (PICO512-CN15).....	21
3.3.3-2 HDMI Connector (AX93A01-CN8)	21
3.3.4 COM Serial Port Connector	22
3.3.5 USB 3.0 Connector	23
3.3.6 System Power Switch.....	23
3.3.7 System Reset Button.....	23
3.3.8 Power and HDD LED Indicator	24
3.3.9 Express Mini Card Slot.....	24
3.3.10 ATX/AT Quick switch.....	25

CHAPTER 4 BIOS SETUP UTILITY	27
4.1 Starting.....	27
4.2 Navigation Keys.....	27
4.3 Main Menu	28
4.4 Advanced Menu	29
4.5 Chipset Menu	39
4.6 Security Menu	46
4.7 Boot Menu	47
4.8 Save & Exit Menu.....	48
APPENDIX A WATCHDOG TIMER.....	51
About Watchdog Timer	51
How to Use Watchdog Timer	51
APPENDIX B BIOS Flash Utility	53
APPENDIX C iAMT Settings	57
C.1 Entering MEBx	57
C.2 Set and Change Password	57
C.3 iAMT Settings	59
C.4 iAMT Web Console.....	64

CHAPTER 1

INTRODUCTION

This chapter contains general information and detailed specifications of the eBOX560-512-FL. The Chapter 1 includes the following sections:

- General Description
- System Specifications
- Dimensions
- I/O Outlets
- Packing List
- Model List

1.1 General Description

The eBOX560-512-FL is an embedded system that supports Intel® Core™ i5-7300U, 3.5 GHz / Celeron® 3965U, 2.2GHz onboard to support Windows 10, AXVIEW 2.0 and Linux, suitable for the most enduring operation.

It features fan less design with full feature I/O, one 260-pin unbuffered SODIMM socket for one channel DDR4-2133 MHz memory, and enhanced system dependability by built-in Watchdog Timer.

- **Features**

1. 7th generation Intel® Core™ i5-7300U,3.5GHz / Celeron® 3965U,2.2GHz ULT SoC
2. Maximum up to 16 GB SO-DIMM DDR4- 2133 MHz memory capacity
3. Ultra-compact enclosure and wide rang power input
4. 1 PCI Express Mini Card slot and 4 USB 3.0
5. One 2.5" SATA HDD and mSATA interface
6. Two HDMI with Dual view
7. AXView 2.0 supported

- **Reliable and Stable Design**

The eBOX560-512-FL adopts the advanced cooling system and supporting the mSATA, which makes it especially suitable for vibration environments, best for industrial automation, digital signage and gaming application.

- **Embedded O.S. Supported**

The eBOX560-512-FL not only supports Windows 10, Windows 10 IoT and Linux but also supports embedded OS.

- **Various Storage devices supported**
For storage device, the eBOX560-512-FL supports one 2.5" SATA storage drive bay and one mSATA device.

1.2 System Specifications

1.2.1 CPU

- **CPU**
 - 7th generation Intel® Core™ i5-7300U,3.5GHz / Celeron® 3965U,2.2GHz ULT SoC
- **Chipset**
 - SoC integrated
- **BIOS**
 - American Megatrends Inc. UEFI (Unified Extensible Firmware Interface) BIOS.
- **System Memory**
 - One 260-pin unbuffered DDR4-2133 MHz SO-DIMM socket, max. up to 16 GB

1.2.2 I/O System

- Two jumper-less RS-232/422/485 9-pin D-Sub male connector (COM1/COM2)
- Two HDMI for display
(2 x HDMI 1.4 Resolution: up to 4096 x 2160@24Hz)
- Two RJ-45 connectors for 10/100/1000 Base-T Ethernet ports (i210AT & i219LM)
- Four USB 3.0 connectors
- One PCI Express Mini Card Slots w/ mSATA supported.
- One ATX Power switch
- Two Indicators LED (System Power, HDD Active)
- One AT/ATX Quick switch
- Two SMA type connector opening for Antenna
- 12 VDC Power jack connector

1.2.3 System Specification

- **Watchdog Timer**
 - 1~255 seconds or minutes; up to 255 levels..
- **Power Supply**
 - Input : 12VDC
- **Operation Temperature**
 - -10°C ~+50°C (-14°F~+122°F), with W.T. SSD & Memory
- **Storage Temperature**
 - -20°C ~ 80°C (-40 °F ~ 176°F)
- **Humidity**
 - 10% ~ 90% (non-condensation)

- **Vibration Endurance**
 - 3Grms w/ SSD (5-500Hz, X, Y, Z directions)
- **Weight**
 - 0.8 kg(1.76lb) without package
 - 1.67 kg(3.68lb) with package
- **Dimensions**
 - 141.6 mm(5.57") (W) x 106 mm(4.17") (D) x 54.85 mm(2.15") (H)

1.2.4 Driver CD Content

- **Driver**
 - Chipset
 - Ethernet
 - Graphic
 - ME
- **Manual**
 - User Manual
 - Quick Manual



Note: All specifications and images are subject to change without notice.

1.3 Dimensions

The following diagrams show you dimensions and outlines of the eBOX560-512-FL.

1.3.1 System Dimension

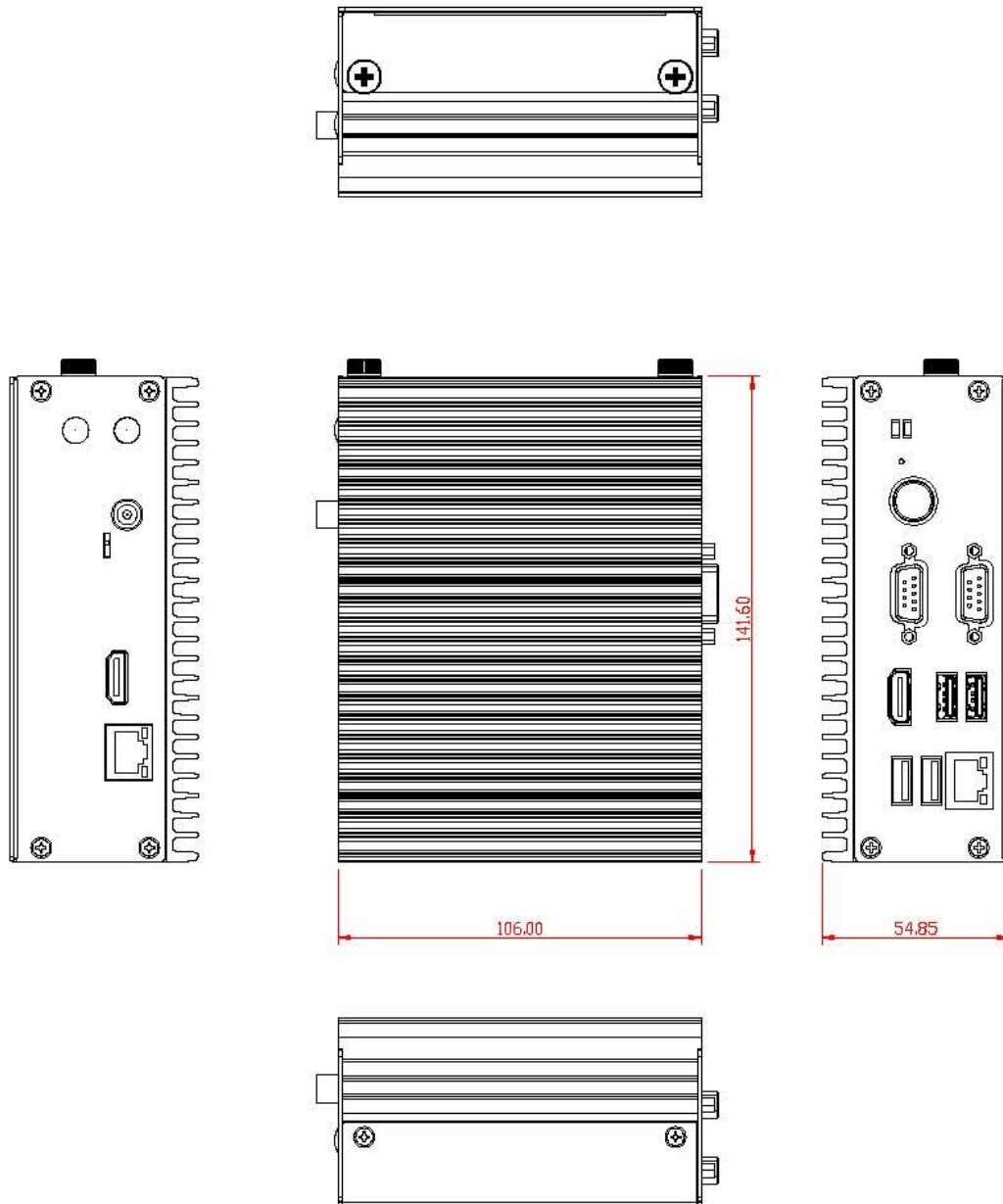

1.3.2 Wall mount Bracket Dimension

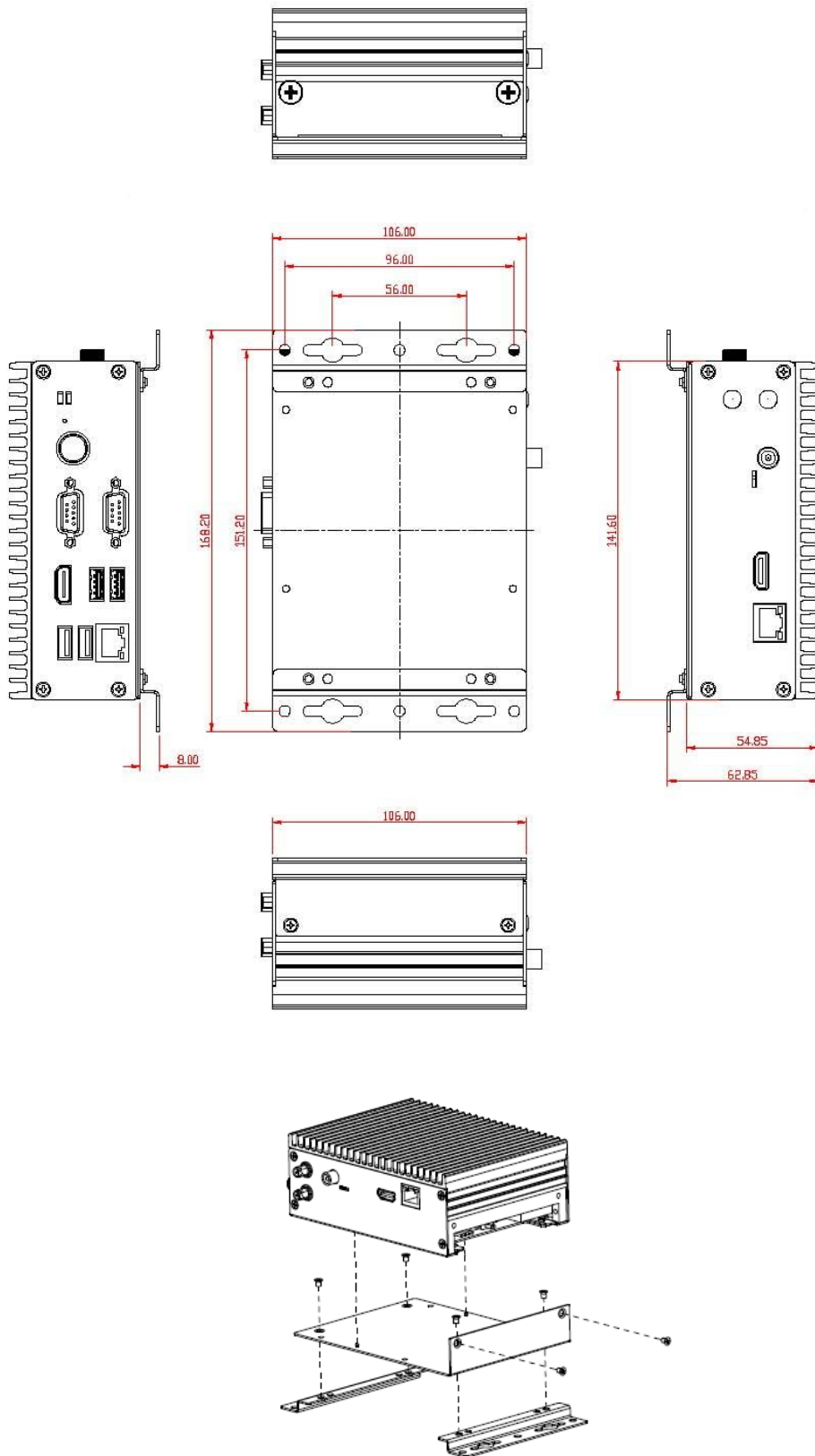

1.3.3 Din-rail mount Bracket Dimension

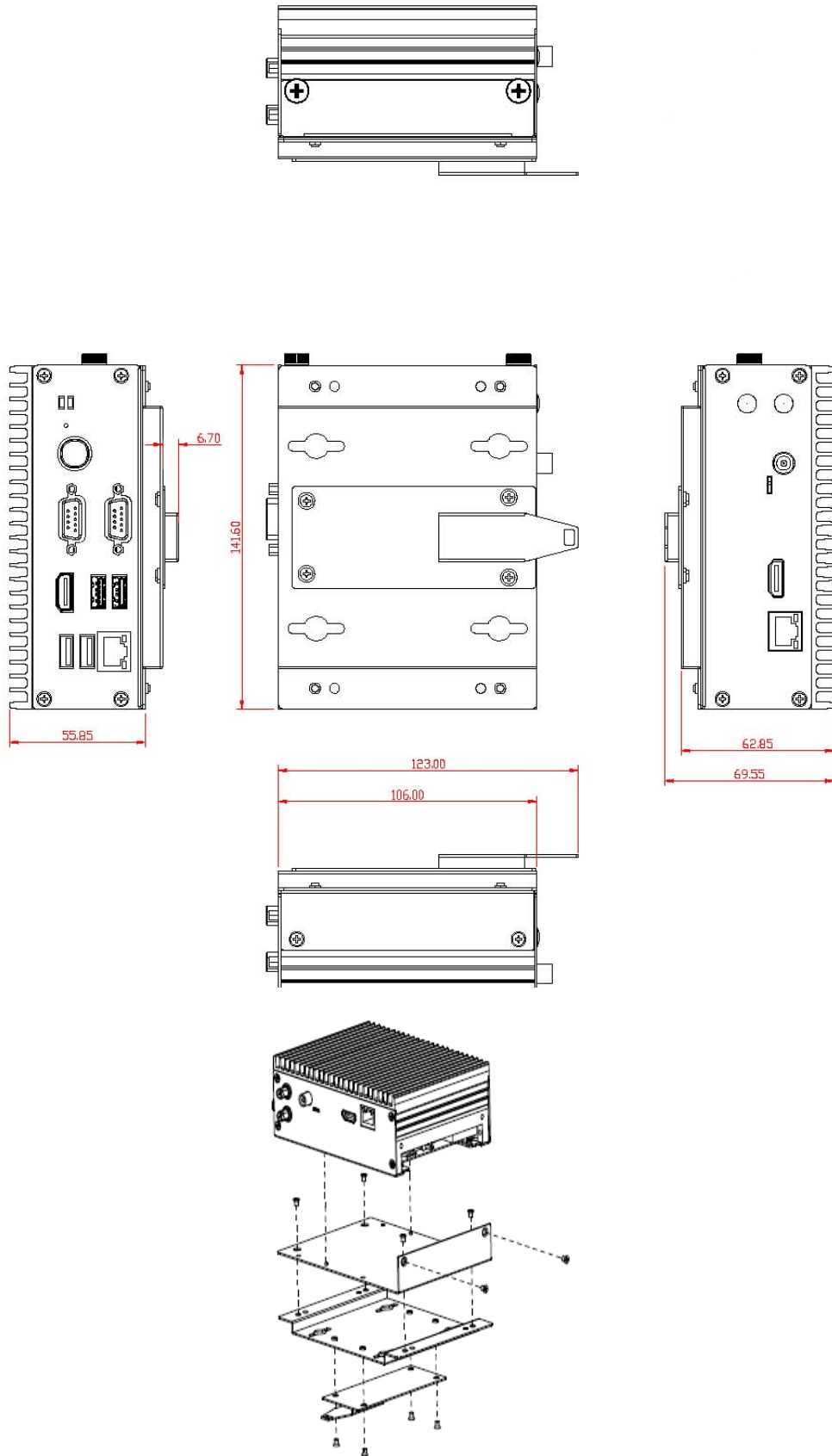

1.3.4 VESA mount Bracket Dimension

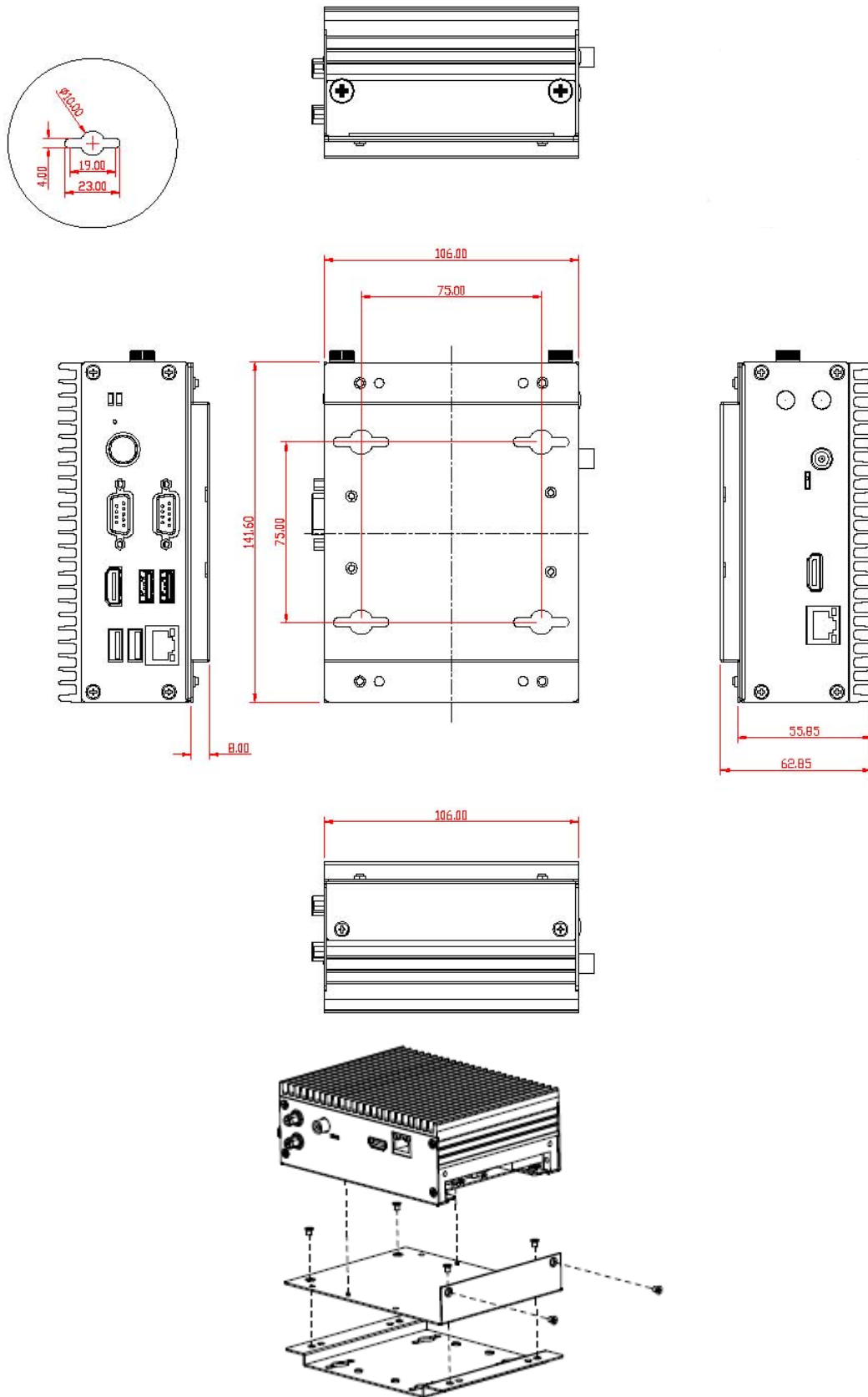

1.4 I/O Outlets

The following figures show you I/O outlets on front view of the eBOX560-512-FL.

- Front View drawing

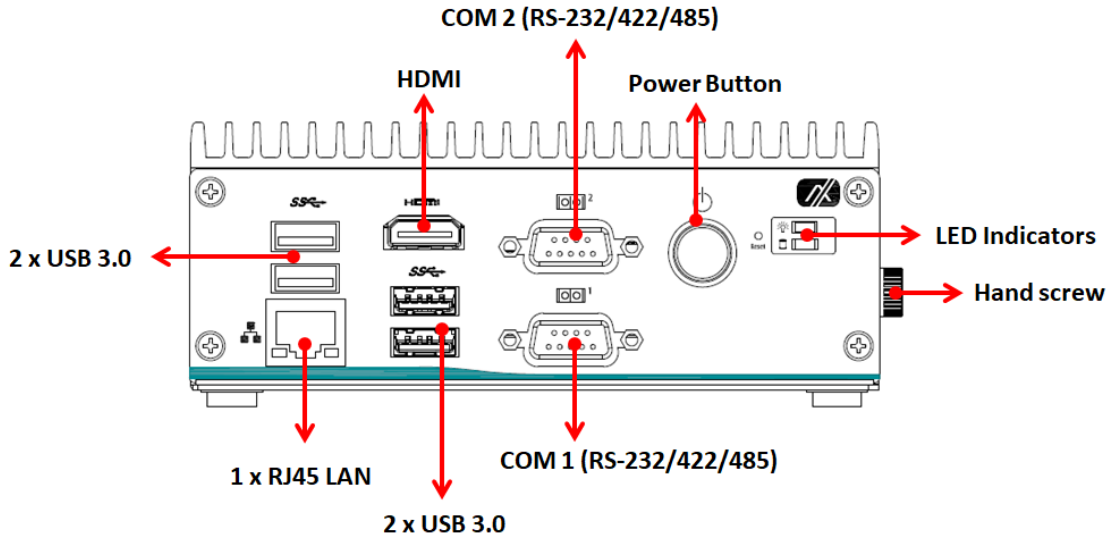

- Rear View drawing

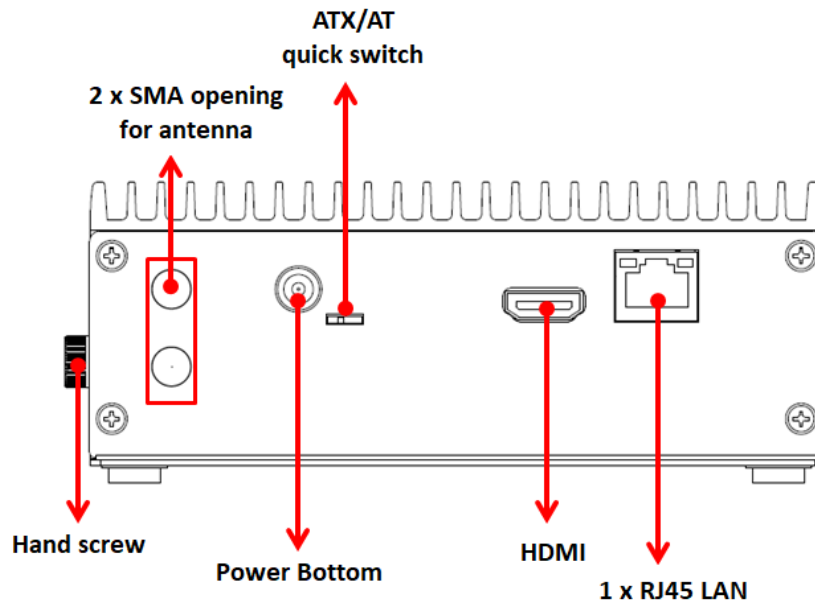

1.5 Packing List

The package bundled with your eBOX560-512-FL should contain the following items:

- eBOX560-512-FL System Unit x 1
- eBOX560-512-FL Quick Installation Guide x 1
- DVD x 1 (For Driver and Manual)
- Screws Pack x 1
- Foot pad x 4
- Optional 12VDC / 60W AC to DC Adapter
- Optional Power cord

1.6 Model List

eBOX560-512-FL-DC-3965U	Fanless Embedded System with Intel® Core™ Celeron-3965U Kaby Lake Processor , 2 x HDMI , 2 GbE LAN, 4 USB 3.0 , 2 COM and PCIe Mini Card (w/o adapter and power cord)
eBOX560-512-FL-DC-7100U	Fanless Embedded System with Intel® Core™ i3-7100U Kaby Lake Processor , 2 x HDMI , 2 GbE LAN, 4 USB 3.0 , 2 COM and PCIe Mini Card (w/o adapter and power cord)
eBOX560-512-FL-DC-7300U	Fanless Embedded System with Intel® Core™ i5-7300U Kaby Lake Processor , 2 x HDMI , 2 GbE LAN, 4 USB 3.0 , 2 COM and PCIe Mini Card (w/o adapter and power cord)

If you cannot find this package or any items are missing, please contact Axiomtek distributors immediately.

This page is intentionally left blank.

CHAPTER 2 HARDWARE INSTALLATION

The eBOX560-512-FL is convenient for your various hardware configurations, such as DRAM, HDD (Hard Disk Drive), SSD (Solid State Drive) or PCI Express Mini Card modules. The chapter 2 will show you how to install the hardware.

2.1 Installing the 2.5" SATA Device

Step 1 Turn off the system, and unplug the power adaptor.

Step 2 Locate screws at the right side, loosen the two screws.

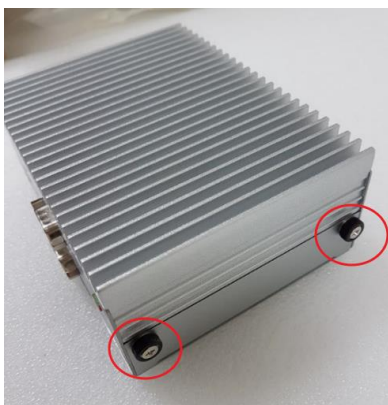

Step 3 Pull out the HDD drive bay bracket.



Step 4 Please prepare the following items to assemble HDD/SSD.



Step 5 Fasten total four screws to fix HDD/SSD.



Step 6 Connected the SSD directly and make sure the insertion is complete and fasten two screws.



【Note】 : Please notice the direction of connector for HDD.



2.2 Installing the Express Mini Card

Step 1 Turn off the system, and unplug the power adaptor.

Step 2 Turn the system upside down to locate screws at the right side as red marked and loosen two screws.



Step 3 Remove the bottom cover and then pull out the HDD bracket.

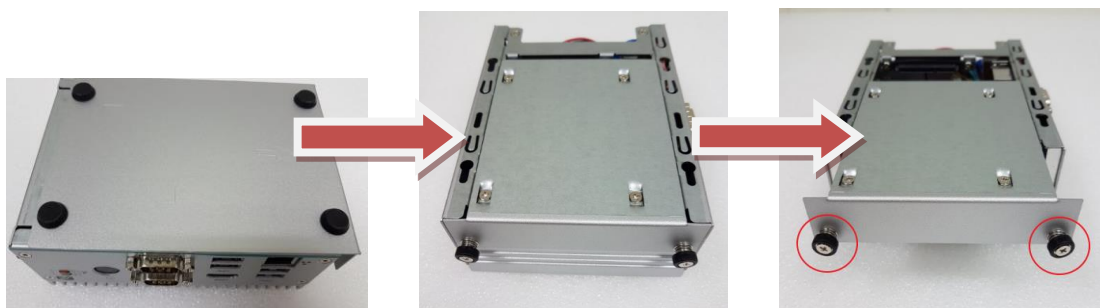

Step 4 Remove the bracket within the red line as marked.

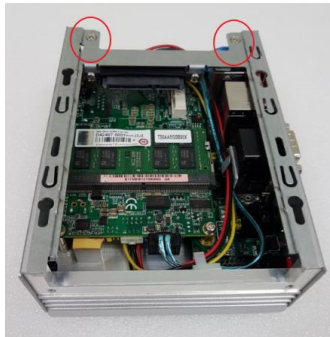

Step 5 Slide Mini Card into Mini Card slot with caution, and then fasten screw of Express Mini Card and finally connect the RF cable.

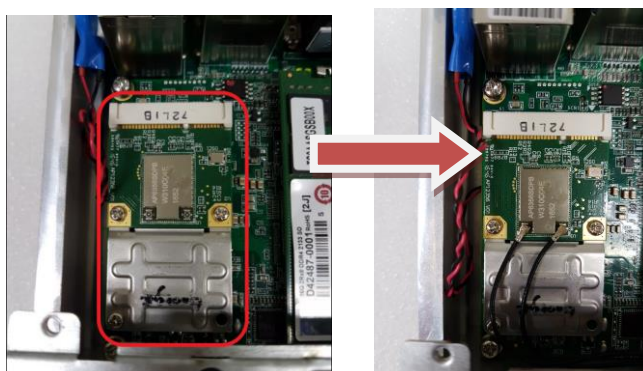

Step 6 Assemble the bottom cover and HDD bracket back and fasten all screws.

2.3 Installing the SO-DIMM Memory

Step 1 Turn off the system, and unplug the power adaptor.

Step 2 Turn the system upside down to locate screws at the right side as red marked and loosen two screws.



Step 3 Remove the bottom cover and then pull out the HDD bracket.

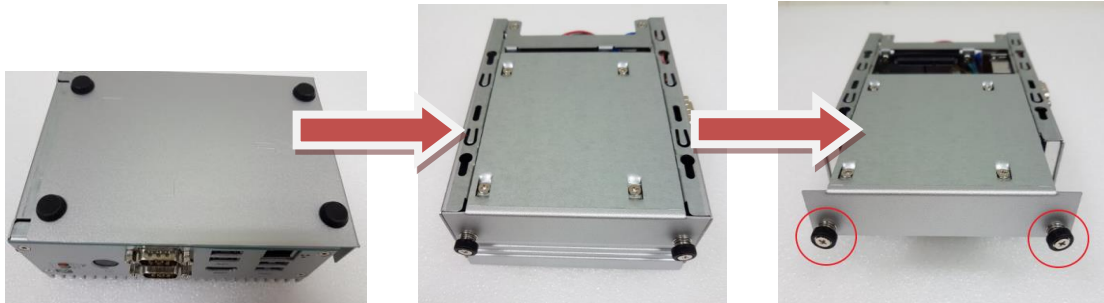

Step 4 Located the dual SO-DIMM sockets on main board.

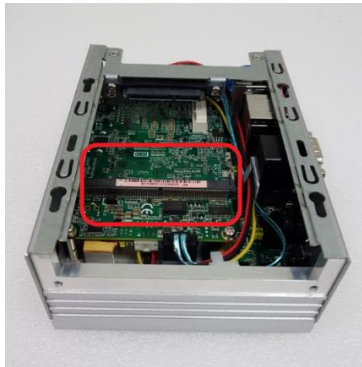

Step 5 Locate the memory module, insert a gold colored contact into the socket and push the module two end latches till locked and then put the HDD bracket and bottom cover back.

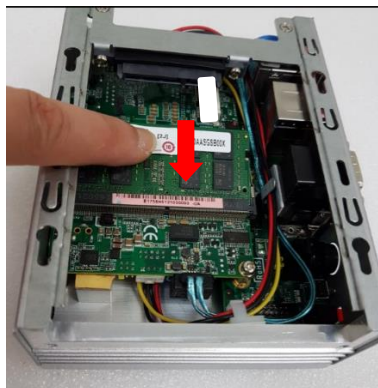

CHAPTER 3 JUMPER SETTING & CONNECTOR

Proper jumper settings configure the eBOX560-512-FL to meet your application purpose. We are here with listing a summary table of all jumpers and default settings for onboard devices, respectively.

3.1 Jumper & Connector Location

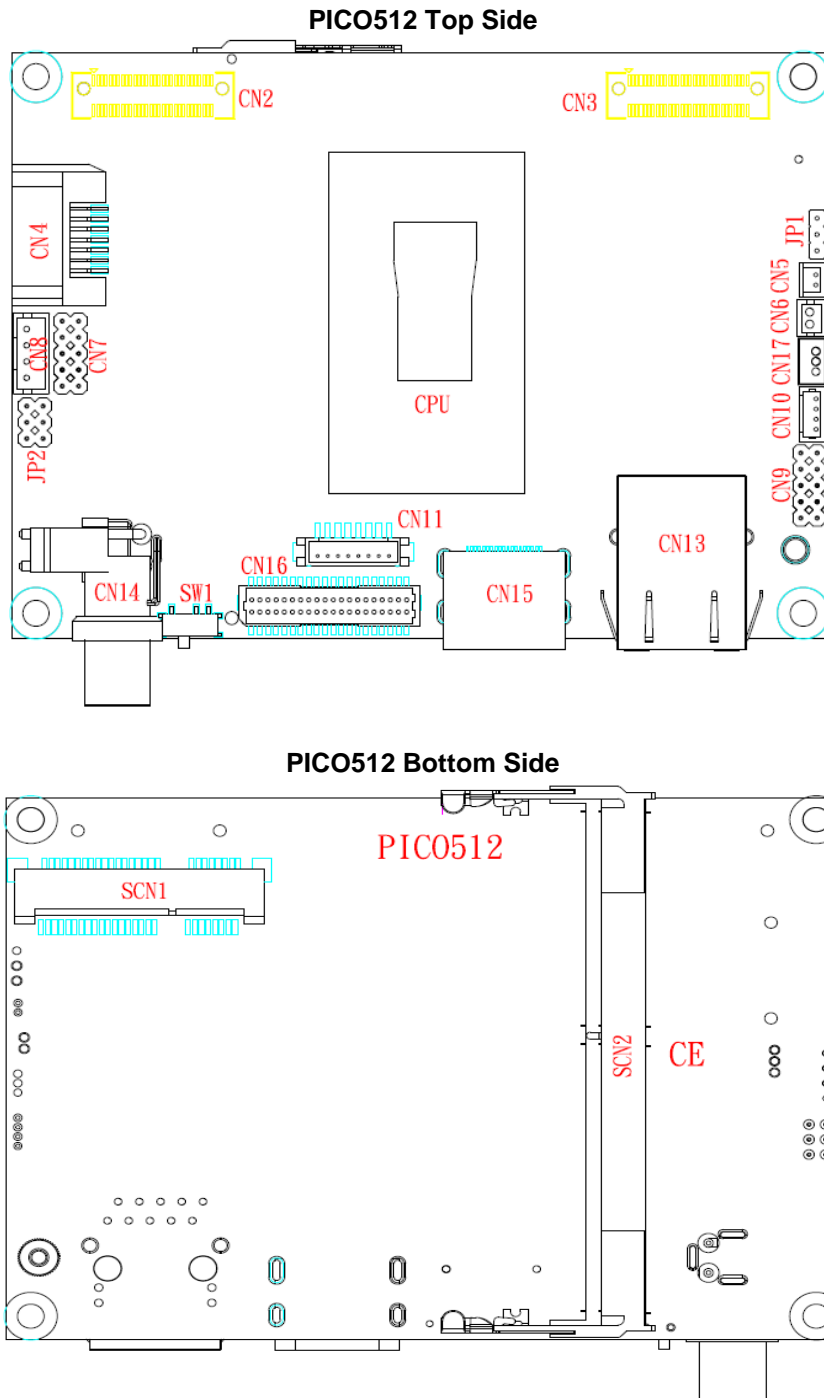

AX93A01 Top View

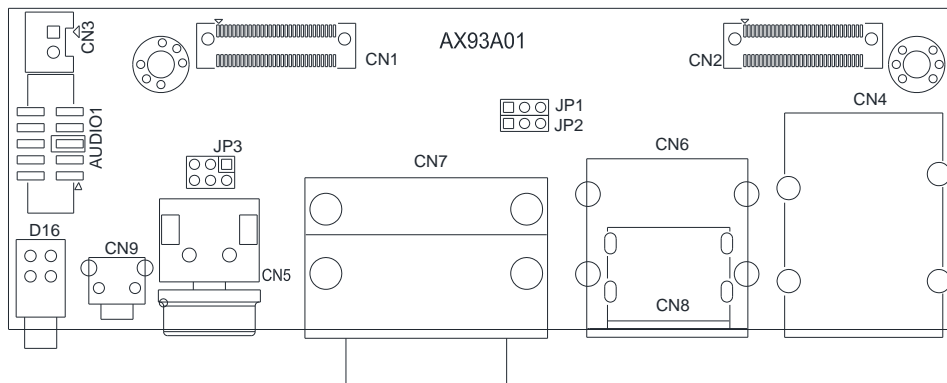

AX93A01 Side View

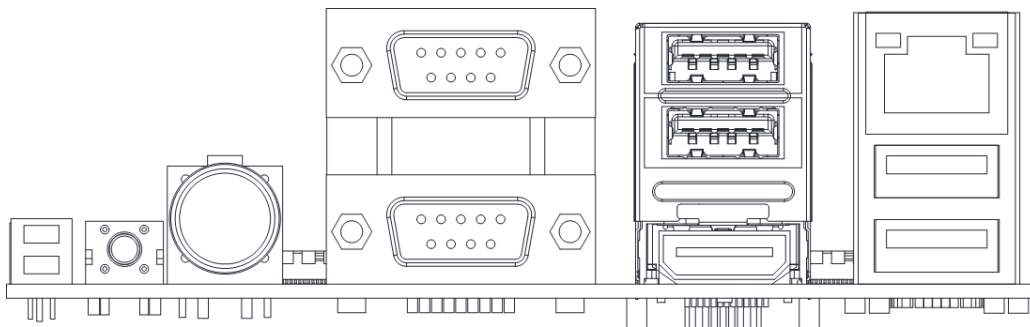

Note: We strongly recommended that you should not modify any unmentioned jumper setting without Axiomtek FAE's instruction. Any modification without instruction might cause system to become damage.

3.2 Jumper Setting Summary

Proper jumper settings configure the eBOX560-512-FL to meet your application purpose. We are herewith listing a summary table of all jumpers and default settings for onboard devices, respectively.

PICO512:

Jumper & Switch	Descriptions	Settings
JP1	Restore BIOS Optimal Defaults Default: Normal Operation	1-2 Close
SW1	Auto Power On Default: Disable	ATX

AX93A01 I/O Board:

Jumpers	Descriptions	Settings	
JP1	USB port 0 and 1 Power Selection	+5V_SBY (Default)	1-2 Close
		+5V	2-3 Close
JP2	USB port 2 and 3 Power Selection	+5V_SBY (Default)	1-2 Close
		+5V	2-3 Close
JP3	COM1 Data/Power Selection	Power: Set COM1 pin 1 to +5V level	1-3 Close
		RS-232 Data: Set COM1 pin 1 to DCD (Default)	3-5 Close
		Power: Set COM1 pin 9 to +12V level	2-4 Close
		RS-232 Data: Set COM1 pin 9 to RI (Default)	4-6 Close



Note: How to setup Jumpers

The illustration shows how to set up jumpers. When the jumper cap is placed on pins, the jumper is “close”, if not, that means the jumper is “open”.



[Open]



[Closed]



[Pin1-2 Closed]

3.2.1 Restore BIOS Optimal Defaults (JP1)

Put jumper clip to pin 2-3 for a few seconds then move it back to pin 1-2. Doing this procedure can restore BIOS optimal defaults.

Functions	Settings
Normal (Default)	1-2 close
Restore BIOS optimal defaults	2-3 close



3.2.2 AT/ATX Quick Switch (SW1)

If SW1 is enabled for power input, the system will be automatically power on without pressing soft power button. If SW1 is disabled for power input, it is necessary to manually press soft power button to power on the system.

Functions	Settings
Disable auto power on (Default)	ATX
Enable auto power on	AT



3.3 Connectors

Connectors connect the board with other parts of the system. Loose or improper connection might cause problems. Make sure all connectors are properly and firmly connected. Here is a summary table shows you all connectors and button on the **eBOX560-512-FL** Series.

External Connectors / Buttons	PCB Location	Section
DC Power Jack w/ Screw	PICO512-CN14	3.3.1
LAN Port	PICO512-CN13	3.3.2-1
	AX93A01-CN4	3.3.2-2
HDMI Connector	PICO512-CN15	3.3.3-1
	AX93A01-CN8	3.3.3-2
COM Serial Port Connector	AX93A01-CN7	3.3.4
USB 3.0 Connector	AX93A01-CN4/CN6	3.3.5
System Power Button	AX93A01-CN5	3.3.6
System Reset Button	AX93A01-CN9	3.3.7
Power and HDD LED Indicator	AX93A01-D16	3.3.8
PCI Express Mini Card interface	PICO512-SCN1	3.3.9
ATX/AT Quick switch	PICO512-SW1	3.3.10

3.3.1 DC Power Jack w/ Screw

The CN14 is a DC jack with screw. Firmly insert at least 60W adapter into this connector. Loose connection may cause system instability and make sure all components/devices are properly installed before connecting.

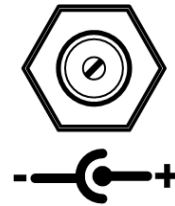

3.3.2-1 Ethernet Port (PICO512-CN13)

The CN13 Connector is on PICO512. Connection can be established by plugging one end of the Ethernet cable into this RJ-45 connector and the other end (phone jack) to a 1000/100/10 Base-T hub.

Pins	Signals	Pins	Signals
L1	MDI0P	L5	MDI2P
L2	MDI0N	L6	MDI2N
L3	MDI1P	L7	MDI3P
L4	MDI1N	L8	MDI3N
A	Active LED (Yellow)		
B	1000 LAN LED (Orange) / 100 LAN LED (Green)		

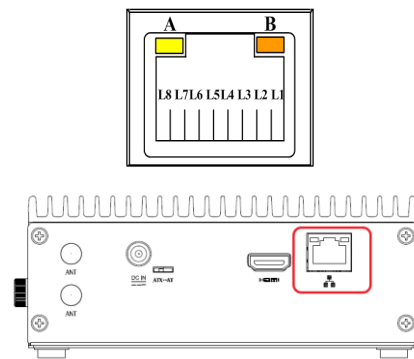

3.3.2-2 Ethernet Port (AX93A01-CN4)

The CN4 Connector is on AX93A01. Connection can be established by plugging one end of the Ethernet cable into this RJ-45 connector and the other end (phone jack) to a 1000/100/10-Base-T hub.

Pins	Signals	Pins	Signals
L1	MDI0P	L5	MDI2P
L2	MDI0N	L6	MDI2N
L3	MDI1P	L7	MDI3P
L4	MDI1N	L8	MDI3N
A	Active LED (Yellow)		
B	1000 LAN LED (Orange) / 100 LAN LED (Green)		

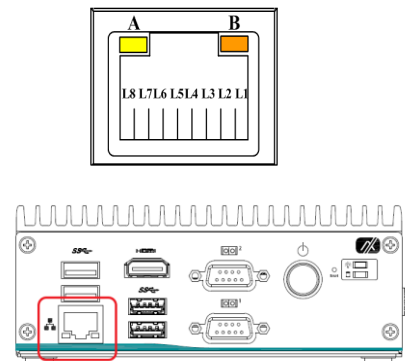

3.3.3-1 HDMI Connector (PICO512-CN15)

The HDMI (High-Definition Multimedia Interface) is a compact digital interface which is capable of transmitting high-definition video and high-resolution audio over a single cable.

Pins	Signals	Pins	Signals
1	HDMI OUT_DATA2+	2	GND
3	HDMI OUT_DATA2-	4	HDMI OUT_DATA1+
5	GND	6	HDMI OUT_DATA1-
7	HDMI OUT_DATA0+	8	GND
9	HDMI OUT_DATA0-	10	HDMI OUT_Clock+
11	GND	12	HDMI OUT_Clock-
13	N.C.	14	N.C.
15	HDMI OUT_SCL	16	HDMI OUT_SDA
17	GND	18	+5V
19	HDMI_HTPLG		

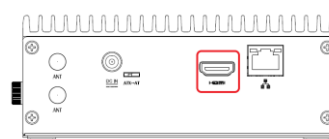
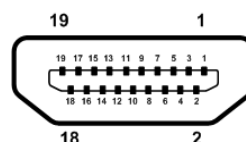

3.3.3-2 HDMI Connector (AX93A01-CN8)

The HDMI (High-Definition Multimedia Interface) is a compact digital interface which is capable of transmitting high-definition video and high-resolution audio over a single cable.

Pins	Signals	Pins	Signals
1	HDMI OUT_DATA2+	2	GND
3	HDMI OUT_DATA2-	4	HDMI OUT_DATA1+
5	GND	6	HDMI OUT_DATA1-
7	HDMI OUT_DATA0+	8	GND
9	HDMI OUT_DATA0-	10	HDMI OUT_Clock+
11	GND	12	HDMI OUT_Clock-
13	N.C.	14	N.C.
15	HDMI OUT_SCL	16	HDMI OUT_SDA
17	GND	18	+5V
19	HDMI_HTPLG		

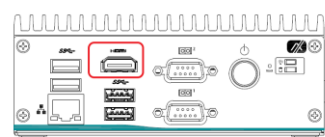
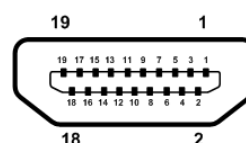

3.3.4 COM Serial Port Connector

The system has two serial ports. COM1 and COM2 are RS-232/422/485 ports. Please refer to Chapter 4 for the detail of BIOS setting.

COM1	RS-232	RS-422	RS-485
1	DCD, Data Carrier Detect	TX-	Data-
2	RXD, Receive Data	TX+	Data+
3	TXD, Transmit Data	RX+	No use
4	DTR, Data Terminal Ready	RX-	No use
5	GND, Ground	No use	No use
6	DSR, Data Set Ready	No use	No use
7	RTS, Request To Send	No use	No use
8	CTS, Clear To Send	No use	No use
9	RI, Ring Indicator	No use	No use

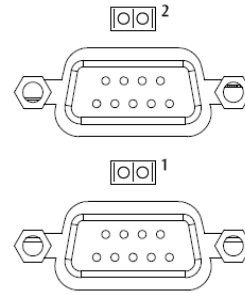

COM2	Signal
1	Data Carrier Detect (DCD)
2	Receive Data (RXD)
3	Transmit Data (TXD)
4	Data Terminal Ready (DTR)
5	Ground (GND)
6	Data Set Ready (DSR)
7	Request to Send (RTS)
8	Clear to Send (CTS)
9	Ring Indicator (RI)

3.3.5 USB 3.0 Connector

The Universal Serial Bus connectors are compliant with USB 3.0 (5Gb/s), and ideally for installing USB peripherals such as keyboard, mouse, scanner, etc.

Pins	Signal USB Port 0	Pins	Signal USB Port 1
1	USB_VCC (+5V level standby power)	10	USB_VCC (+5V level standby power)
2	USB_Data2-	11	USB_Data3-
3	USB_Data2+	12	USB_Data3+
4	GND	13	GND
5	SSRX2-	14	SSRX3-
6	SSRX2+	15	SSRX3+
7	GND	16	GND
8	SSTX2-	17	SSTX3-
9	SSTX2+	18	SSTX3+

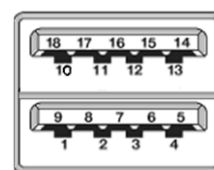

3.3.6 System Power Switch

This button is for turning on/off the system power.

Functions	Descriptions
On	Turn on/off system
Off	Keep system status

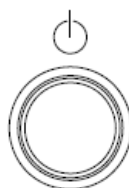

3.3.7 System Reset Button

This button reboots your computer without turning off the power supply. It is a better way to reboot your system for a longer life of the system power supply.

Function	Description
On	Reset system
Off	Keep system status

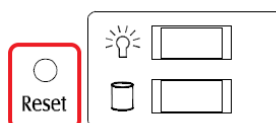

3.3.8 Power and HDD LED Indicator

The Red LED is linked to Hard Disk Drive (HDD) activity signal. LED flashes every time HDD is accessed.

The power LED (green) lights up and will remain steady while the system is powered on.

LED Color	Description
Green	Power on/off
Red	Hard disk drive activity



3.3.9 Express Mini Card Slot

This is a full-size PCI-Express Mini Card connector on the bottom side complying with PCI-Express Mini Card Spec. V1.2. It supports either PCI-Express, USB 2.0 or SATA (mSATA). To enable or disable mSATA support, please refer to BIOS setting in section 4.4.

Pins	Signals	Pins	Signals
1	WAKE#	2	+V3.3_SBY
3	No use	4	GND
5	No use	6	+1.5V
7	CLKREQ#	8	No use
9	GND	10	No use
11	REFCLK-	12	No use
13	REFCLK+	14	No use
15	GND	16	No use
17	No use	18	GND
19	No use	20	W_DISABLE#
21	GND	22	PERST#
23	PE_RXN/SATA_RXP	24	+V3.3_SBY
25	PE_RXP/SATA_RXN	26	GND
27	GND	28	+1.5V
29	GND	30	SMB_CLK
31	PE_TXN/SATA_TXN	32	SMB_DATA
33	PE_TXP/SATA_TXP	34	GND
35	GND	36	USB_D4-
37	GND	38	USB_D4+
39	+V3.3_SBY	40	GND
41	+V3.3_SBY	42	No use
43	GND	44	No use
45	No use	46	No use
47	No use	48	+1.5V
49	No use	50	GND
51	No use	52	+V3.3_SBY

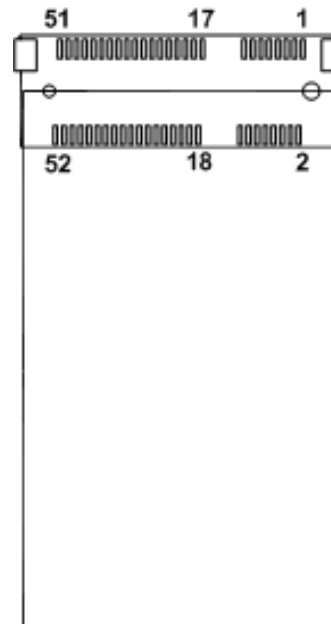

3.3.10 ATX/AT Quick switch

If users set AT/ATX switch to AT mode, the system will be automatically power on without pressing soft power button during power input; users can use this switch to achieve auto power on demand. (Default : ATX mode)



This page is intentionally left blank.

CHAPTER 4 BIOS SETUP UTILITY

This chapter provides users with detailed description how to set up basic system configuration through the BIOS setup utility.

4.1 Starting

To enter the setup screens, follow the steps below:

1. Turn on the computer and press the key immediately.
2. After press the key, the main BIOS setup menu displays. Users can access to other setup screens, such as the Advanced and Chipset menus, from the main BIOS setup menu.

It is strongly recommended that users should avoid changing the chipset's defaults. Both AMI and system manufacturer have carefully set up these defaults that provide the best performance and reliability.

4.2 Navigation Keys

The BIOS setup/utility uses a key-based navigation system called hot keys. Most of the BIOS setup utility hot keys can be used at any time during the setup navigation process. These keys include <F1>, <F2>, <Enter>, <ESC>, <Arrow> keys, and so on.



【Note】 : Some of the navigation keys differ from one screen to another.

Hot Keys	Descriptions
→← Left/Right	The Left and Right <Arrow> keys allow users to select a setup screen.
↑↓ Up/Down	The Up and Down <Arrow> keys allow users to select a setup screen or sub-screen.
+– Plus/Minus	The Plus and Minus <Arrow> keys allow users to change the field value of a particular setup item.
Tab	The <Tab> key allows users to select setup fields.
F1	The <F1> key allows users to display the General Help screen.
F2	The <F2> key allows users to Load Previous Values.
F3	The <F3> key allows users to Load Optimized Defaults.
F4	The <F4> key allows users to save any changes they made and exit the Setup. Press the <F4> key to save any changes.
Esc	The <Esc> key allows users to discard any changes they made and exit the Setup. Press the <Esc> key to exit the setup without saving any changes.
Enter	The <Enter> key allows users to display or change the setup option listed for a particular setup item. The <Enter> key can also allow users to display the setup sub- screens.

4.3 Main Menu

The Main Menu screen is the first screen users see when entering the setup utility. Users can always return to the Main setup screen by selecting the Main tab. System Time/Date can be set up as described below. The Main BIOS setup screen is also shown below.

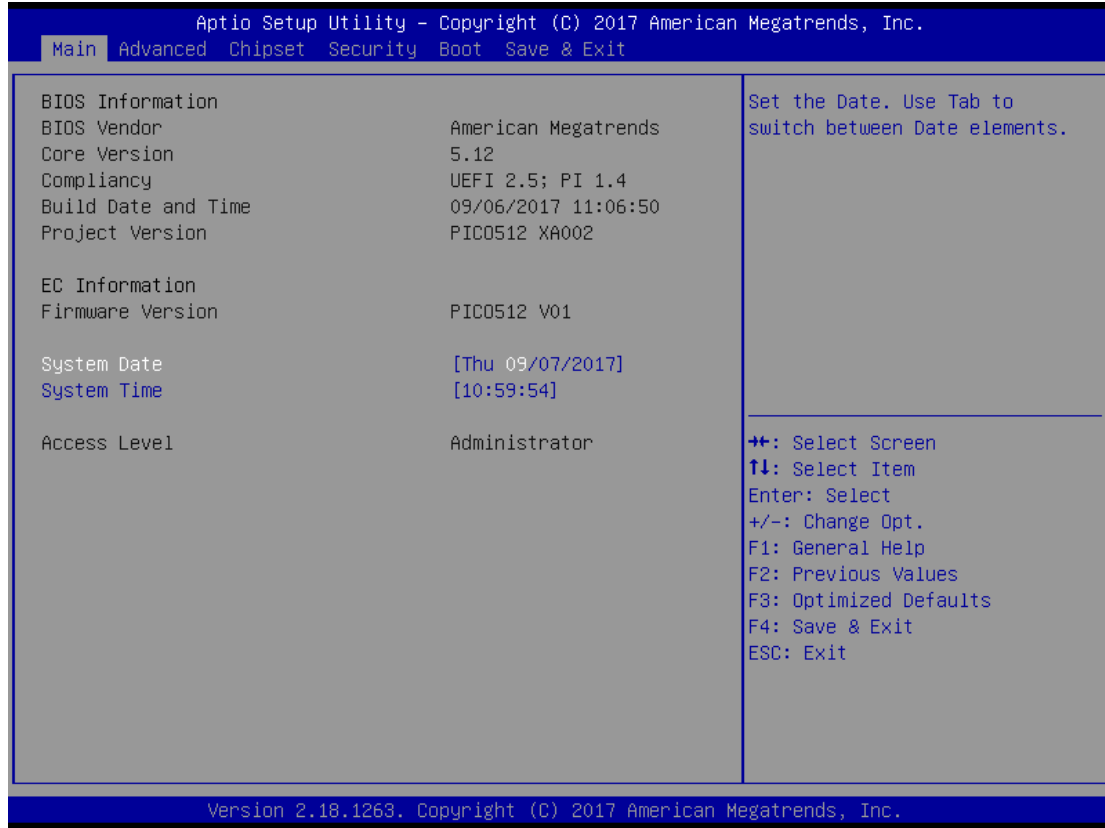

BIOS Information

Display the auto-detected BIOS information.

System Language

Choose the system default language.

System Date/Time

Use this option to change the system time and date. Highlight System Time or System Date using the <Arrow> keys. Enter new values through the keyboard. Press the <Tab> key or the <Arrow> keys to move between fields. The date must be entered in MM/DD/YY format. The time is entered in HH:MM:SS format.

Access Level

Display the access level of current user.

4.4 Advanced Menu

The Advanced menu also allows users to set configuration of the CPU and other system devices. Users can select any items in the left frame of the screen to go to sub menus:

- ▶ Hardware Monitor
- ▶ Utility Configuration
- ▶ ACPI Settings
- ▶ CPU Configuration
- ▶ SATA Configuration
- ▶ PCH-FW Configuration
- ▶ AMT Configuration
- ▶ USB Configuration
- ▶ Device Configuration

For items marked with “▶”, please press <Enter> for more options.



- **Utility Configuration**



BIOS Flash Utility

BIOS flash utility configuration. For more detailed information, please refer to Appendix B.

- **Hardware Monitor**

This screen monitors hardware health status.

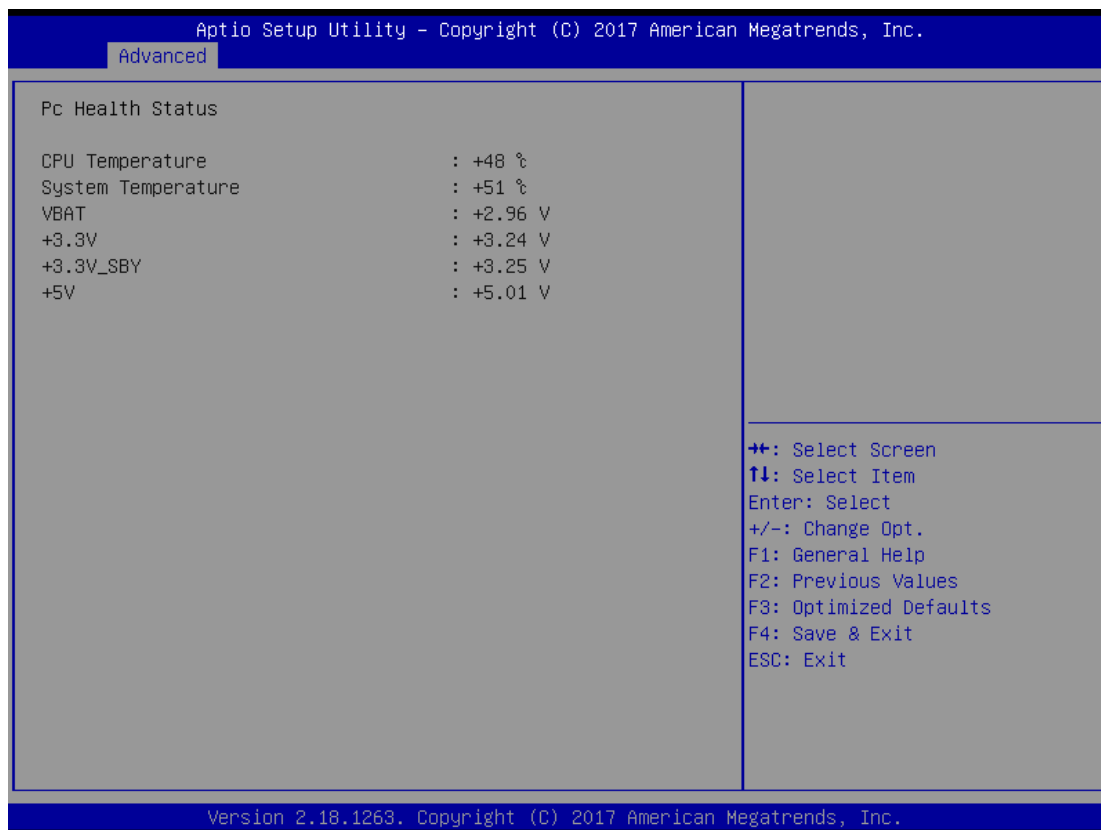

- **ACPI Settings**

Users can use this screen to select options for the ACPI configuration, and change the value of the selected option. A description of the selected item appears on the right side of the screen.

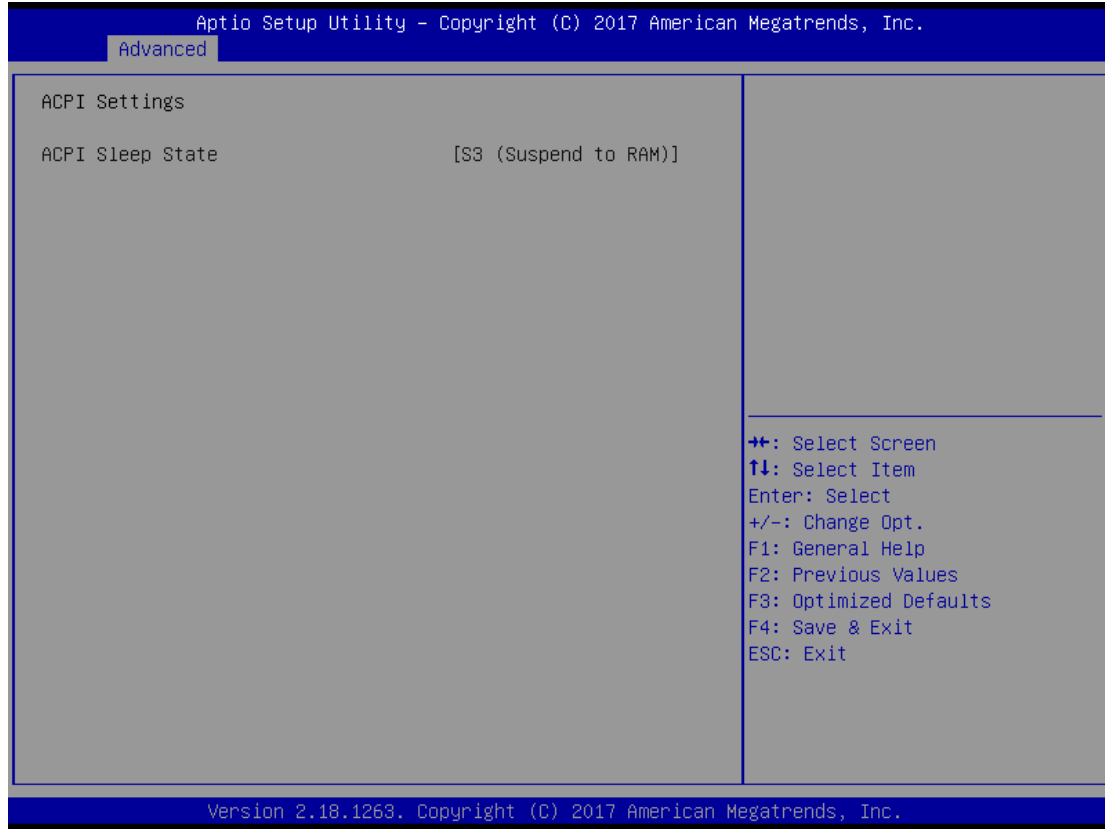

ACPI Sleep State

When the suspend button is pressed, the ACPI sleep state is S3 (Suspend to RAM).

- **CPU Configuration**

This screen shows the CPU information.



Intel Virtualization Technology

It allows a hardware platform to run multiple operating systems separately and simultaneously, enabling one system to virtually function as several systems.

SATA Configuration

In this Configuration menu, you can see the currently installed hardware in the SATA ports. During system boot up, the BIOS automatically detects the presence of SATA devices.

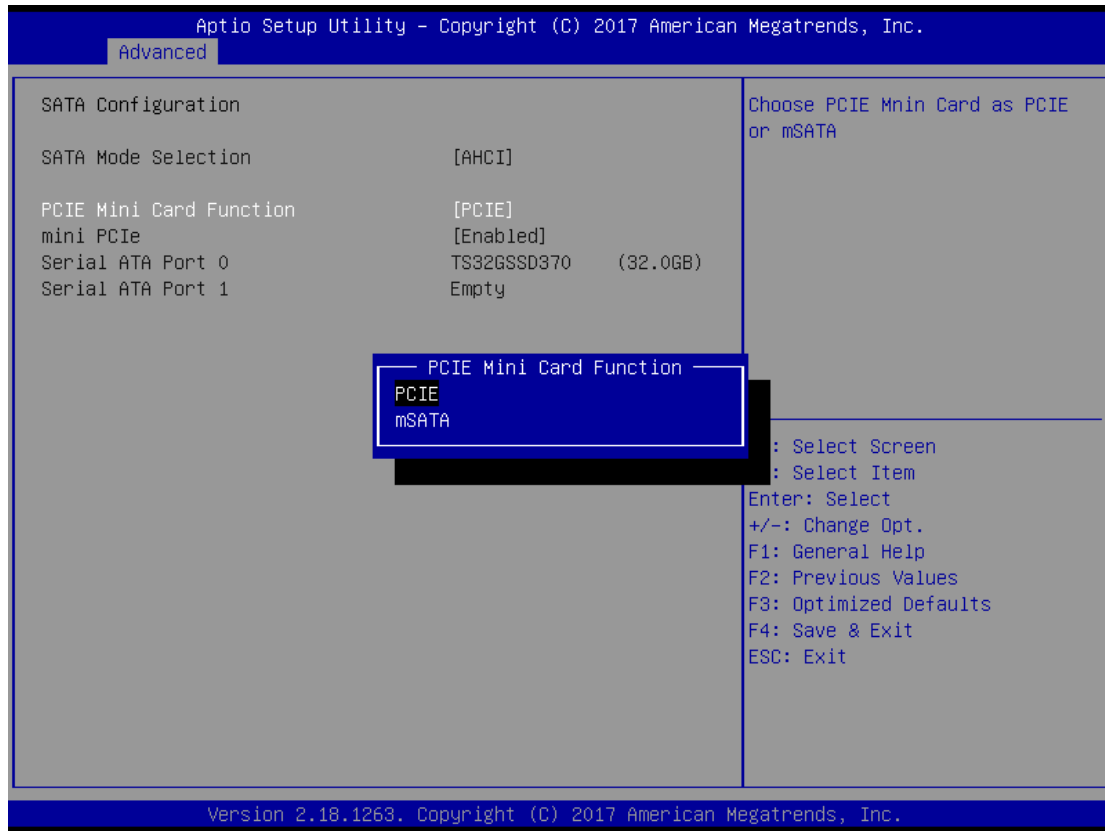

SATA Mode Selection

AHCI(Advanced Host Controller Interface)modeis how SATA controller(s)operate.

PCIE Mini Card Function

Select Mini PCIe or mSATA device. The default is PCIE.

mini PCIe

When mSATA is enabled, mini PCIe is disabled automatically and vice versa.

Serial ATA Port 0

It shows the device installed in connector CN4 (see section 2.5.2).

Serial ATA Port 1

It shows the installed mSATA card when mSATA is enabled..

- PCH-HW

This screen displays ME Firmware information.



- **AMT Configuration**

Use this screen to configure AMT parameters.

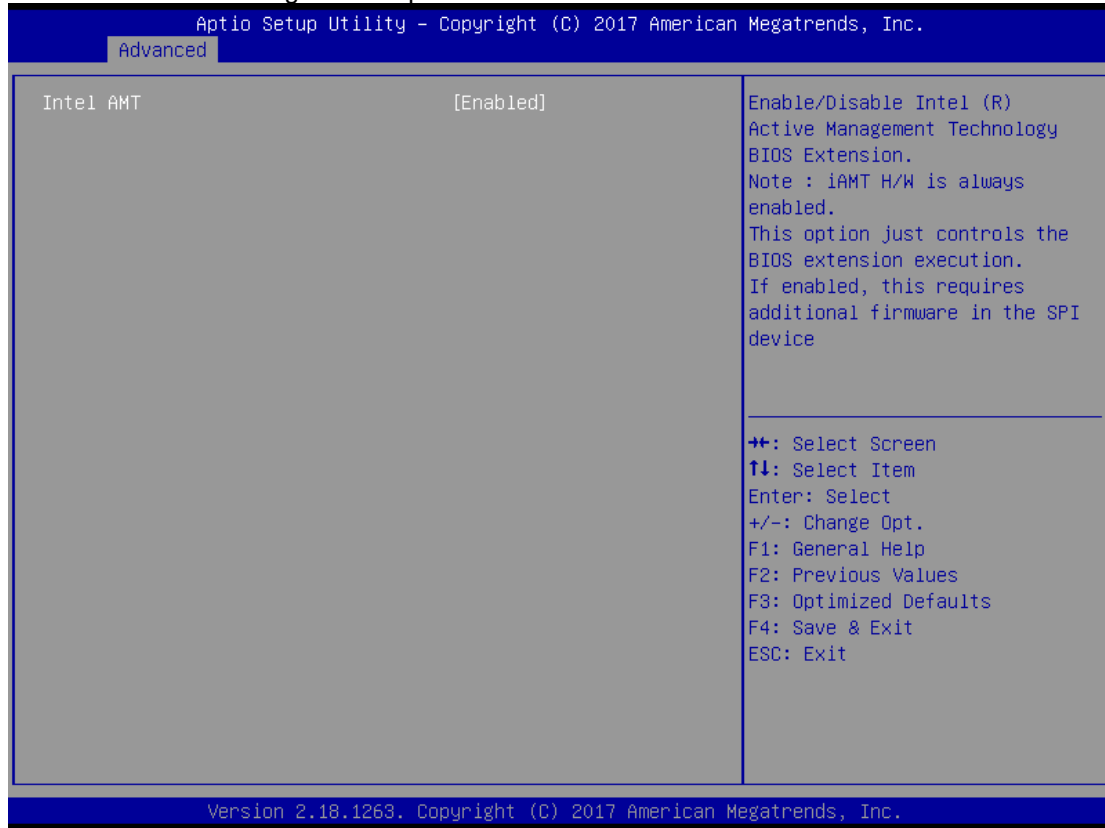

Intel AMT

Enable or disable Intel® Active Management Technology BIOS Extension. The default is Enabled. For more detailed information, please refer to Appendix C.

- **USB Configuration**

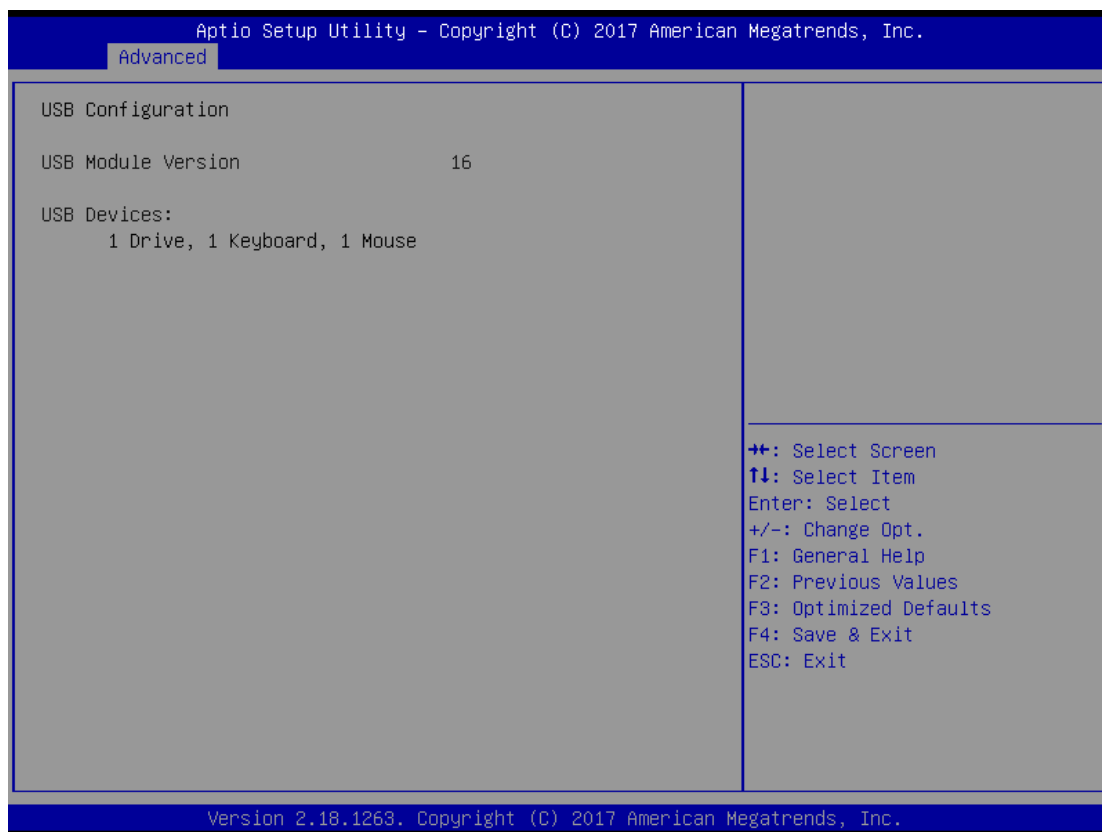
**USB Devices**

Display all detected USB devices.

- **Device Configuration**

A description of selected item appears on the right side of the screen. For items marked with “▶”, please press <Enter> for more options.

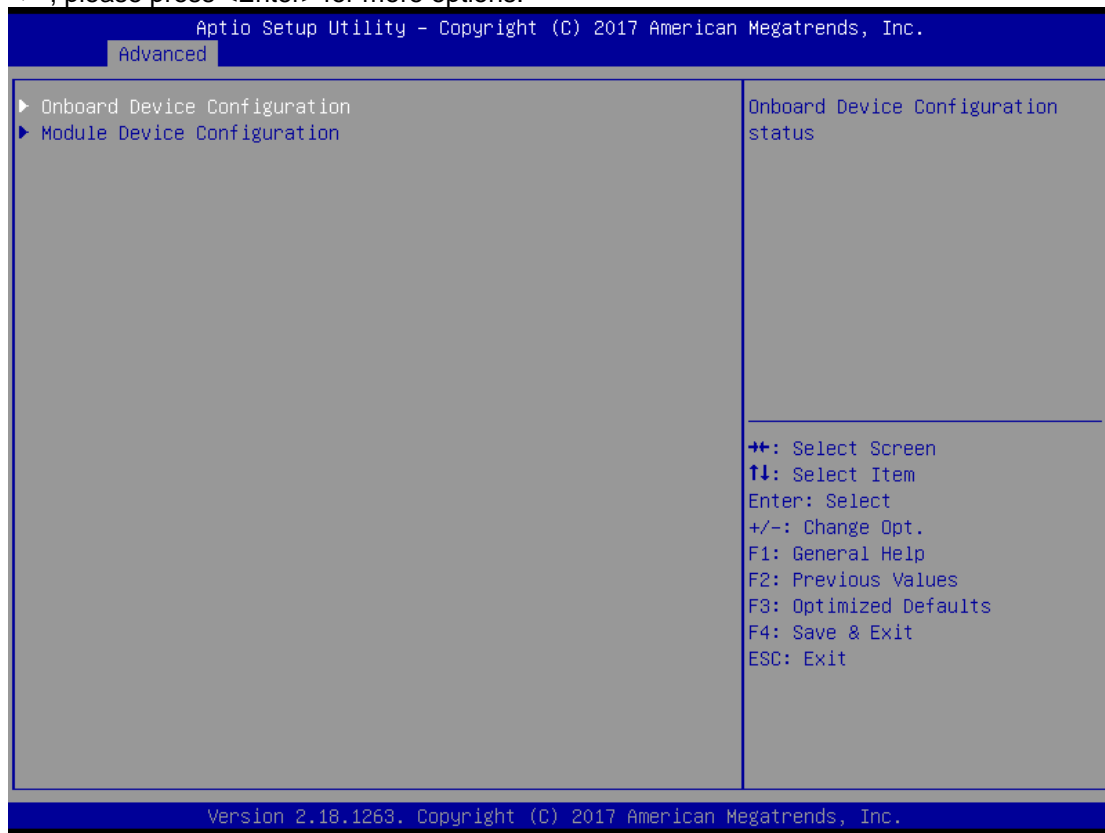

Onboard Device Configuration

Use this option to configure onboard device (e.g., Digital I/O setting).

Module Device Configuration

This option appears only if an I/O board is installed. BIOS will auto-detect all supported functions and you can use it to change settings on the I/O board. The eBOX560-512 supports AX93A01 IO board.

4.5 Chipset Menu

The Chipset menu allows users to change the advanced chipset settings. You can select any of the items in the left frame of the screen to go to the sub menus:

- ▶ PCH-IO Configuration
- ▶ System Agent (SA) Configuration

For items marked with “▶”, please press <Enter> for more options.

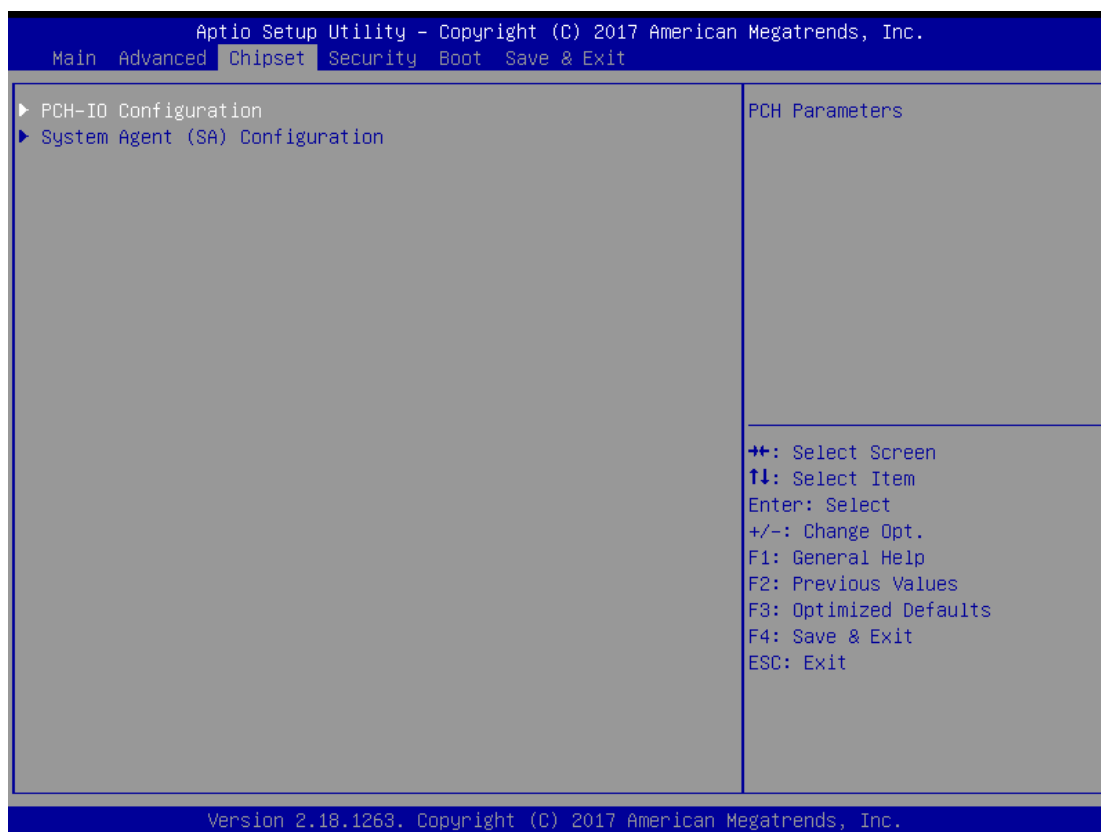

- **PCH-IO Configuration**

This screen allows you to set PCH parameters.



- **HD Audio Configuration**

Control detection of the HD Audio device. Configuration options are Disabled and Enabled.

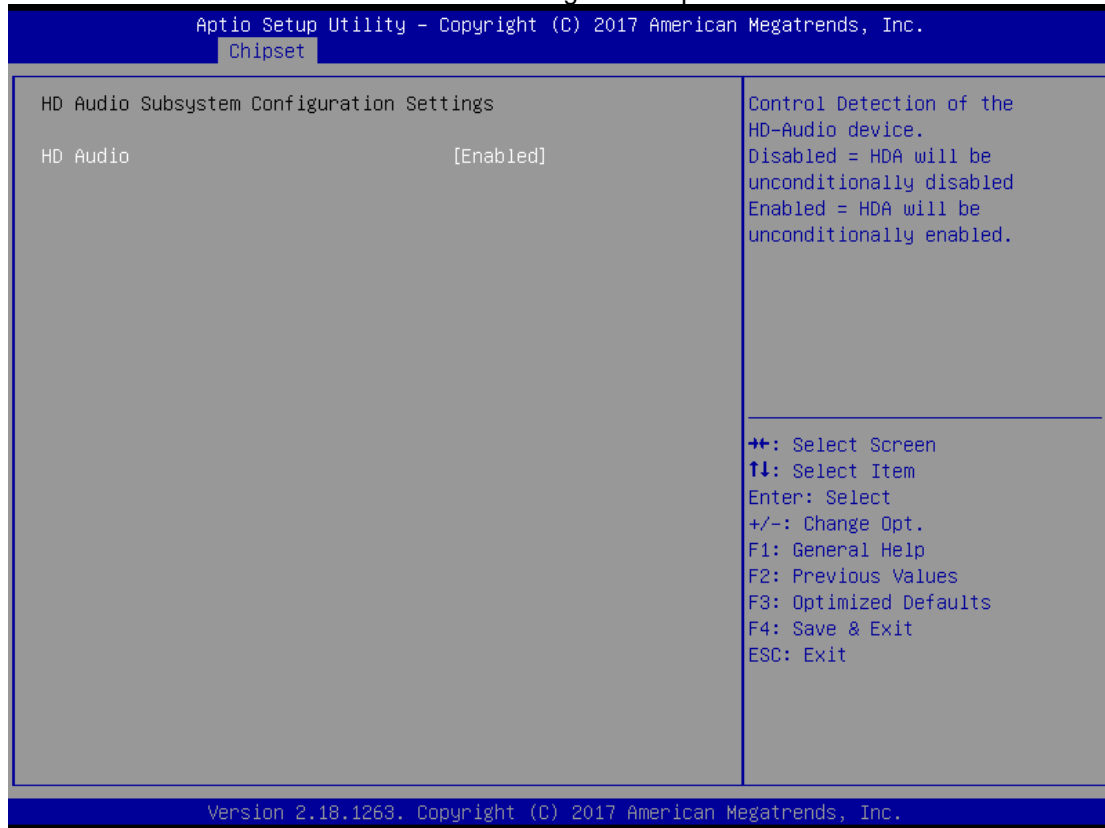

HD Audio

Use this item for HD Audio configuration settings.

- **System Agent (SA) Configuration**

This screen shows System Agent version information and provides function for specifying related parameters.

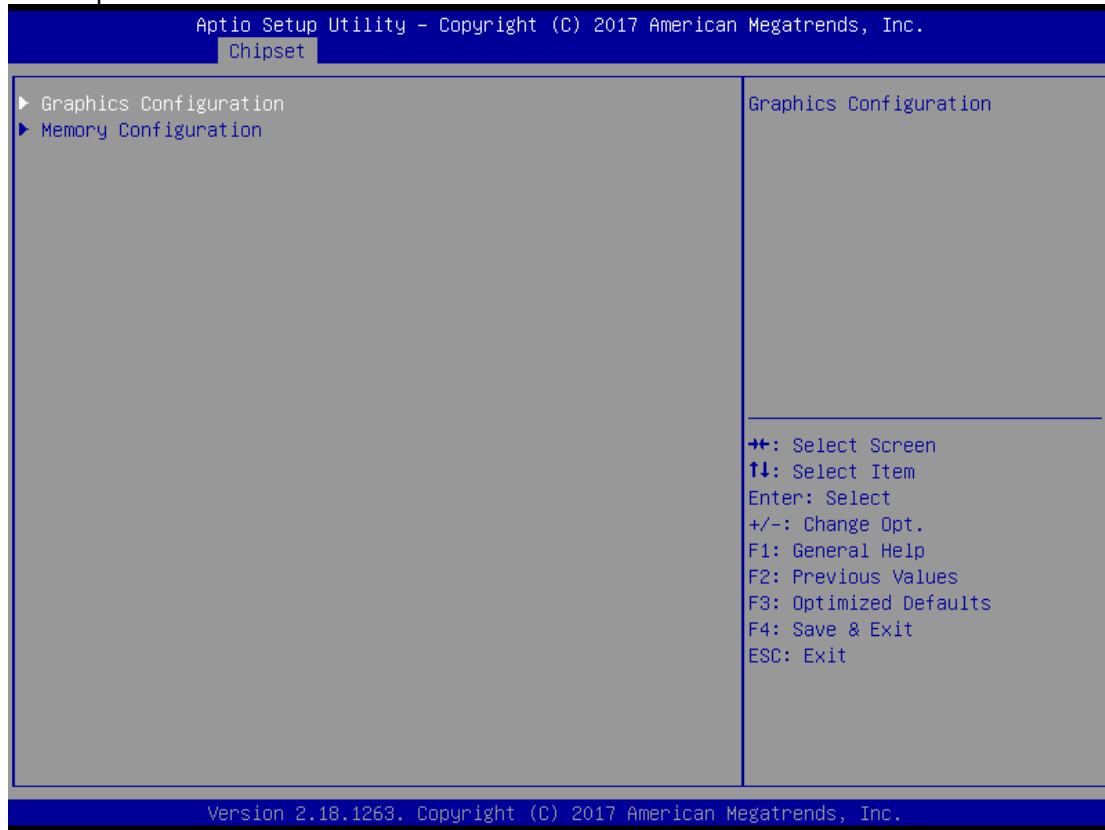

Graphics Configuration

Use this item to configure internal graphics controller.

Memory Configuration

Use this item to refer to the information related to system memory.

- **Graphics Configuration**

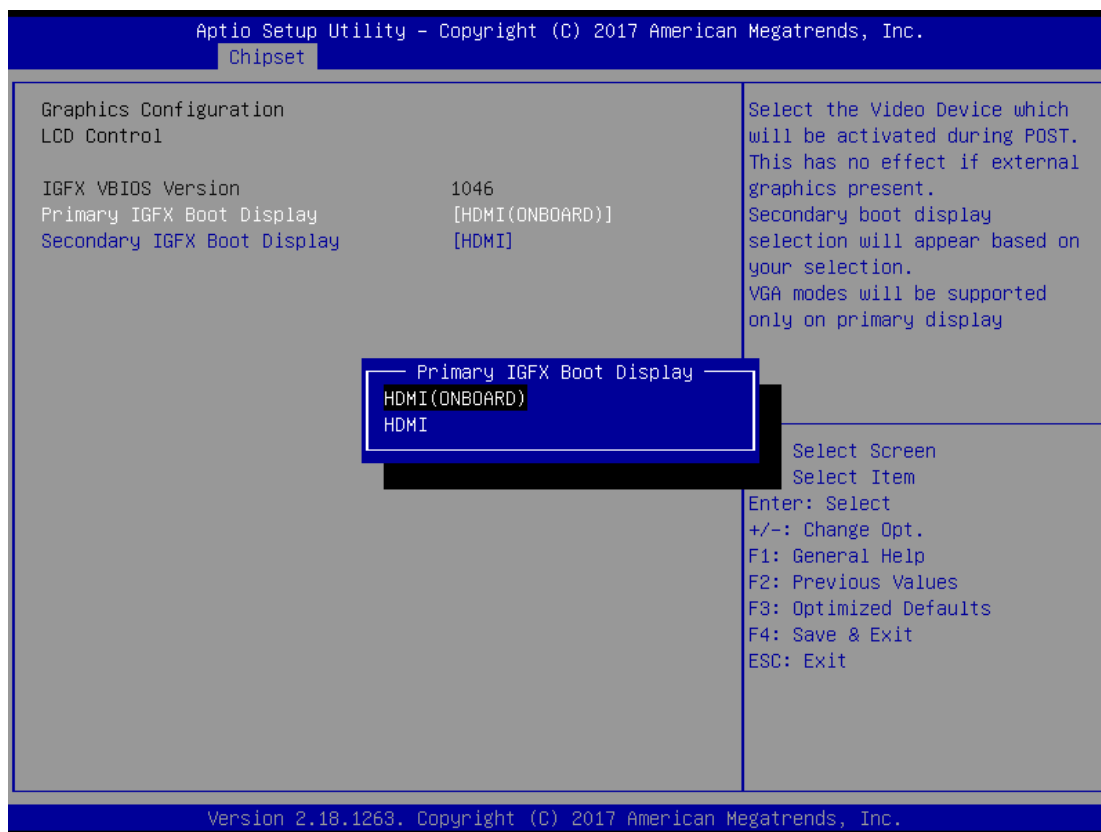

Primary IGFX Boot Display

Select the video device which will be activated during POST (Power-On Self Test). The default is HDMI(ONBOARD). The image above shows option list in Primary IGFX Boot Display when no I/O board is installed.



Note: When powering on eBOX560-512 for the first time, video device must be plugged into HDMI connector (PICO512-CN15). Then, after first power on, you can set HDMI on AX93276 as primary IGFX boot display.



HDMI connector (PICO512-CN15) on rear side

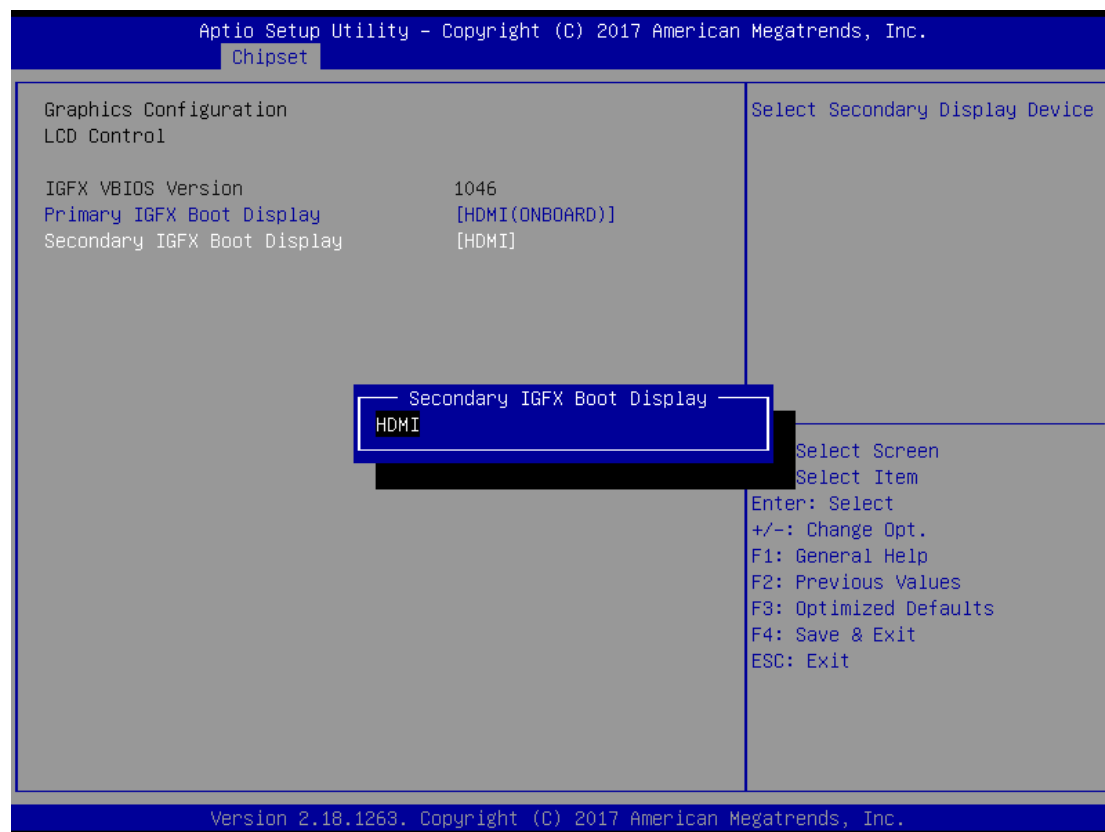

Secondary IGFX Boot Display

Select secondary display device. The default is Disabled.

- **Memory Information**

This screen shows the system memory information.



4.6 Security Menu

The Security menu allows users to change the security settings for the system.

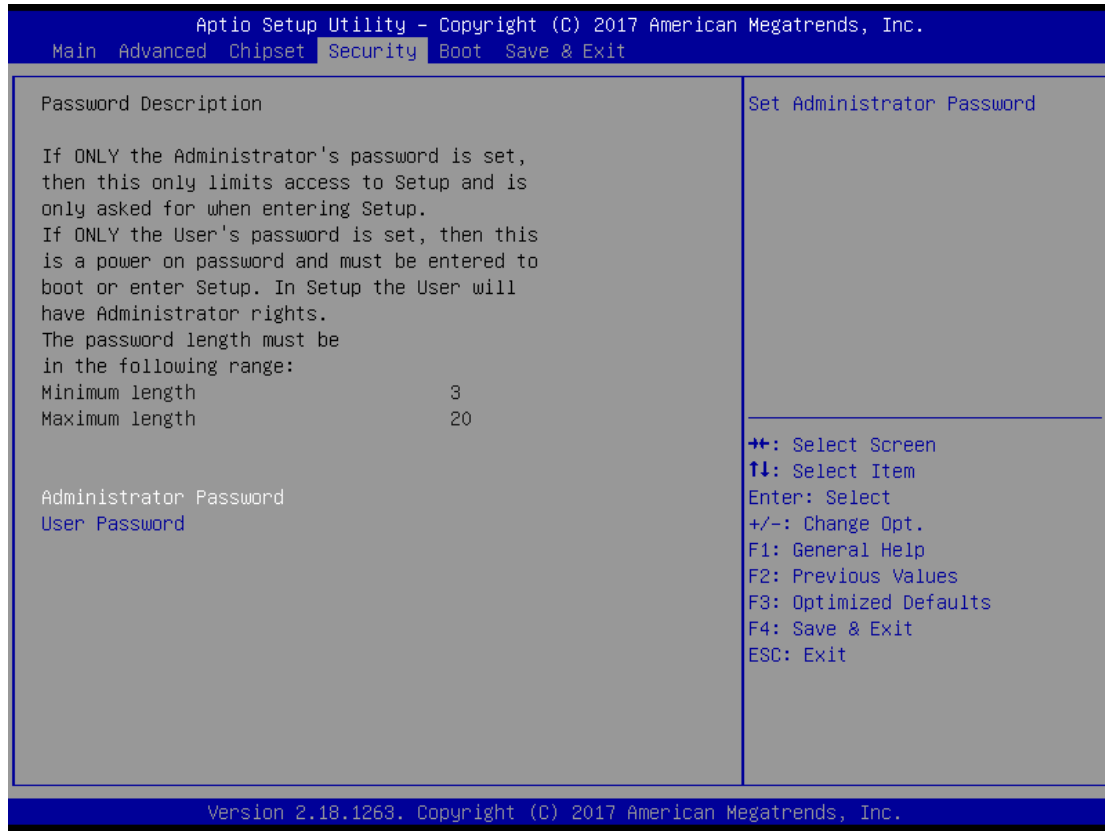

Administrator Password

This item indicates whether an administrator password has been set (installed or uninstalled).

User Password

This item indicates whether a user password has been set (installed or uninstalled).

4.7 Boot Menu

The Boot menu allows users to change boot options of the system.

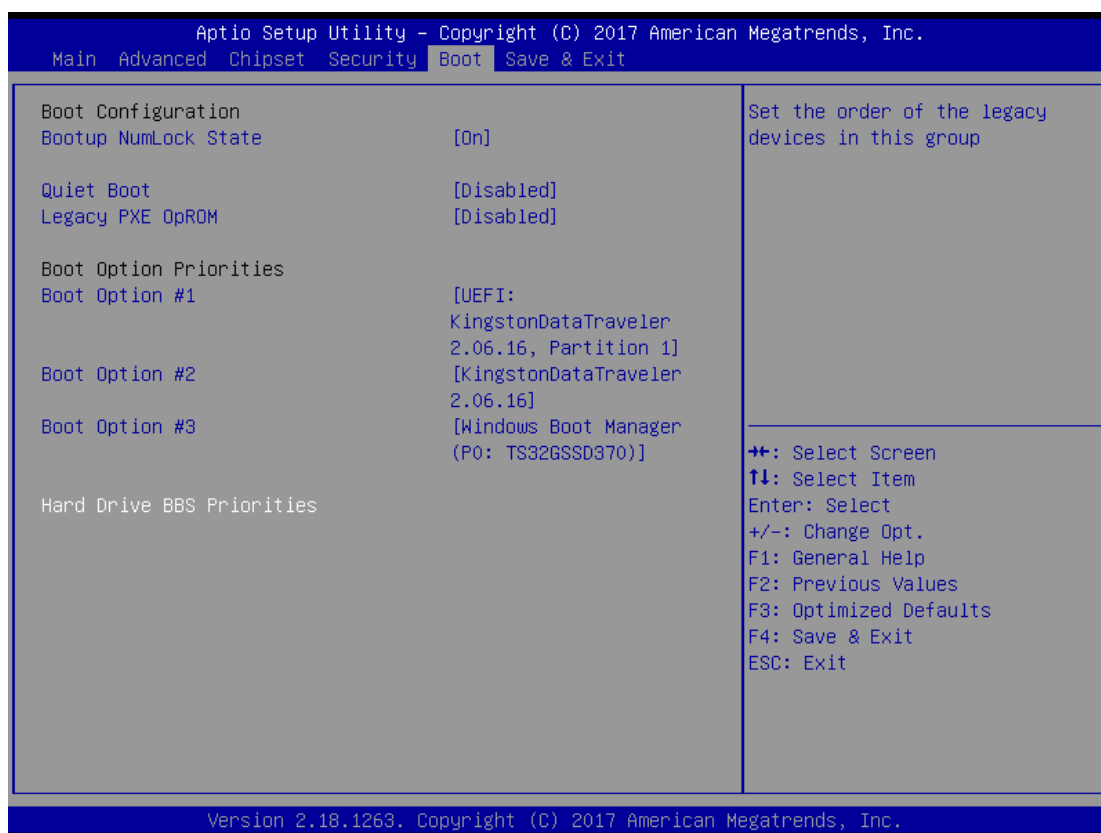

Bootup NumLock State

Use this item to select the power-on state for the keyboard NumLock.

Quiet Boot

Select to display either POST output messages or a splash screen during boot-up.

Legacy PXE OProm

Use this item to enable or disable the boot ROM function of the onboard LAN chip when the system boots up.

Boot Option Priorities

These are settings for boot priority. Specify the boot device priority sequence from the available devices.

4.8 Save & Exit Menu

The Save & Exit menu allows users to load system configurations with optimal or fail-safe default values.

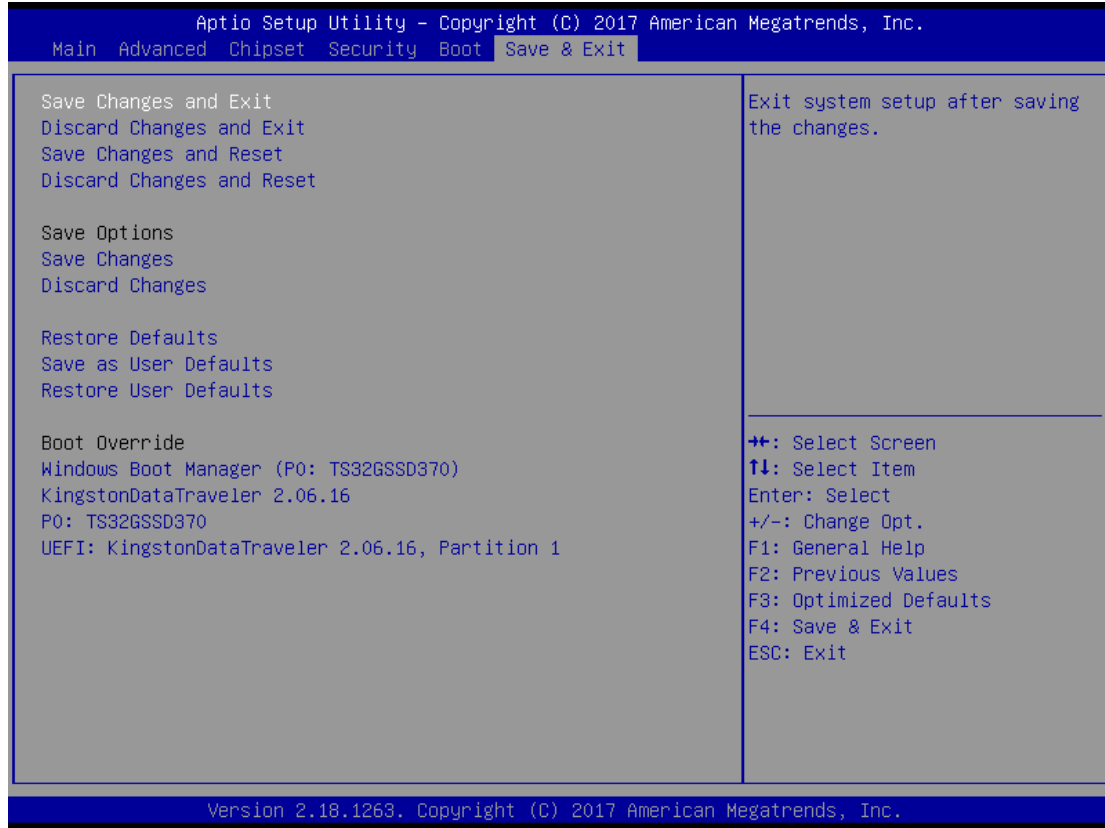

Save Changes and Exit

When users have completed the system configuration changes, select this option to leave Setup and return to Main Menu. Select Save Changes and Exit from the Save & Exit menu and press <Enter>. Select Yes to save changes and exit.

Discard Changes and Exit

Select this option to quit Setup without making any permanent changes to the system configurations and return to Main Menu. Select Discard Changes and Exit from the Save & Exit menu and press <Enter>. Select Yes to discard changes and exit.

Save Changes and Reset

When completed the system configuration changes, select this option to leave Setup and reboot the computer so the new system configurations take effect. Select Save Changes and Reset from the Save & Exit menu and press <Enter>. Select Yes to save changes and reset.

Discard Changes and Reset

Select this option to quit Setup without making any permanent changes to the system configuration and reboot the computer. Select Discard Changes and Reset from the Save & Exit menu and press <Enter>. Select Yes to discard changes and reset.

Save Changes

When completed the system configuration changes, select this option to save changes. Select Save Changes from the Save & Exit menu and press <Enter>. Select Yes to save changes.

Discard Changes

Select this option to quit Setup without making any permanent changes to the system configurations. Select Discard Changes from the Save & Exit menu and press <Enter>. Select Yes to discard changes.

Restore Defaults

It automatically sets all Setup options to a complete set of default settings when users select this option. Select Restore Defaults from the Save & Exit menu and press <Enter>.

Save as User Defaults

Select this option to save system configuration changes done so far as User Defaults. Select Save as User Defaults from the Save & Exit menu and press <Enter>.

Restore User Defaults

It automatically sets all Setup options to a complete set of User Defaults when users select this option. Select Restore User Defaults from the Save & Exit menu and press <Enter>.

Boot Override

Select a drive to immediately boot that device regardless of the current boot order.

This page is intentionally left blank.

APPENDIX A WATCHDOG TIMER

About Watchdog Timer

After the system stops working for a while, it can be auto-reset by the watchdog timer. The integrated watchdog timer can be set up in the system reset mode by program.

How to Use Watchdog Timer

Sample Program

Assembly sample code:

```
mov    dx,fa10          ; 5 seconds (Maximum is 65535 seconds; fill in
                        ; 0xFA10 and 0xFA11 register, ex: 0xFA11=0x01,
                        ; 0xFA10=0x68 means 360 seconds)

mov    al,05
out    dx,al

mov    dx,fa12          ; Enable WDT
mov    al,01
out    dx,al
```

This page is intentionally left blank.

APPENDIX B BIOS Flash Utility

The BIOS Flash utility is a new helpful function in BIOS setup program. With this function you can easily update system BIOS without having to enter operating system. In this appendix you may learn how to do it in just a few steps. Please read and follow the instructions below carefully.

1. In your USB flash drive, create a new folder and name it "Axiomtek", see figure below.

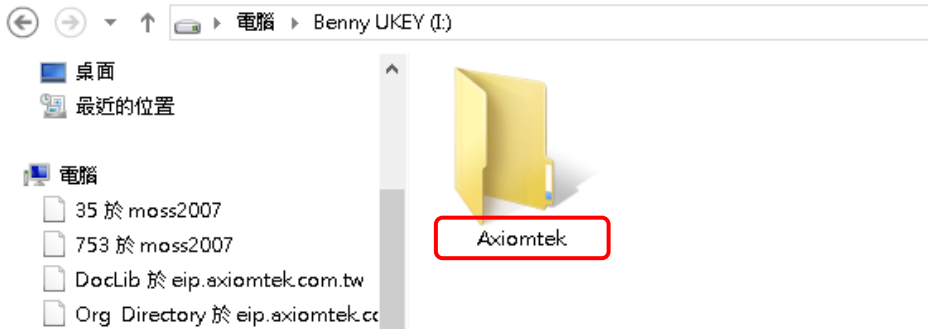

2. Copy BIOS ROM file (e.g. PICO512.005) to "Axiomtek" folder.



3. Insert the USB flash drive to your system.
4. Enter BIOS setup menu and go to Advanced\Utility Configuration. Select BIOS Flash Utility and press <Enter>.

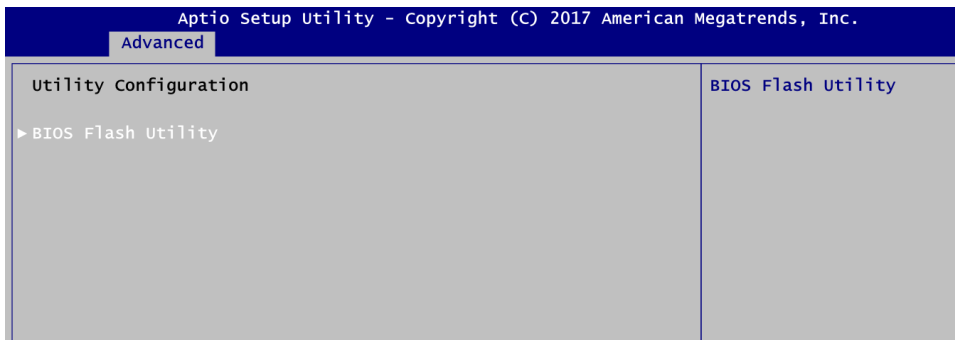

5. BIOS automatically detect all USB drive(s) attached to the system. In this example only one USB drive is attached to the system. That's why, you can see only one device is displayed in figure below.

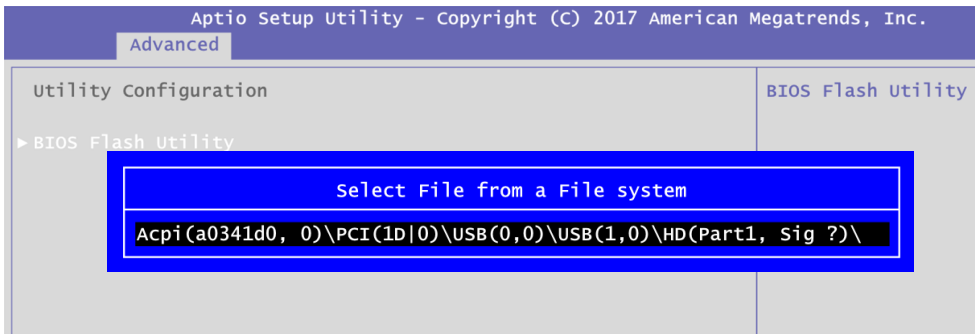

6. Select the USB drive containing BIOS ROM file you want to update using the <↑> or <↓> key. Then press <Enter> to get into "Axiomtek" folder.

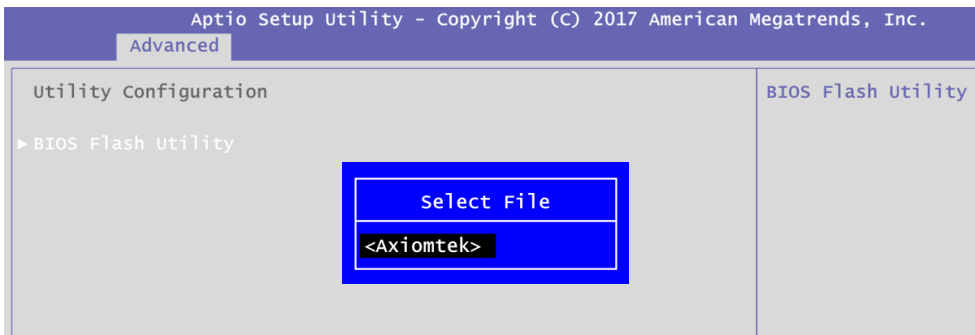

7. Now you can see the BIOS ROM file on the screen, press <Enter> to select.

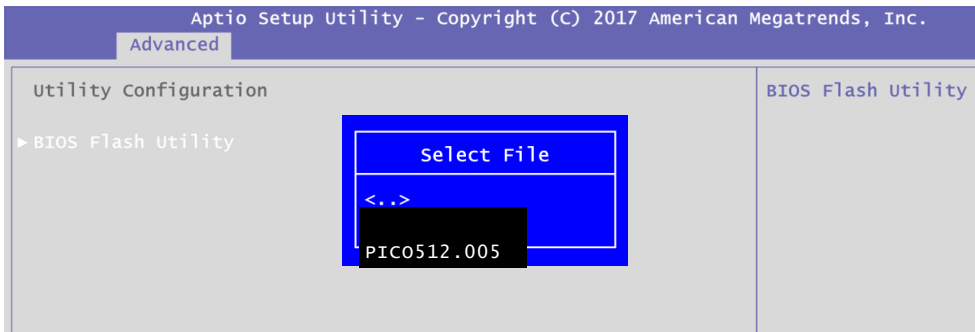

8. Select Start to flash system BIOS option to begin updating procedure.

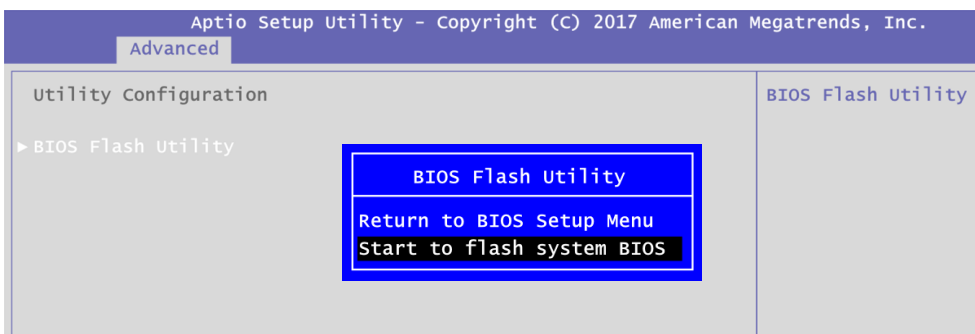

9. Please wait while BIOS completes the entire flash update process: erase data, write new data and verify data.

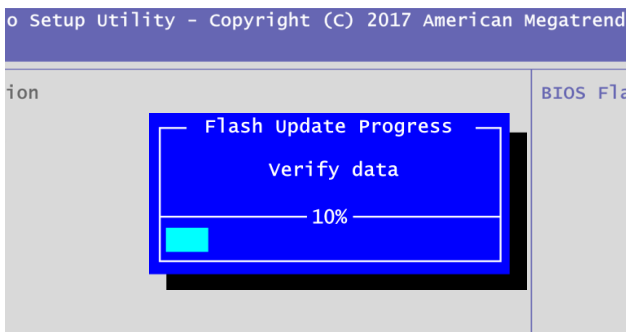
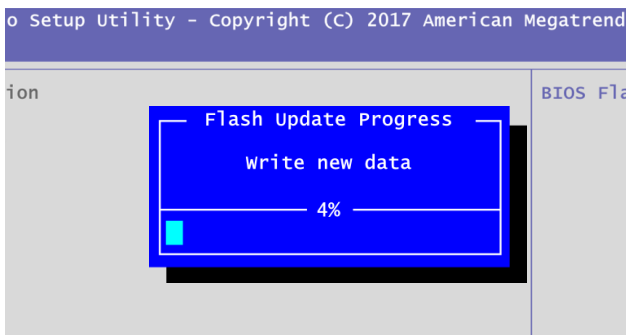
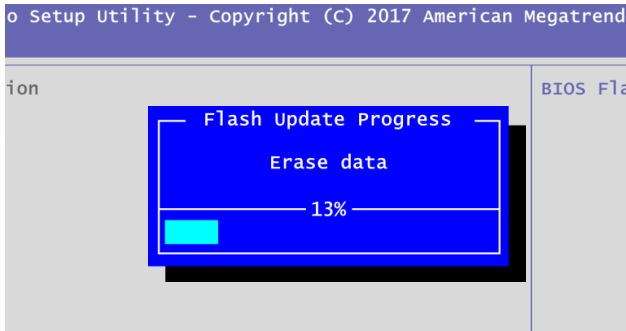

10. When you see the following figure, press <Enter> to finish the update process. After that the system will shut down and restart immediately.

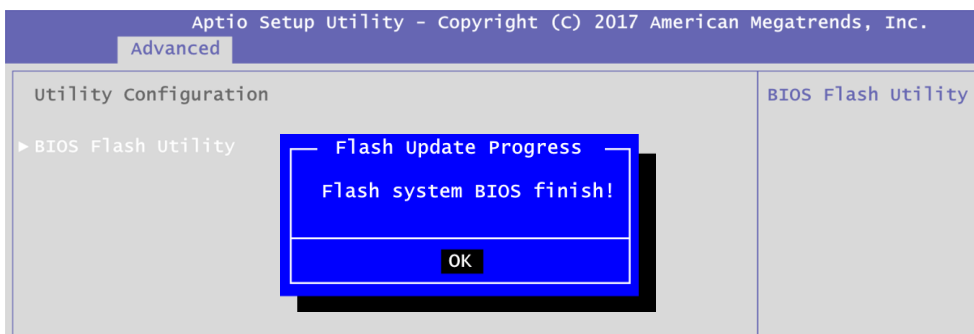

This page is intentionally left blank.

APPENDIX C

iAMT Settings

The Intel® Active Management Technology (Intel® iAMT) has decreased a major barrier to IT efficiency that uses built-in platform capabilities and popular third-party management and security applications to allow IT a better discovering, healing, and protection their networked computing assets.

In order to utilize Intel® iAMT you must enter the ME BIOS (<Ctrl + P> during system startup), change the ME BIOS password, and then select “Intel® iAMT” as the manageability feature.

C.1 Entering MEBx

1. Go to BIOS to enable iAMT function (see section 4.4).
2. Exit from BIOS after starting iAMT, and press <Ctrl + P> to enter MEBx Setting.



It is better to press <Ctrl + P> before the screen popping out.

Note

C.2 Set and Change Password

1. You will be asked to set a password when first log in. The default password is “admin”.

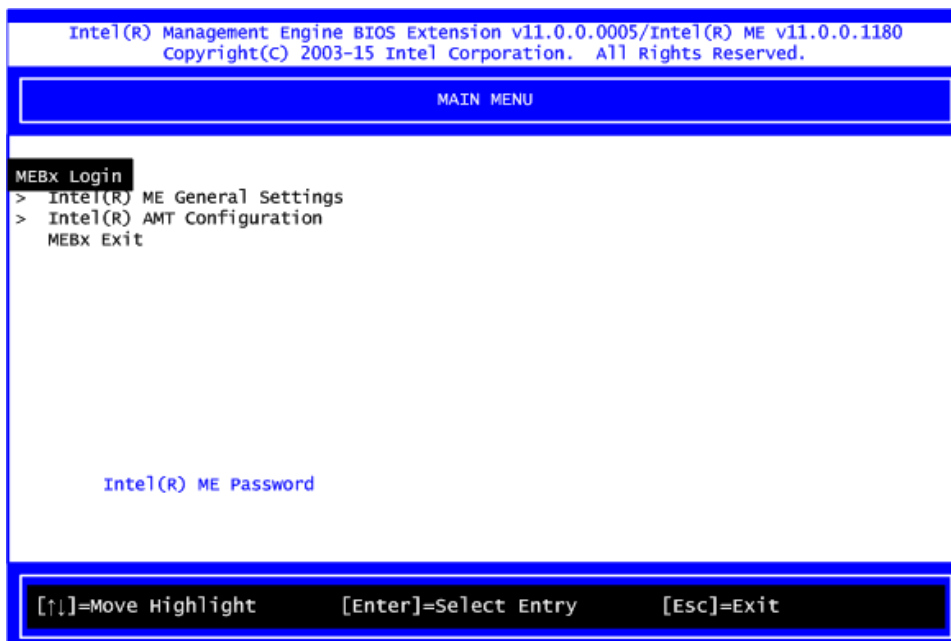

2. You will be asked to change the password before setting ME.

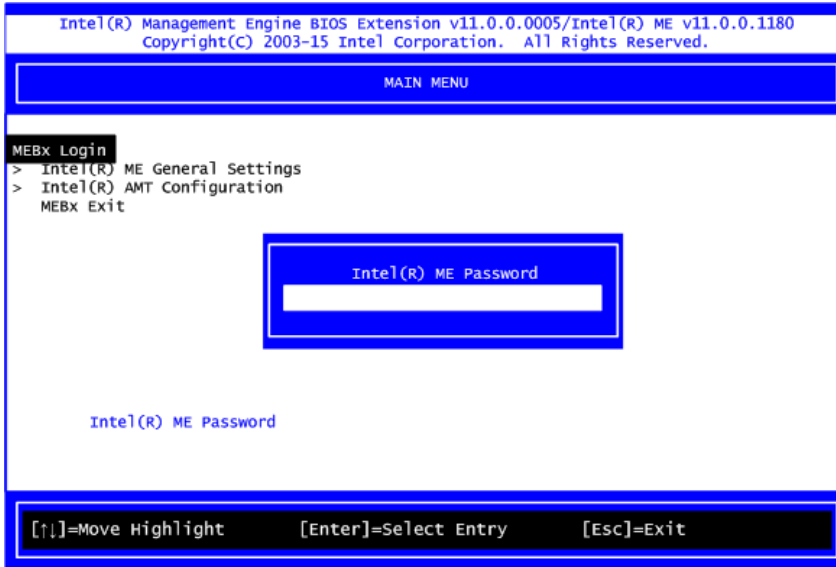

3. You must confirm your new password while revising. The new password must contain:
(example: **!!11qqQQ**) (default value).
- Eight characters
 - One upper case
 - One lower case
 - One number
 - One special symbol, such as ! \ \$ or ; , (\ " , , excepted)

Underline (_) and space are valid characters for password, but they won't make higher complexity.

4. From Main Menu, select ME General Settings to get into ME Platform Configuration screen. In this screen you can modify Local FW Update setting.

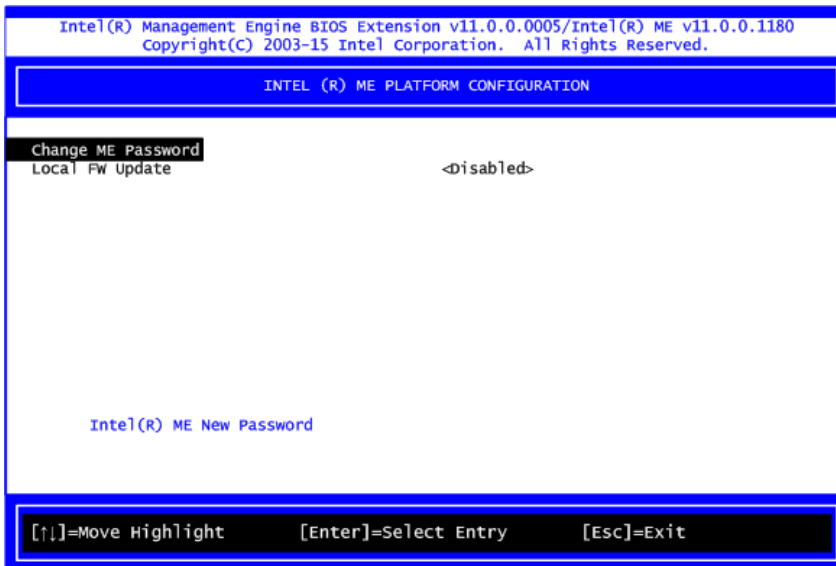

5. Return to Main Menu.

C.3 iAMT Settings

Select Intel® AMT configuration and press <Enter>.

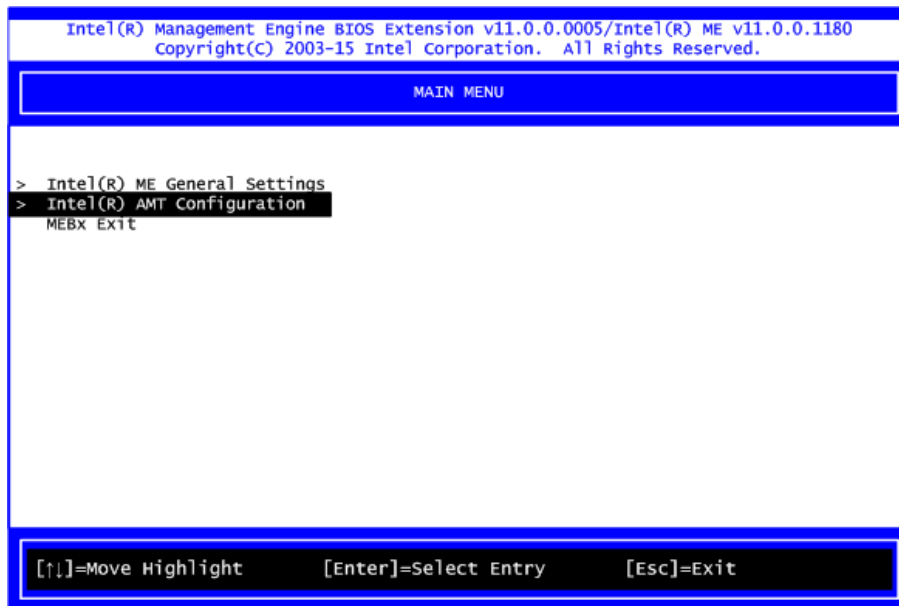

From AMT Configuration menu, select Manageability Feature Selection and set it to Enabled. This item allows you to enable or disable Intel® AMT feature.

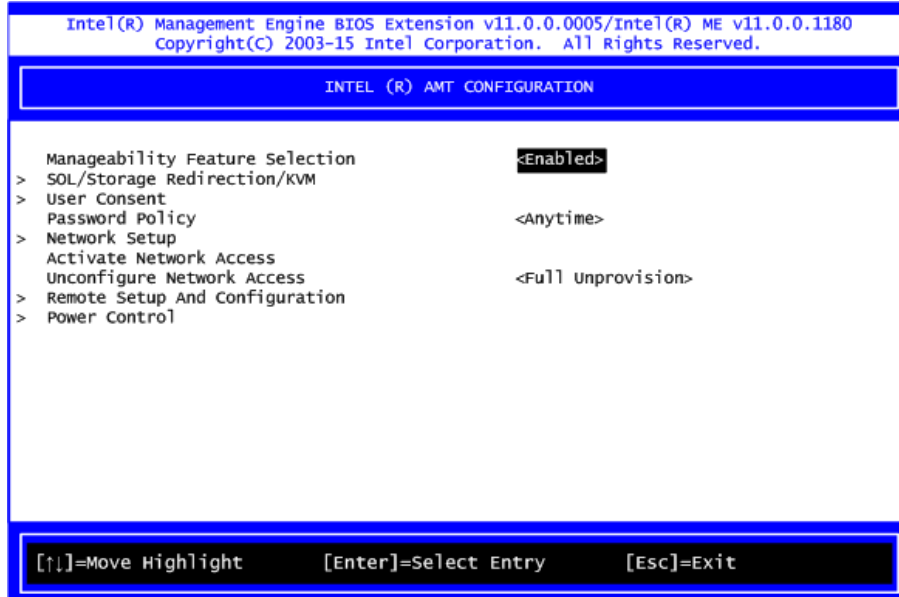

- **Network Setup**

1. Select Network Setup to configure iAMT.

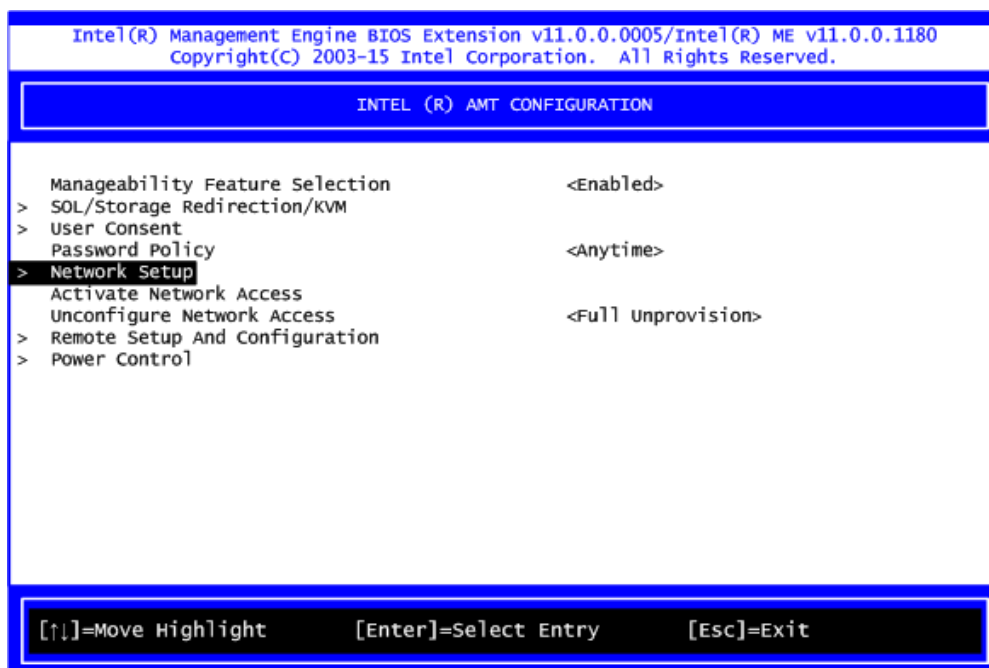

2. Select ME Network Name Settings to set computer host and domain name.

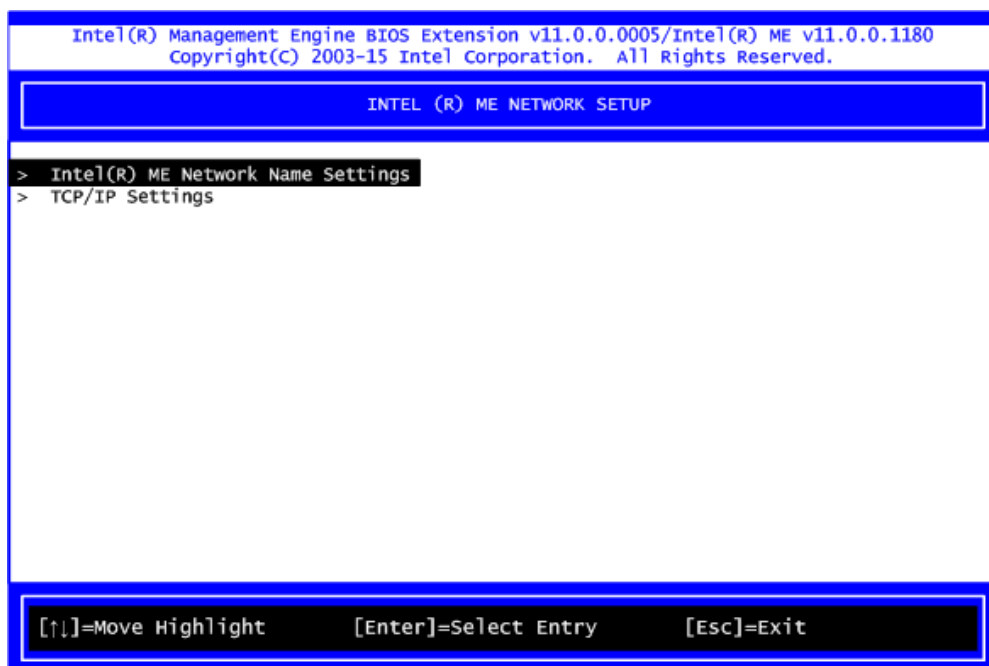

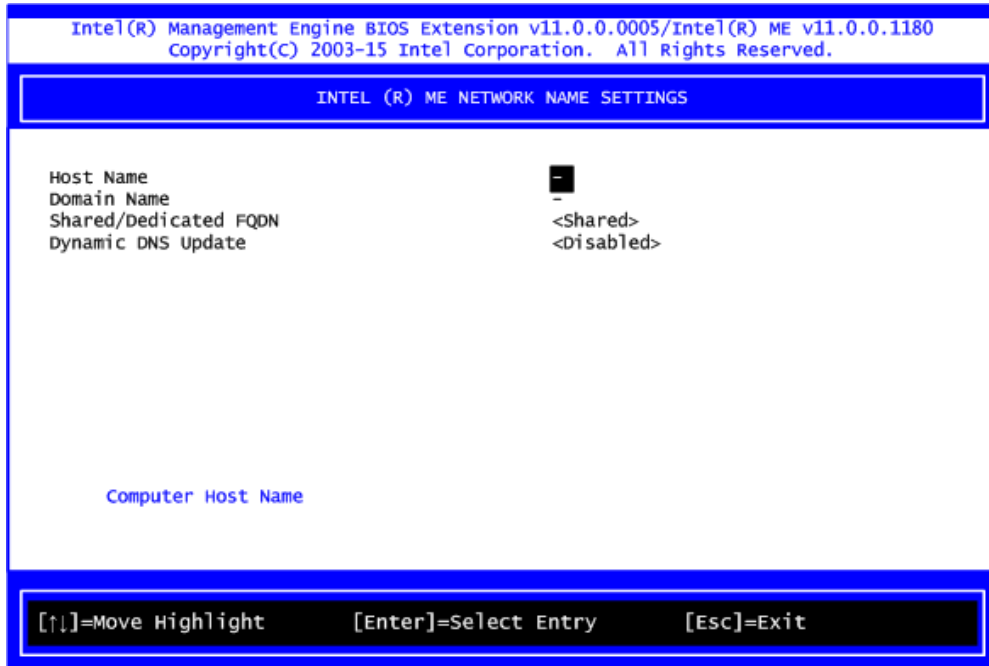

3. Select TCP/IP to get into Network interface and set it to Enabled. Get into DHCP Mode and set it to Disabled.

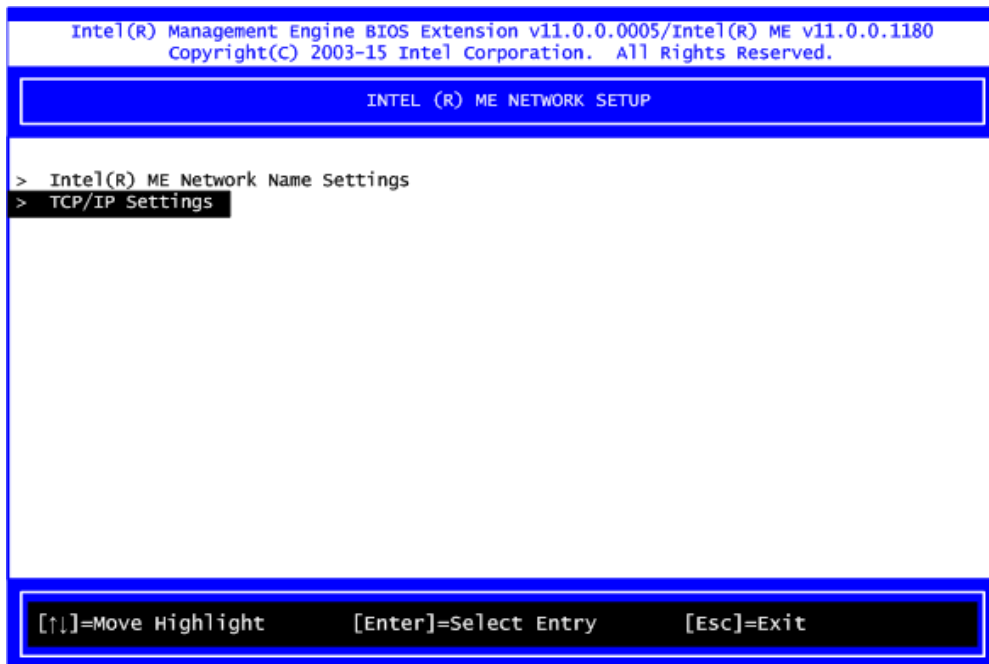

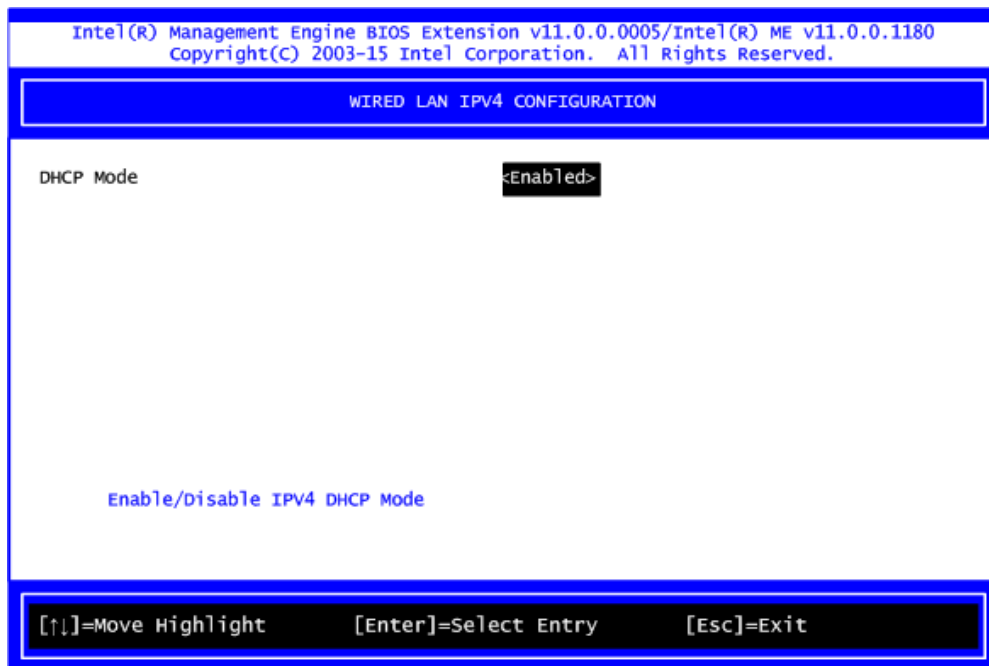
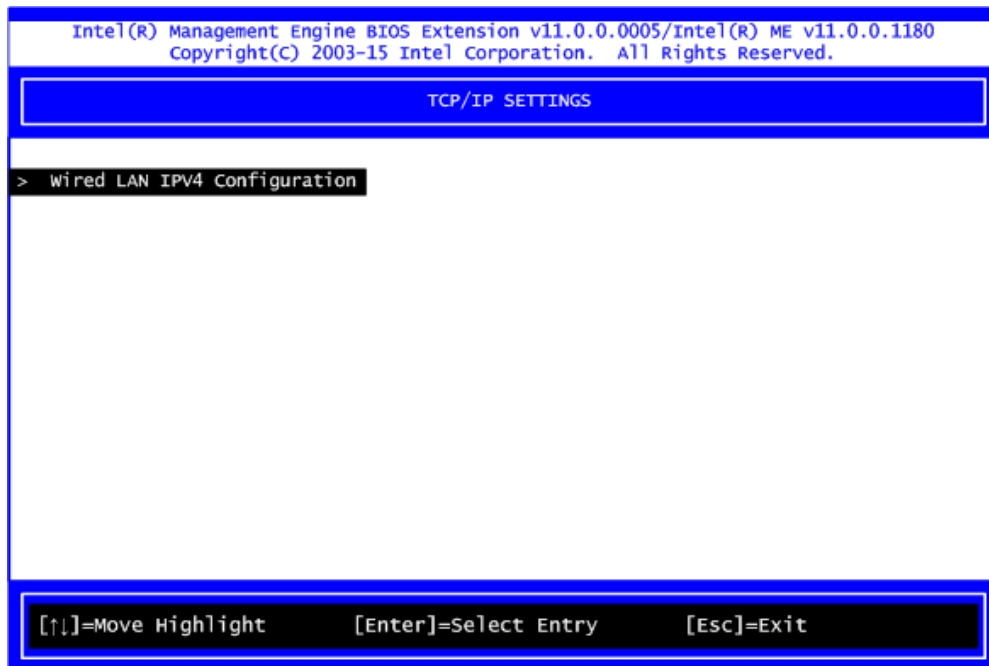

4. If DHCP Mode is disabled, set the following settings:

- IP address
- Subnet mask

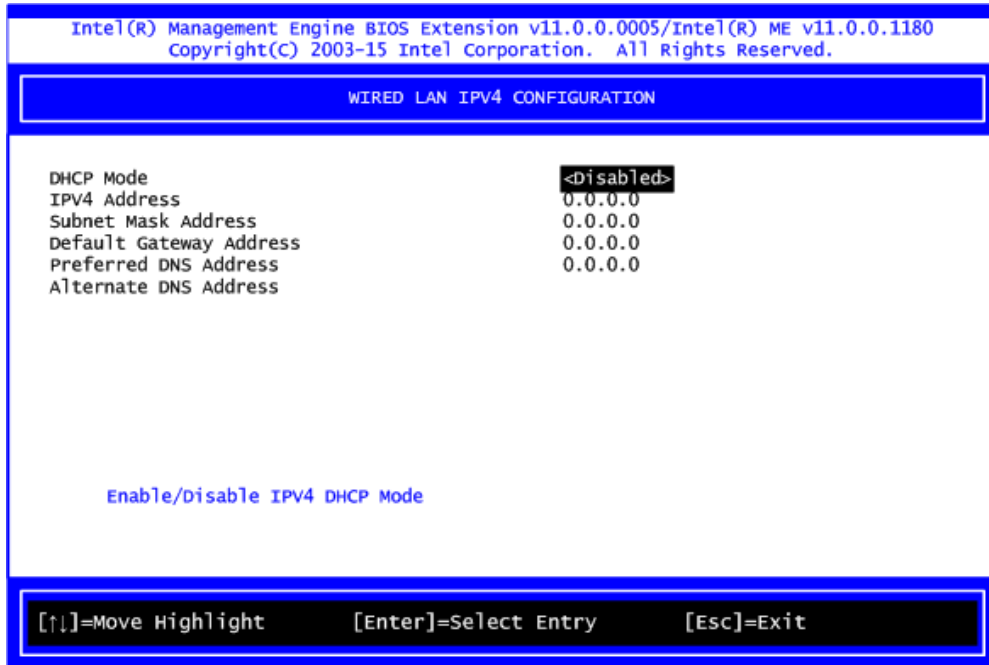

5. Go back to Intel® iAMT Configuration, then select Activate Network Access and press <Enter>.

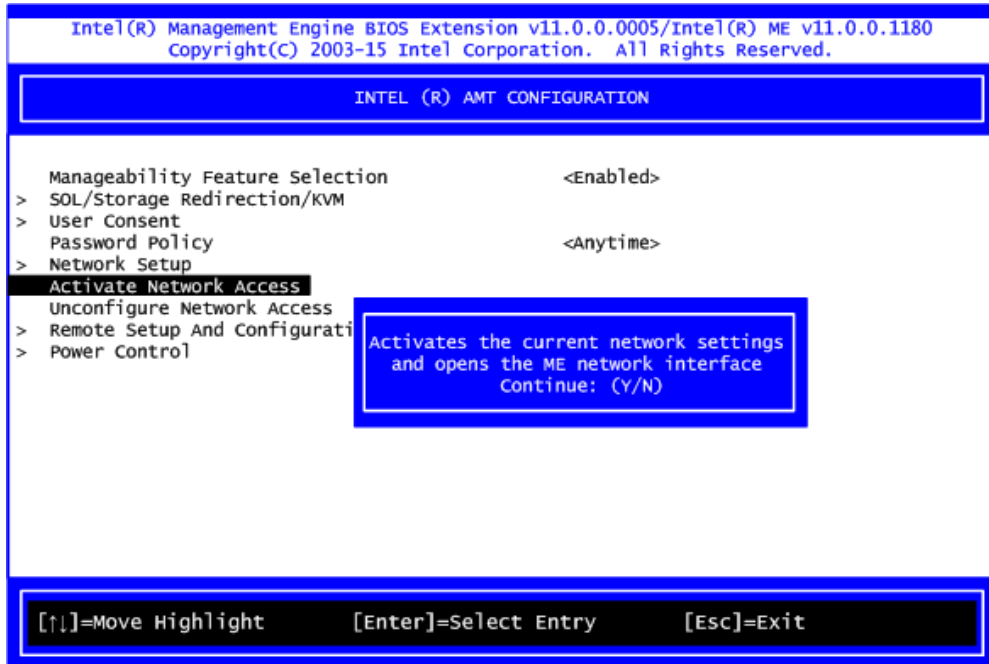

6. Exit from MEBx after completing the iAMT settings.

C.4 iAMT Web Console

1. From a web browser, please type [http://\(IP ADDRESS\):16992](http://(IP ADDRESS):16992), which connects to iAMT Web.

Example: <http://10.1.40.214:16992>

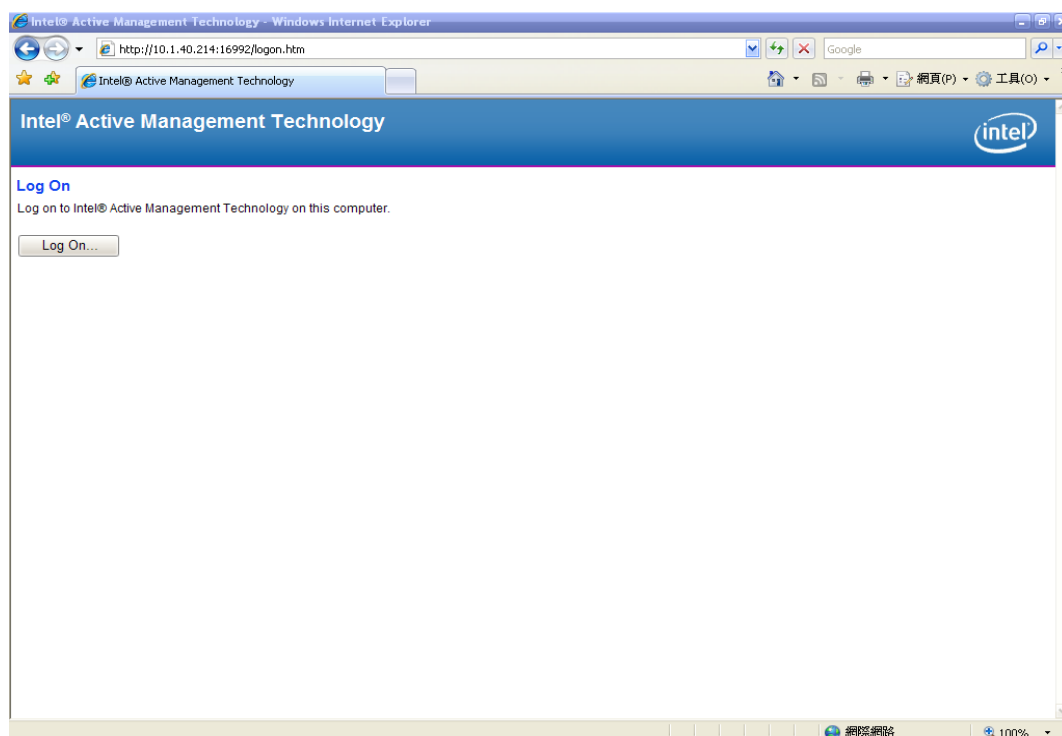

2. To log on, you will be required to type in username and password for access to the Web.
USER: admin (default value)
PASS: (MEBx password)

3. Enter the iAMT Web.

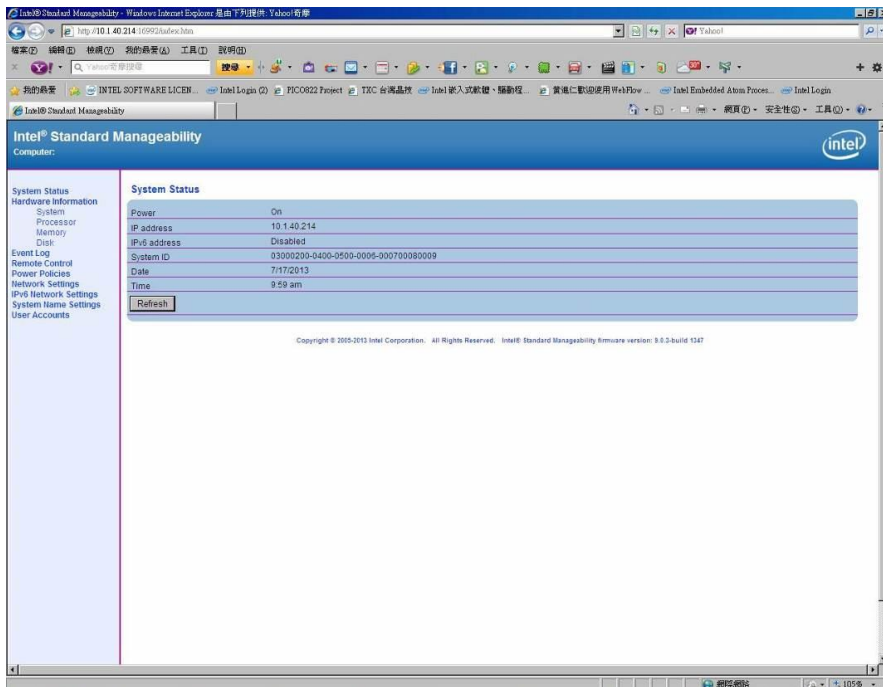

4. Click Remote Control, and select commands on the right side.

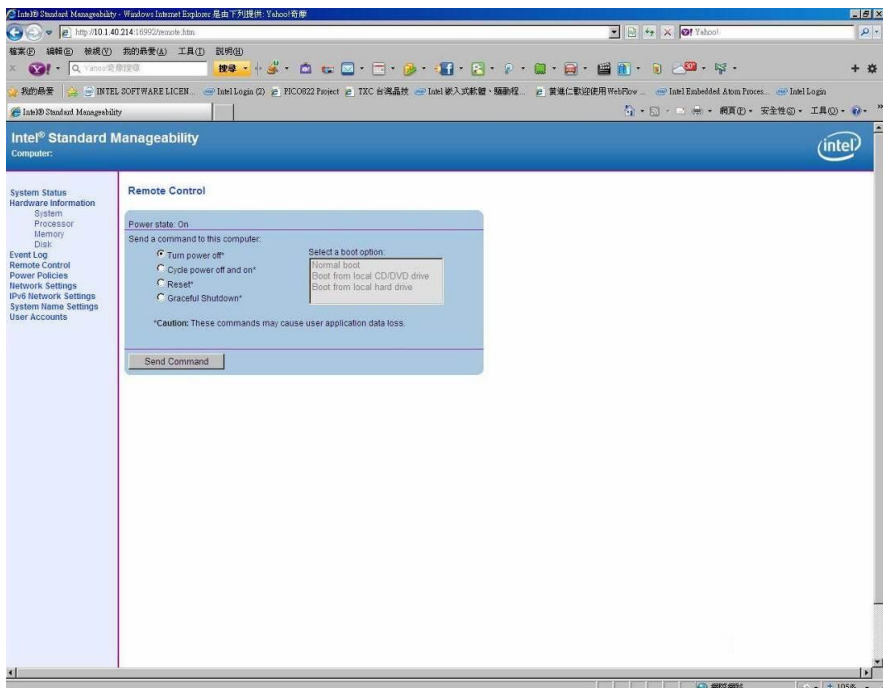

5. When you have finished using the iAMT Web console, close the Web browser.

This page is intentionally left blank.