



®

AXIOMTEK

eBOX100-312-FL Series

Embedded System

User's Manual



Disclaimers

This manual has been carefully checked and believed to contain accurate information. Axiomtek Co., Ltd. assumes no responsibility for any infringements of patents or any third party's rights, or any liability arising from such uses.

Axiomtek does not warrant or assume any legal liability or responsibility for the accuracy, completeness or usefulness of any information in this document. Axiomtek does not make any commitment to update any information in this manual.

Axiomtek reserves the right to change or revise this document and/or product at any time without notice.

No part of this document may be reproduced, stored in a retrieval system, or transmitted in any forms or by any means, electronic, mechanical, photocopying, recording, among others, without prior written permissions of Axiomtek Co., Ltd.

©Copyright 2019 Axiomtek Co., Ltd.

All Rights Reserved

Dec 2019, Version A4

Printed in Taiwan

Safety Precautions

Before getting started, please read the following important safety precautions.

1. The eBOX100-312-FL does not come with an operating system which must be loaded first before installation of any software into the computer.
2. Be sure to ground yourself to prevent static charge when installing any internal components. Use a wrist grounding strap and place all electronic components in any static-shielded devices. Most electronic components are sensitive to static electrical charge.
3. Disconnect the power cord from the eBOX100-312-FL prior to making any installation. Be sure both the system and all external devices are turned OFF. Sudden surge of power could ruin sensitive components. Make sure the eBOX100-312-FL is properly grounded.
4. Make sure the voltage of the power source is correct before connecting it to any power outlet.
5. Turn Off system power before cleaning. Clean the system using a cloth only. Do not spray any liquid cleaner directly onto the screen.
6. Do not leave equipment in an uncontrolled environment where the storage temperature is below -40°C or above 80°C as it may damage the equipment.
7. Do not open the system's back cover. If opening the cover for maintenance is a must, only a trained technician is allowed to do so. Integrated circuits on computer boards are sensitive to static electricity. To avoid damaging chips from electrostatic discharge, observe the following precautions:
 - Before handling a board or integrated circuit, touch an unpainted portion of the system unit chassis for a few seconds. This will help discharge any static electricity on human body.
 - When handling boards and components, wear a wrist grounding strap available from most electronic component stores.

Classifications

1. Degree of protection against electric shock: not classified
2. Degree of protection against ingress of water: IP40
3. Equipment not suitable for use in the presence of a flammable anesthetic mixture with air, oxygen or nitrous oxide.
4. Mode of operation: Continuous

General Cleaning Tips

Please keep the following precautions in mind while understanding the details fully before and during any cleaning of the computer and any components within.

A piece of dry cloth is ideal to clean the device.

1. Be cautious of any tiny removable components when using a vacuum cleaner to absorb dirt on the floor.
2. Turn the system off before clean up the computer or any components within.
3. Avoid dropping any components inside the computer or getting circuit board damp or wet.
4. For cleaning, be cautious of all kinds of cleaning solvents or chemicals which may cause allergy to certain individuals.
5. Keep foods, drinks or cigarettes away from the computer.

Cleaning Tools:

Although many companies have created products to help improve the process of cleaning computer and peripherals, users can also use house hold items accordingly for cleaning. Listed below are items available for cleaning computer or computer peripherals.

Pay special attention to components requiring designated products for cleaning as mentioned below.

- Cloth: A piece of cloth is the best tool to use when rubbing up a component. Although paper towels or tissues can be used on most hardware as well, it is recommended to use a piece of cloth.
- Water or rubbing alcohol: A piece of cloth may be somewhat moistened with water or rubbing alcohol before being rubbed on the computer. Unknown solvents may be harmful to plastic parts.
- Absorb dust, dirt, hair, cigarette and other particles outside of a computer can be one of the best methods of cleaning a computer. Over time these items may restrict the airflow in a computer and cause circuitry to corrode.
- Cotton swabs: Cotton swaps moistened with rubbing alcohol or water are applicable to reach areas in keyboard, mouse and other areas.
- Foam swabs: If possible, it is better to use lint free swabs such as foam swabs.



【Note】 : *It is strongly recommended that customer should shut down the system before start to clean any single components.*

Please follow the steps below:

1. Close all application programs;
2. Close operating software;
3. Turn off power switch;
4. Remove all devices;
5. Pull out power cable.

Scrap Computer Recycling

Please inform the nearest Axiomtek distributor as soon as possible for suitable solutions in case computers require maintenance or repair; or for recycling in case computers are out of order.

Trademarks Acknowledgments

Axiomtek is a trademark of Axiomtek Co., Ltd.

IBM, PC/AT, PS/2, VGA are trademarks of International Business Machines Corporation. Intel[®] and Pentium[®] are registered trademarks of Intel Corporation.

MS-DOS, Microsoft C and QuickBasic, Windows 10, Windows 8.1, Windows 8, Windows 7, Windows XPE, Windows XP, Windows CE embedded, Linux are trademarks of Microsoft Corporation.

Other brand names and trademarks are the properties and registered brands of their respective owners.

Table of Contents

Disclaimers.....	ii
Safety Precautions.....	iii
Classifications.....	iv
General Cleaning Tips	v
Scrap Computer Recycling.....	vi
SECTION 1 INTRODUCTION.....	1
1.1 General Descriptions.....	1
1.2 System Specifications	2
1.2.1 CPU	2
1.2.2 I/O System	3
1.2.3 System Specifications.....	4
1.2.4 Driver CD Contents.....	4
1.3 Dimensions	5
1.3.1 System Dimensions.....	5
1.3.2 Wall-mount Bracket Dimensions (A).....	6
1.4 I/O Outlets	10
1.5 Packing List.....	11
1.6 Model List.....	12
SECTION 2 HARDWARE INSTALLATION.....	13
2.1 Installation of 2.5" SATA Device	13
2.2 Installation of SO-DIMM.....	15
2.3 Installation of Mini PCIe Module (full-size)	16
SECTION 3 JUMPER & CONNECTOR SETTINGS.....	17
3.1 Locations of Jumpers & Connectors.....	17
3.2 Summary of Jumper Settings	19
3.2.1 Restore BIOS Optimal Defaults (JP2)	20
3.2.2 Auto Power On (SW3).....	20
3.3 Connectors	21
3.3.1 DC Power Jack Connector (screw type).....	22
3.3.2 Serial Port Connector (COM 1).....	22
3.3.3 HDMI Connector.....	23
3.3.4 Ethernet Ports (LAN1 and LAN2).....	24
3.3.5 ATX Power On/Off button	24
3.3.6 Reset button	25
3.3.7 Remote Power Switch Connector	25
3.3.8 USB 2.0 Port (CN1/11).....	25
3.3.9 USB 3.0 Port (USB 1)	26
3.3.10 SATA/SATA Power connector (SATA 1)	27
3.3.11 Full-size PCI-Express Mini Card Connector (CN4/CN6).....	28
3.3.12 SIM Card slot (CN5).....	29
SECTION 4 BIOS SETUP UTILITY	31
4.1 Starting	31
4.2 Navigation Keys.....	31

4.3	Main Menu	32
4.4	Advanced Menu	33
4.5	Chipset Menu	42
4.6	Security Menu	46
4.7	Save & Exit Menu.....	48
APPENDIX A WATCHDOG TIMER.....		51
	About Watchdog Timer	51
	Sample Program	52

SECTION 1 INTRODUCTION



This section contains general information and detailed specifications of the eBOX100-312-FL. Section 1 consists of the following sub-sections:

- General Descriptions
- System Specifications
- Dimensions
- I/O Outlets
- Packing List
- Model List

1.1 General Descriptions

A fan-less embedded system with Intel® Celeron® processor N3350 dual core (formally codename: Apollo Lake) or Intel® Pentium® processor N4200 quad core with low power consumption design. To fulfill smart retail, smart cities and light industries application needs, the entry-level embedded system supports Windows® 10 IoT and it can be wall-mounted, Din-rail mounted and VESA mounted by optional requests.

The eBOX100-312-FL comes with ultra-slim size, low power consumption and fundamental features. Equipped with Intel® N3350 or N4200 Processor. Also, the eBOX100-312-FL is offering 12 voltage DC power input and four antenna connectors for WIFI/3G and LTE. Besides, the platform is compatible with Microsoft Azure certified and supports full feature I/O to connect other devices such as RFID/Sensor or display, the total solution can help users rapidly implement IoT applications and maximize performance.

Features

- Intel® Celeron® processor N3350 dual core, up to 2.4 GHz with turbo boost
Intel® Pentium® processor N4200 quad core, up to 2.5 GHz
- 1 COM port, 6 USB ports and 2 GbE LANs
- 2 HDMI output for 4K UHD content
- 2 full-size PCIe Mini Card for WLAN and WWAN
- 1 x 2.5" swappable SATA HDD/SSD drive bay for easy maintain
- Supports Jumbo Frame (9k), WoL, PXE Remote Boot
- Fan-less operation design with low power consumption
- Suitable for smart retails and light industries

Reliable and Stable Design

The embedded system equipped with Intel® Celeron® N3350 or Intel® Pentium® N4200, ultra-slim size and basic functions. It is the best solution for smart retails and light industries.

Flexible Connectivity

It comes with basic interfaces including one RS-232 port, two USB 3.0 ports, four USB 2.0 ports, two HDMI, two GbE LAN ports.

Embedded O.S. Supported

The eBOX100-312-FL supports Windows® 10 IoT and Linux.

Easy maintain storage Supported

In terms of storage, the eBOX100-312-FL supports one swappable 2.5" SATA storage drive bay for easy maintain.

1.2 System Specifications

1.2.1 CPU

- **CPU**
 - Intel® Celeron® processor N3350 Dual Core, up to 2.4 GHz with turbo boost.
 - Intel® Pentium® processor N4200 Quad Core, up to 2.5 GHz.
- **Chipset**
 - SoC integrated
- **BIOS**
 - American Megatrends Inc. UEFI (Unified Extensible Firmware Interface) BIOS.
- **System Memory**
 - One 204-pin DDR3L-1600 SO-DIMM socket, up to 8 GB at the maximum.

1.2.2 I/O System

- **Display**
 - 2 x HDMI (HDMI 1.4b up to 3840 x 2160@30Hz)
- **Ethernet**
 - 2 x 10/100/1000 Ethernet ports (i211AT)
- **USB Ports**
 - 4 x USB 2.0
 - 2 x USB 3.0
- **Serial Ports**
 - 1 x RS-232 (9-pin D-Sub male connector)
- **Mini PCIe Interface**
 - 2 x full-size PCI Express Mini Card Slots (USB + PCI Express signal)
- **Storage**
 - 1 x 2.5" swappable SATA HDD/SSD drive bay
 - 1 x SIM slot
- **Indicator**
 - 1 x Green LED as indicator for PWR status
 - 1 x Yellow LED as indicator for HDD active
- **Switch**
 - 1 x ATX PWR switch
 - 1 x Remote PWR switch
 - 1 x ATX/AT Quick switch
 - 1 x Reset switch
- **Antenna**
 - 4 x SMA type connector openings for antenna

1.2.3 System Specifications

- **Watchdog Timer**
 - 1~255 seconds or minutes; up to 255 levels.
- **Power Supply**
 - 12VDC /36W AC to DC adapter
- **Operation Temperature**
 - -5°C ~+60°C (23 °F ~ 140°F), with W.T. SSD & Memory
 - -5°C ~+50°C (23 °F ~ 122°F), with W.T. HDD & Memory
- **Humidity**
 - 10% ~ 95% (non-condensation)
- **Vibration Endurance**
 - 3Grm with SSD(5-500Hz, X, Y, Z directions)
- **Weight**
 - 1.15 kg (2.53 lb) without package
 - 1.50 kg (3.3 lb) with package
- **Dimension**
 - 216 mm (8.5") x 137.65 mm (5.41") x 44 mm (1.73")

1.2.4 Driver CD Contents

- Ethernet
- Chipset
- Graphic
- Serial Port
- USB 3.0
- Intel® ME
- User Manual
- Quick Manual



【Note】 : All specifications and images are subject to change without notice.

1.3 Dimensions

The following diagrams show dimensions and outlines of the eBOX100-312-FL.

1.3.1 System Dimensions

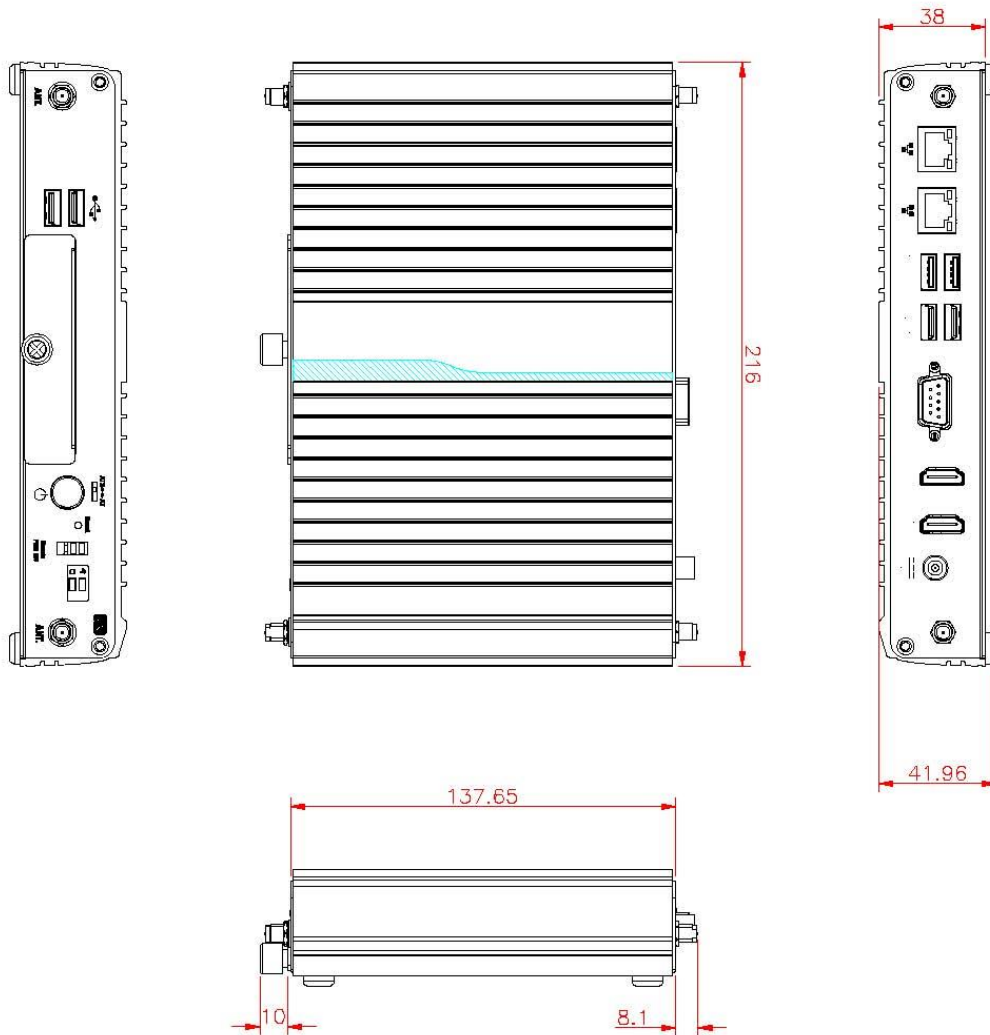

1.3.2 Wall-mount Bracket Dimensions (A)

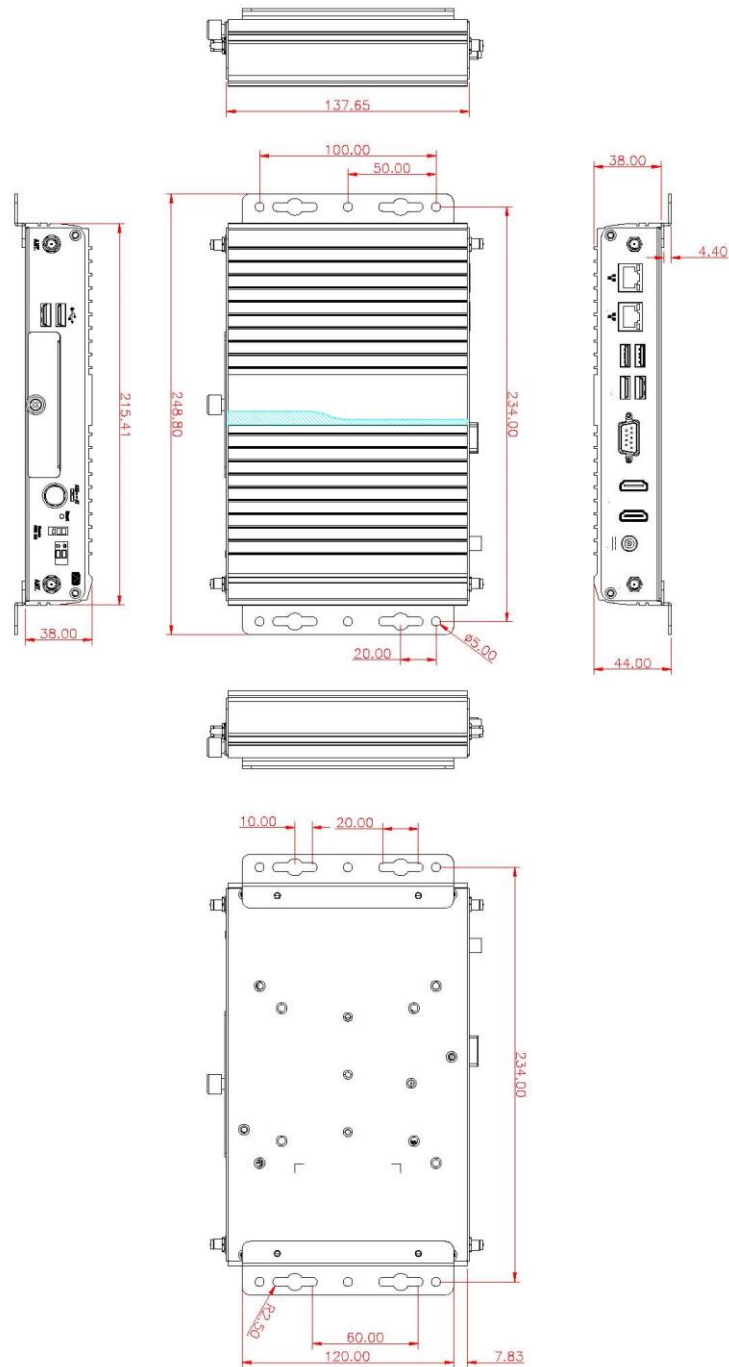

Instruction

Step 1: Before install the wall mount kit, please remove the four foot pads, and screw the two pieces of wall-mount kits to the bottom plate of the device.
Total four screws (metric 3 x6) are required.

Step 2: Use the device, with wall mount plate attached, as a guide to mark the correct locations of the four screws.

Step 3: Insert a tapping-screw (thread diameter less than 4mm) head through middle of the keyhole-shaped aperture on the plate, and then slide the device downwards.
Tighten the screw head for added stability.

1.3.3 Wall-mount Bracket Dimensions (B)

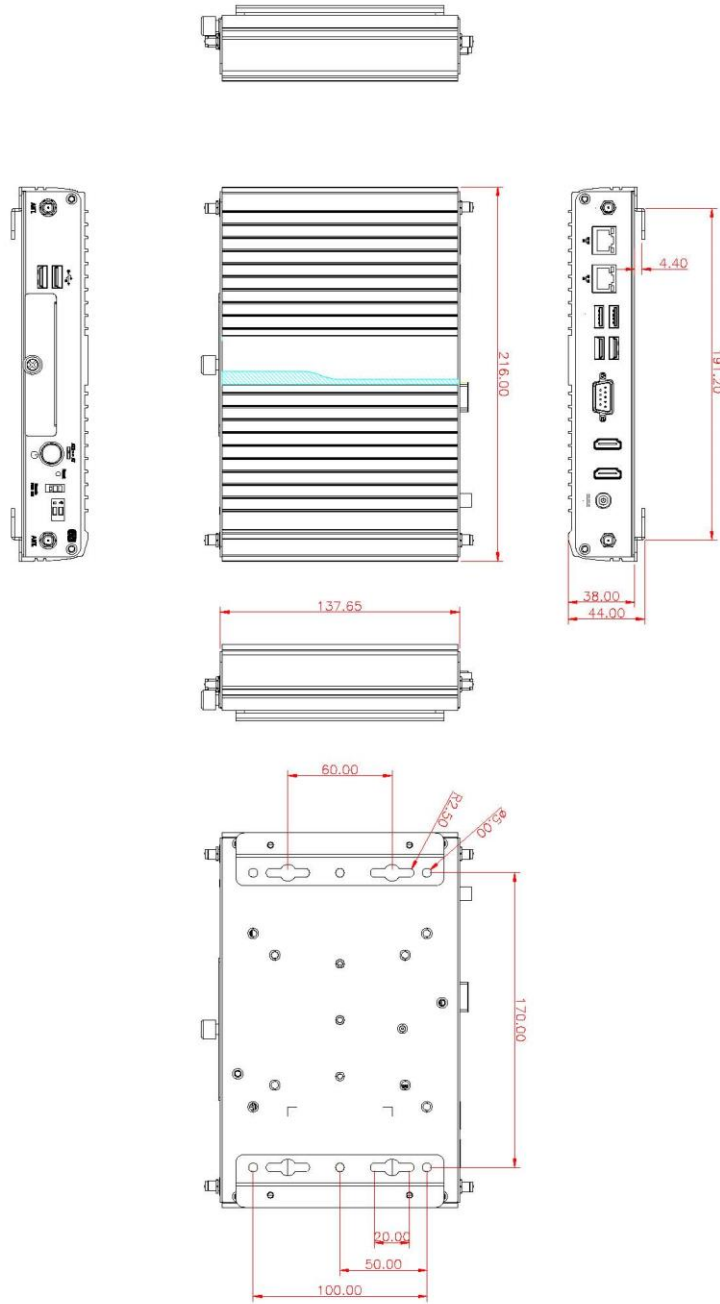

Instruction

Step 1: Before install the wall mount kit, please remove the four foot pads, and screw the two pieces of wall-mount kits to the bottom plate of the device. Total four screws (metric 3 x6) are required.

Step 2: Use the device, with wall mount plate attached, as a guide to mark the correct locations of the four screws.

Step 3: Insert a tapping-screw (thread diameter less than 4mm) head through middle of the keyhole-shaped aperture on the plate, and then slide the device downwards. Tighten the screw head for added stability.

1.3.4 Din-Rail kit Dimensions

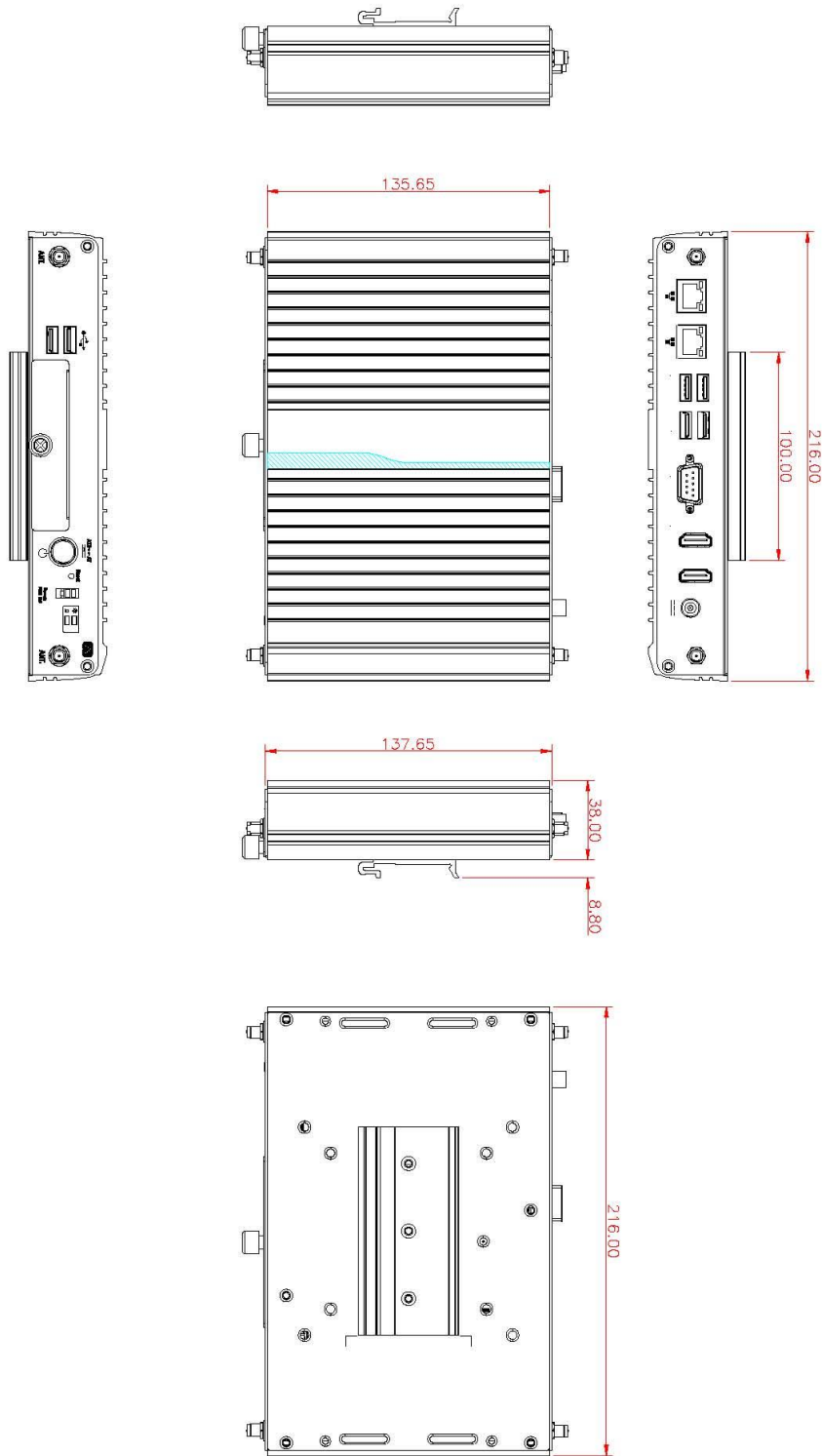

Instruction

Step 1: Screw the Din rail mount Bracket to the bottom plate of the device. Total of four screws (Flat Head M3 x4) are required.

Step 2: Users can install the eBOX100 in din-rail bracket through din-rail bracket kit.

1.3.5 VESA Mount Dimensions

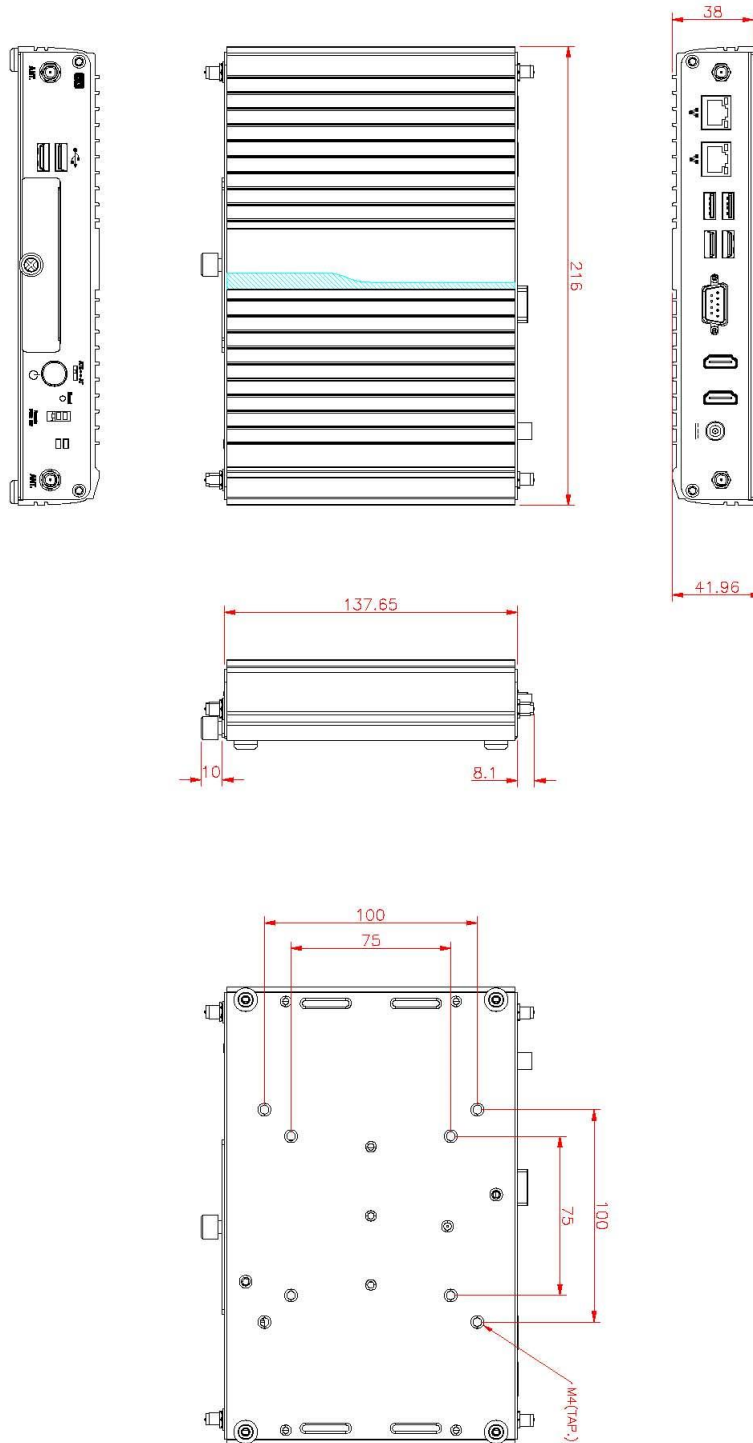

Instruction

Step 1: Please refer to above photo to screw the VESA mount bracket kit with the bottom plate of the device. Total four screws (metric 4 x6) are required.

Step 2: Insert four screws into the VESA hole of monitor and reserved a gap about 1.2~1.5mm.

Step 3: Users can hang the eBOX100 through VESA bracket on the monitor.

1.4 I/O Outlets

The following figures show I/O outlets on the eBOX100-312-FL.

Front View

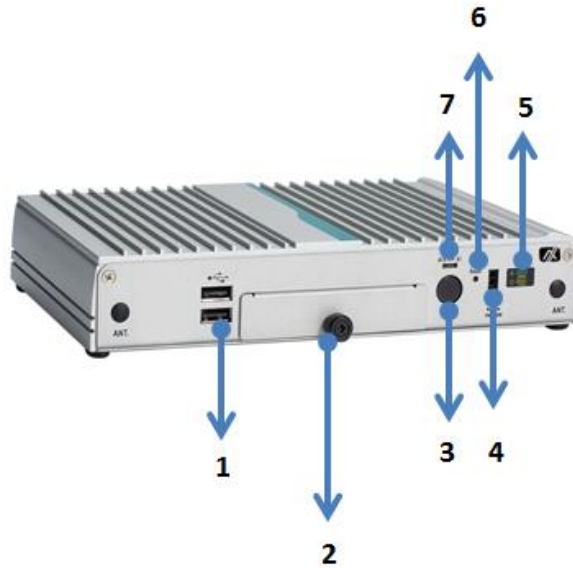

Rear View

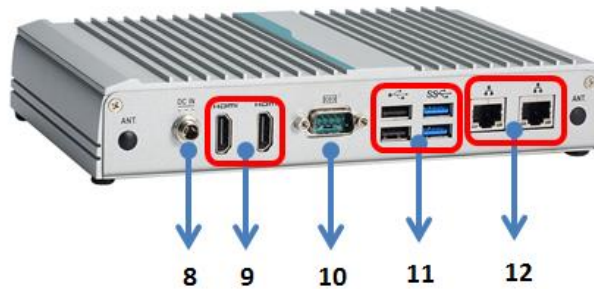

1	2 x USB 2.0	7	ATX/AT quick switch
2	1 x swappable HDD drive bay	8	12VDC power input
3	1 x Power button	9	2 x HDMI
4	1 x Remote PWR switch	10	1 x Serial port
5	2 x LEDs for HDD and Power	11	2 x USB 2.0 2 x USB 3.0
6	1 x Reset switch	12	2 x LAN Port

1.5 Packing List

The eBOX100-312-FL comes with the following bundle package:

- eBOX100-312-FL System Unit x 1
- Quick Installation Guide x 1
- DVD x 1 (For Driver and Manual)
- HDD Screw x 1
- HDD Rubber x 1
- Remote switch cable x 1
- Foot Pad x 4 (Pre-install)
- Optional Screw Type AC 36W (12V/3A) Adaptor
- Optional power cord
- Optional DDR3L SO-DIMM Memory
- Optional Wall-mount kit
- Optional VESA / DIN-Rail kit
- Optional Antenna
- Optional Mini Card module
- Optional 2.5" SATA Storage

1.6 Model List

eBOX100-312-FL-DC-N3350	Fan-less embedded system with Intel® Celeron® N3350 2.4 GHz, 2 HDMI, 2 GbE LANs and 6 USB (w/o adapter and power cord)
eBOX100-312-FL-DC-N4200	Fan-less embedded system with Intel® Pentium® N4200 2.5 GHz, 2 HDMI, 2 GbE LANs and 6 USB (w/o adapter and power cord)

Please contact Axiomtek's distributors immediately in case any abovementioned items are missing.

SECTION 2 HARDWARE INSTALLATION

The eBOX100-312-FL is convenient for various hardware configurations, such as CPU, DRAM, HDD (Hard Disk Drive), SSD (Solid State Drive) and PCI Express Mini card modules. Section 2 contains guidelines for hardware installation.

2.1 Installation of 2.5" SATA Device

- Step 1** Turn off the system and unplug the power cord.
Step 2 Turn the system upside down to locate screws at the bottom and then loosen all screws.

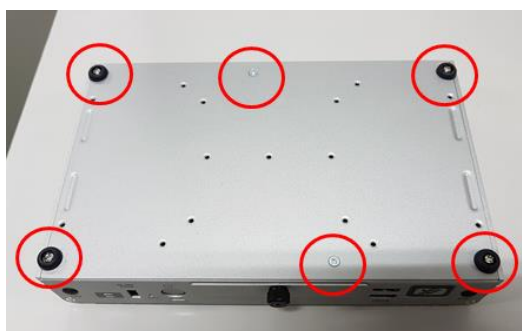

- Step 3** Open the bottom cover.

- ※ Please put the HDD rubber on bottom cover when customer uses 7.5 mm thick SSD.



- Step 4** Locate SSD/HDD within the red line as marked.
Please notice the direction of connector for HDD.

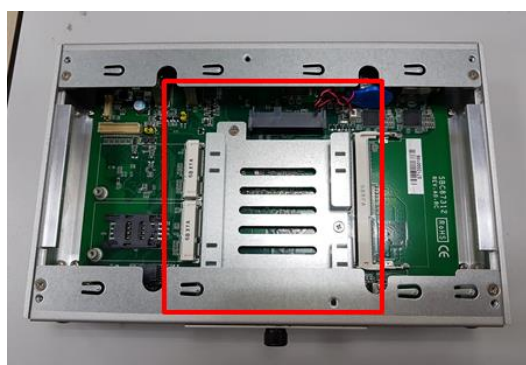

Step 5 Before assemble the SSD/HDD, please loosen the thumb screw to remove the HDD bracket, and then assemble the SSD/HDD with the one HDD mounting screw.



Step 6 Put the bottom cover back and fasten all the screws.

Step 7 Turn the system up and then connected the SSD/HDD directly and make sure the insertion is complete

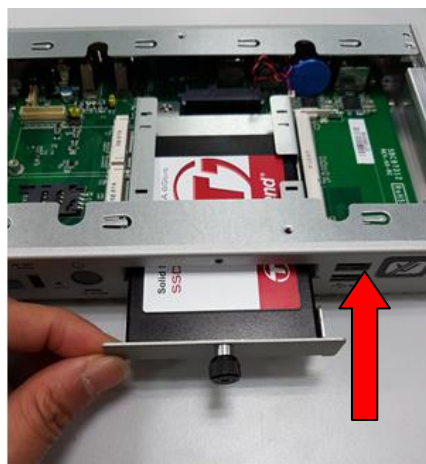

2.2 Installation of SO-DIMM

- Step 1** Turn off the system and unplug the power cord.
Step 2 Turn the system upside down to locate screws at the bottom and then loosen all screws.



- Step 3** Located the SO-DIMM socket on main board.



- Step 4** Locate the memory module, insert a gold colored contact into the socket and push the module two end latches till locked.

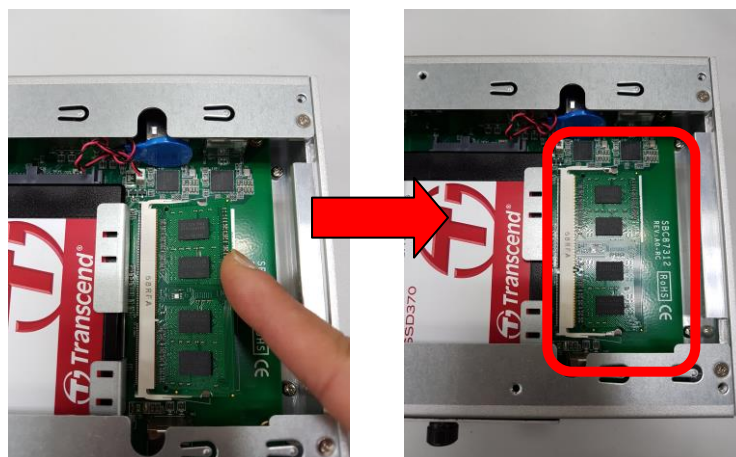

- Step 5** Put the bottom cover and fasten six screws back onto the system.

2.3 Installation of Mini PCIe Module (full-size)

Step 1 Turn off the system and unplug the power cord.

Step 2 Turn the system upside down to locate screws at the bottom, and then loosen all screws.



Step 3 Identify the two full-size mini PCIe slots, insert a mini PCIe module into the socket and then fasten a screw.

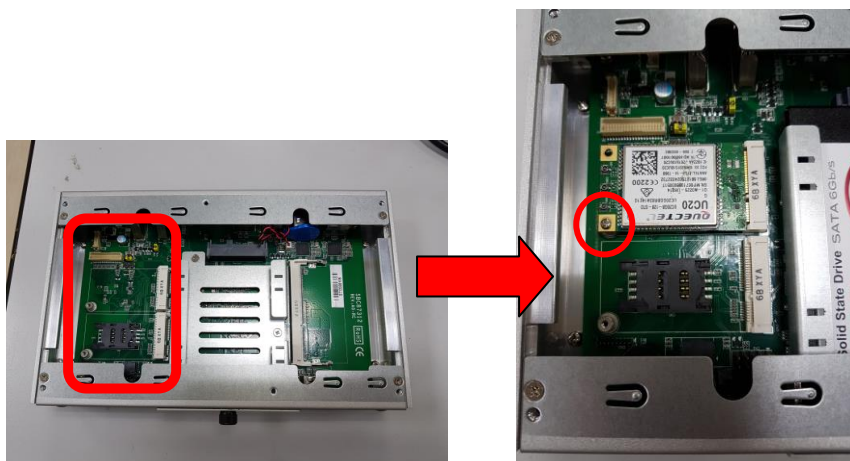

Step 4 Put the bottom cover and fasten six screws back onto the system.

SECTION 3 JUMPER & CONNECTOR SETTINGS

Proper jumper settings configure the eBOX100-312-FL to meet various application needs. Hereby all jumpers settings along with their default settings are listed for devices onboard.

3.1 Locations of Jumpers & Connectors

SBC87312 Top View

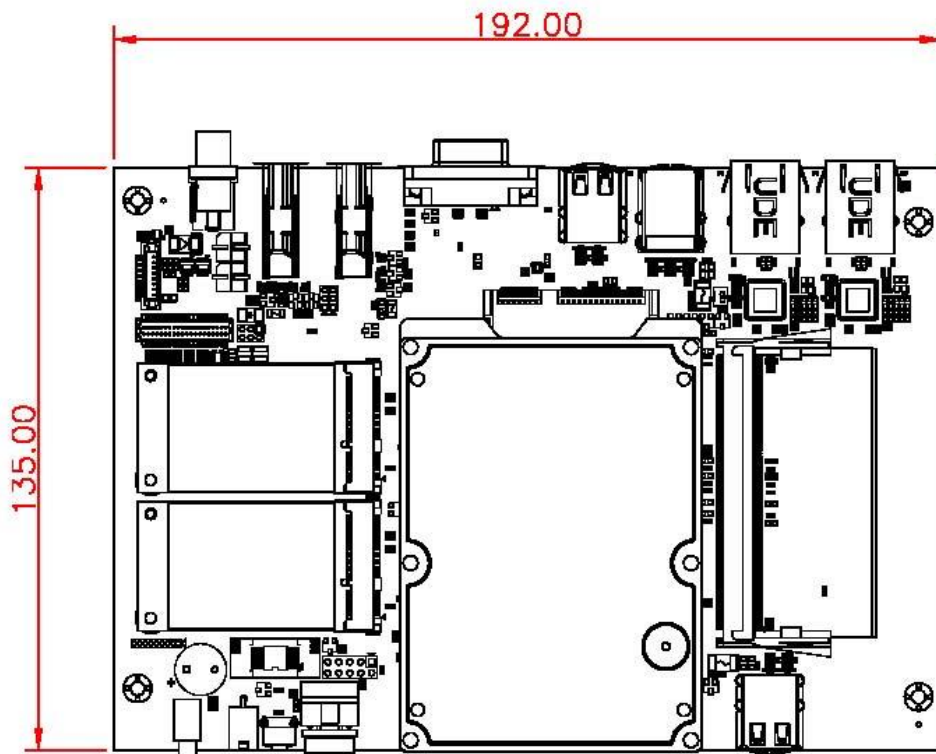

SBC87312 Bottom View

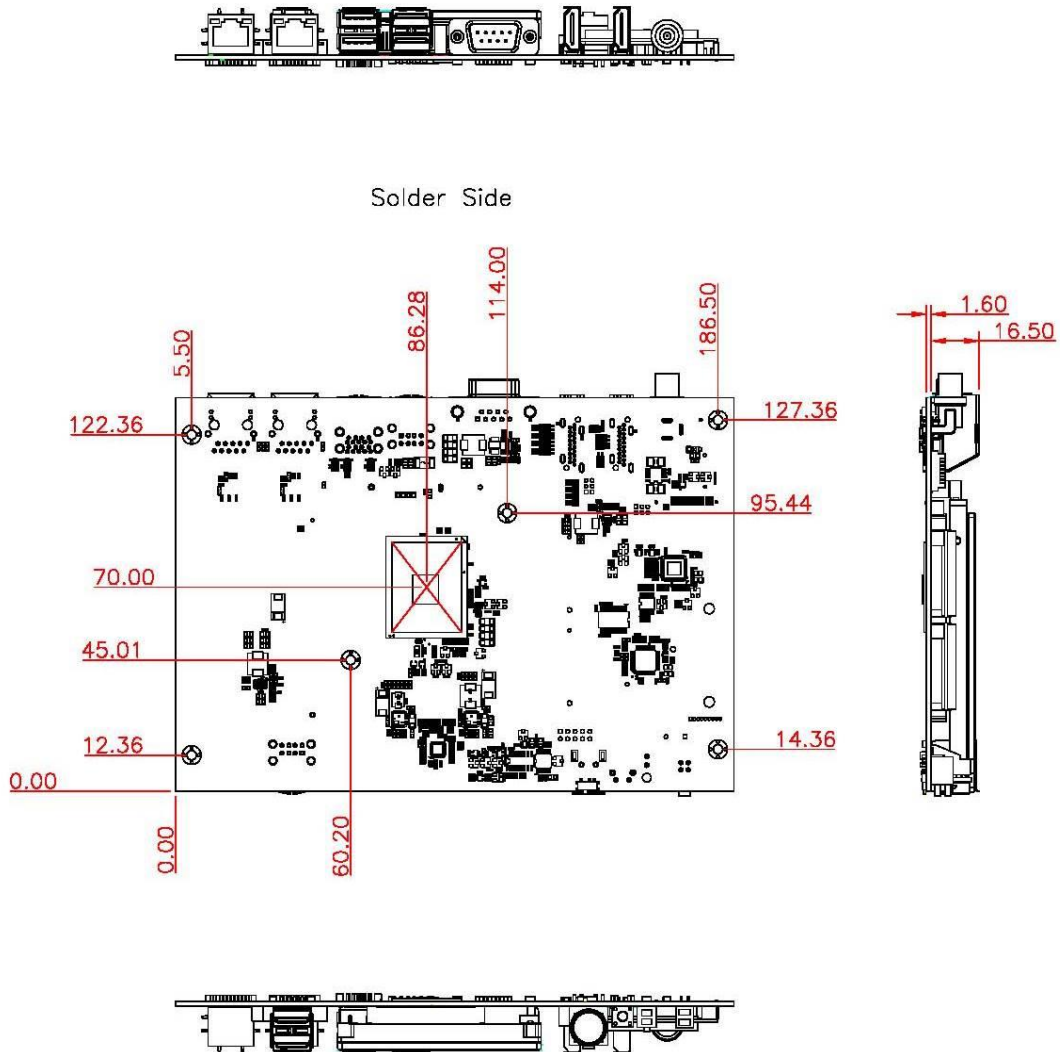

【Note】 : It is strongly recommended that any unmentioned jumper settings should not be modified without instructions by Axiomtek FAEs. Any modifications without instructions might cause system failure.

3.2 Summary of Jumper Settings

Proper jumper settings configure the eBOX100-312-FL to meet various application purposes. A table of all jumpers and their default settings is listed below.

Jumper and Switch	Descriptions	Settings
JP2	Restore BIOS Optimal Defaults Default: Normal Operation	1-2 Close
SW3	ATX/ AT quick switch	Default: ATX Mode



【Note】 : How to setup Jumpers

That a cap on a jumper is to “close” the jumper, whereas that offs a jumper is to “open” the jumper.

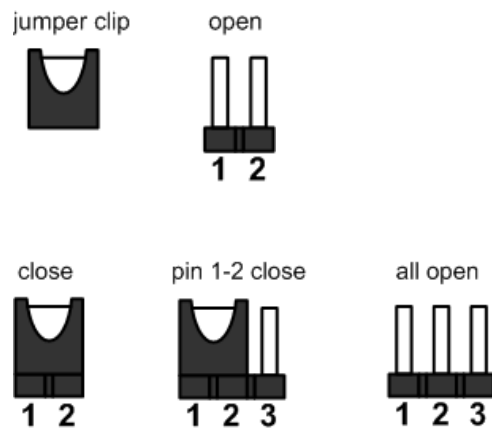

【Note】 : Once the default jumper or switch setting needs to be changed, please do it under power-off condition.

3.2.1 Restore BIOS Optimal Defaults (JP2)

Put jumper clip to pin 2-3 for a few seconds then move it back to pin 1-2. This procedure is to restore BIOS optimal defaults.

Functions	Settings
Normal (Default)	1-2 close
Restore BIOS optimal defaults	2-3 close



3.2.2 Auto Power On (SW3)

If SW3 is enabled for power input, the system will be automatically power on without pressing soft power button. If SW3 is disabled for power input, it is necessary to manually press soft power button to power on the system.

Functions
AT Mode
ATX Mode (Default)

3.3 Connectors

Please refer to pin assignments below:

External Connectors	Sections
DC Power Jack	3.3.1
COM1 Connector	3.3.2
HDMI Connector	3.3.3
Ethernet Connector 1 and 2	3.3.4
ATX Power On/Off Button	3.3.5
Reset Button	3.3.6
Remote Power Switch Connector	3.3.7
USB 2.0 connector	3.3.8
USB 3.0 connector	3.3.9
Internal Connectors	Sections
Serial ATA (SATA) Connector with Power	3.3.10
SIM Card Slot	3.3.11
Full-Size Express Mini Card slot	3.3.12

3.3.1 DC Power Jack Connector (screw type)

The system supports 12V DC-in connector for system power input. The CN12 is a DC jack with screw. Firmly insert at least 36W adapter into this connector. Loose connection may cause system instability and make sure all components/devices are properly installed before connecting

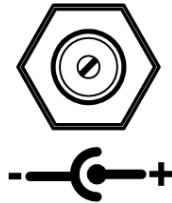

3.3.2 Serial Port Connector (COM 1)

The system has one serial port. COM 1 is RS-232 port.

Pins	Signals
1	DCD
2	RXD
3	TXD
4	DTR
5	GND
6	DSR
7	RTS
8	CTS
9	RI

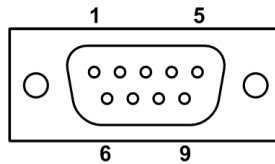

3.3.3 HDMI Connector

The HDMI (High-Definition Multimedia Interface) is a compact digital interface which is capable of transmitting high-definition video and high-resolution audio over a single cable.

Pins	Signals	Pins	Signals
1	HDMI OUT_DATA2+	2	GND
3	HDMI OUT_DATA2-	4	HDMI OUT_DATA1+
5	GND	6	HDMI OUT_DATA1-
7	HDMI OUT_DATA0+	8	GND
9	HDMI OUT_DATA0-	10	HDMI OUT_Clock+
11	GND	12	HDMI OUT_Clock-
13	N.C.	14	N.C.
15	HDMI OUT_SCL	16	HDMI OUT_SDA
17	GND	18	+5V
19	HDMI_HTPLG		

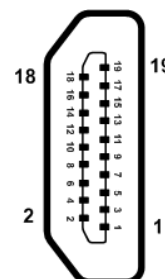

3.3.4 Ethernet Ports (LAN1 and LAN2)

The system has two RJ-45 connectors: LAN1 and LAN2. Ethernet connection can be established by plugging one end of the Ethernet cable into this RJ-45 connector and the other end (phone jack) to a 1000/100/10-Base-T hub.

Pins	1000 Base-T	100/10 Base-T	Descriptions
L1	BI_DA+	TX+	Bidirectional or Transmit Data+
L2	BI_DA-	TX-	Bidirectional or Transmit Data-
L3	BI_DB+	RX+	Bidirectional or Receive Data+
L4	BI_DC+	N.C.	Bidirectional or Not Connected
L5	BI_DC-	N.C.	Bidirectional or Not Connected
L6	BI_DB-	RX-	Bidirectional or Receive Data-
L7	BI_DD+	N.C.	Bidirectional or Not Connected
L8	BI_DD-	N.C.	Bidirectional or Not Connected
A	Active Link LED (Yellow) Off: No link Blinking: Data activity detected		
B	Speed LED 1000: Orange 100: Green 10: OFF		

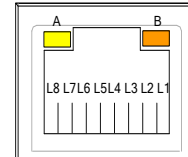

3.3.5 ATX Power On/Off button

The ATX power button is on the I/O side. It can allow users to control eBOX100-312-FL power on/off.

Functions	Descriptions
On	Turn on/off system
Off	Keep system status



3.3.6 Reset button

The Reset button can allow users to reset eBOX100-312-FL during system abnormal situation.

Functions	Descriptions
On	Reset system
Off	Keep system status



3.3.7 Remote Power Switch Connector

One 2-pin connector output for remote power on/off switch.

Functions	Descriptions
Short(1-2)	Turn on/off system
Open	Keep system status

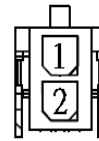

3.3.8 USB 2.0 Port (CN1/11)

The CN1/CN11 is a Universal Serial Bus (compliant with USB 2.0 (480Mbps)) connector on the rear I/O. It is commonly used for installing USB peripherals such as keyboard, mouse, scanner, etc.

Pins	Signals	Pins	Signals
1	USB VCC (+5V_SBY)	5	USB VCC (+5V_SBY)
2	USB #2_D-	6	USB #3_D-
3	USB #3_D+	7	USB #3_D+
4	GND	8	GND

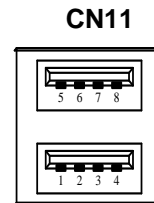

Pins	Signals	Pins	Signals
1	USB VCC (+5V_SBY)	5	USB VCC (+5V_SBY)
2	USB #4_D-	6	USB #5_D-
3	USB #4_D+	7	USB #5_D+
4	GND	8	GND

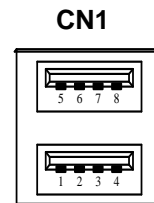

3.3.9 USB 3.0 Port (USB 1)

The Universal Serial Bus (compliant with USB 3.0 (5Gb/s)) connector on the rear I/O is for installing USB peripherals such as keyboard, mouse, scanner, etc.

USB 3.0 port 1 and 2:

Pins	Signals	Pins	Signals
1	USB_VCC (+5V_SBY)	10	USB_VCC (+5V_SBY)
2	USB #0_D-	11	USB #1_D-
3	USB #0_D+	12	USB #1_D+
4	GND	13	GND
5	SSRX0-	14	SSRX1-
6	SSRX0+	15	SSRX1+
7	GND	16	GND
8	SSTX0-	17	SSTX1-
9	SSTX0+	18	SSTX1+

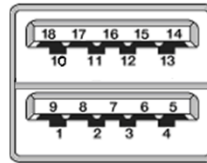

3.3.10 SATA/SATA Power connector (SATA 1)

SATA1 connector supports one 2.5" HDD/SSD.

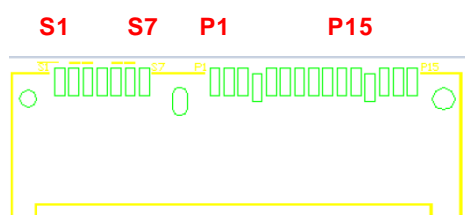

Pins	Signals	Pins	Signals
S1	GND	P1	+3.3V
S2	SATA0_TX+	P2	+3.3V
S3	SATA0_TX-	P3	+3.3V
S4	GND	P4	GND
S5	SATA0_RX-	P5	GND
S6	SATA0_RX+	P6	GND
S7	GND	P7	+5V
		P8	+5V
		P9	+5V
		P10	GND
		P11	GND
		P12	GND
		P13	NC
		P14	NC
		P15	NC

3.3.11 Full-size PCI-Express Mini Card Connector (CN4/CN6)

This is a full-size PCI-Express Mini Card connector on the bottom side supporting PCI-Express x1 or USB 2.0. It also complies with PCI-Express Mini Card Spec. V1.2.

Pins	Signals	Pins	Signals
1	WAKE#	2	+3.3VSB
3	No use	4	GND
5	No use	6	+1.5V
7	CLKREQ#	8	SIM_PWR
9	GND	10	SIM_DATA
11	REFCLK-	12	SIM_CLK
13	REFCLK+	14	SIM_REST
15	GND	16	SIM_VPP
17	No use	18	GND
19	No use	20	W_DISABLE#
21	GND	22	PERST#
23	PE_RXN3	24	+3.3VSB
25	PE_RXP3	26	GND
27	GND	28	+1.5V
29	GND	30	SMB_CLK
31	PE_TXN3	32	SMB_DATA
33	PE_TXP3	34	GND
35	GND	36	USB_D6-
37	GND	38	USB_D6+
39	+3.3VSB	40	GND
41	+3.3VSB	42	No use
43	GND	44	No use
45	No use	46	No use
47	No use	48	+1.5V
49	No use	50	GND
51	No use	52	+3.3VSB

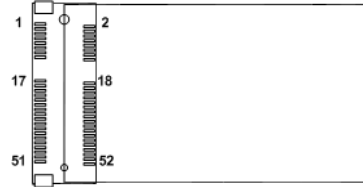

3.3.12 SIM Card slot (CN5)

This board has CN5 socket on the bottom side for inserting SIM Card. In order to work properly, the SIM Card must be used together with 3G module which is inserted to CN4 or CN6. It is mainly used in 3G wireless network application.

Pins	Signals
1	PWR
2	RST
3	CLK
4	NC
5	GND
6	VPP
7	I/O
8	NC

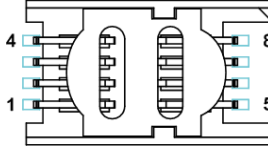

This page is intentionally left blank.

SECTION 4

BIOS SETUP UTILITY

This section provides users with detailed descriptions in terms of how to set up basic system configurations through the BIOS setup utility.

4.1 Starting

To enter the setup screens, follow the steps below:

1. Turn on the computer and press the key immediately.
2. After press the key, the main BIOS setup menu displays. Users can access to other setup screens, such as the Advanced and Chipset menus, from the main BIOS setup menu.

It is strongly recommended that users should avoid changing the chipset's defaults. Both AMI and system manufacturer have carefully set up these defaults that provide the best performance and reliability.

4.2 Navigation Keys

The BIOS setup/utility uses a key-based navigation system called hot keys. Most of the BIOS setup utility hot keys can be used at any time during the setup navigation process. These keys include <F1>, <F2>, <Enter>, <ESC>, <Arrow> keys, and so on.



【Note】 : Some of the navigation keys differ from one screen to another.

Hot Keys	Descriptions
→← Left/Right	The Left and Right <Arrow> keys allow users to select a setup screen.
↑↓ Up/Down	The Up and Down <Arrow> keys allow users to select a setup screen or sub-screen.
+– Plus/Minus	The Plus and Minus <Arrow> keys allow users to change the field value of a particular setup item.
Tab	The <Tab> key allows users to select setup fields.
F1	The <F1> key allows users to display the General Help screen.
F2	The <F2> key allows users to Load Previous Values.
F3	The <F3> key allows users to Load Optimized Defaults.
F4	The <F4> key allows users to save any changes they made and exit the Setup. Press the <F4> key to save any changes.
Esc	The <Esc> key allows users to discard any changes they made and exit the Setup. Press the <Esc> key to exit the setup without saving any changes.
Enter	The <Enter> key allows users to display or change the setup option listed for a particular setup item. The <Enter> key can also allow users to display the setup sub- screens.

4.3 Main Menu

The Main Menu screen is the first screen users see when entering the setup utility. Users can always return to the Main setup screen by selecting the Main tab. System Time/Date can be set up as described below. The Main BIOS setup screen is also shown below.



BIOS Information

Display the auto-detected BIOS information.

System Language

Choose the system default language.

System Date/Time

Use this option to change the system time and date. Highlight System Time or System Date using the <Arrow> keys. Enter new values through the keyboard. Press the <Tab> key or the <Arrow> keys to move between fields. The date must be entered in MM/DD/YY format. The time is entered in HH:MM:SS format.

Access Level

Display the access level of current user.

4.4 Advanced Menu

The Advanced menu also allows users to set configuration of the CPU and other system devices. Users can select any items in the left frame of the screen to go to sub menus:

- ▶ ACPI Settings
- ▶ CPU Configurations
- ▶ F81803 Super IO Configurations
- ▶ Hardware Monitor
- ▶ SATA Configurations
- ▶ USB Configurations
- ▶ Utility Configurations

For items marked with “▶”, please press <Enter> for more options.

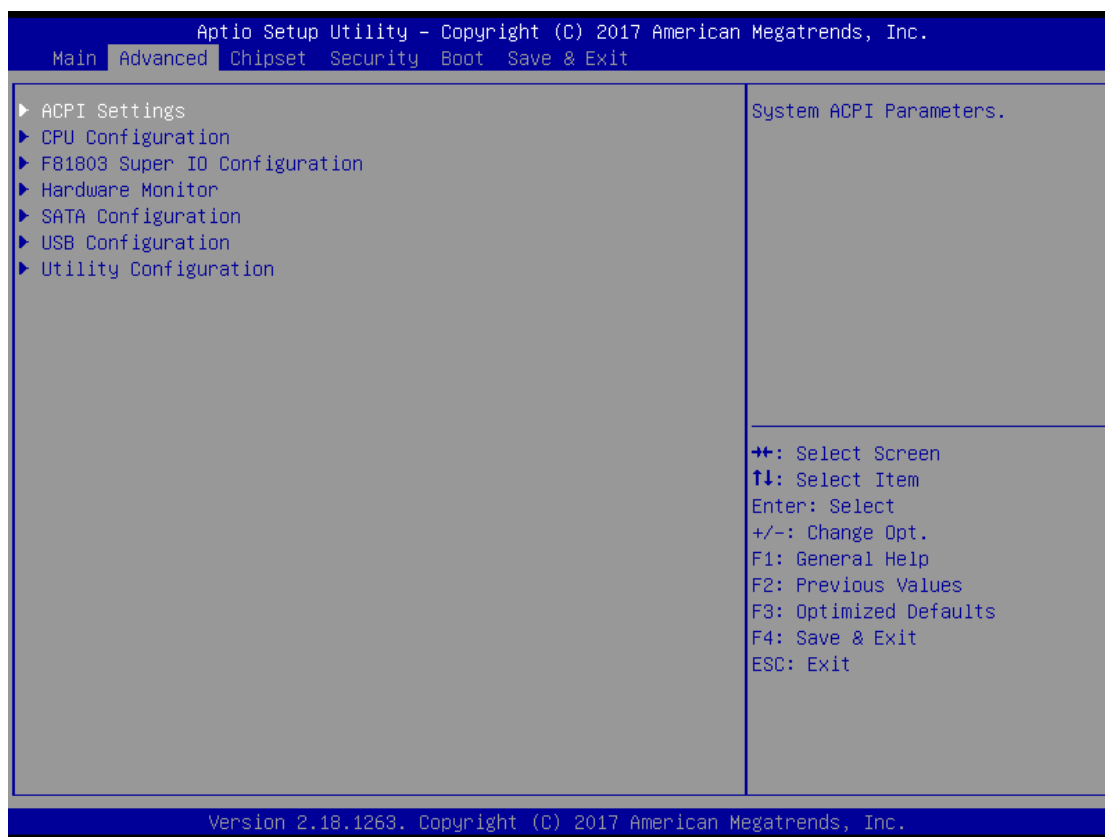

ACPI Settings

Use this screen to select options for the ACPI configuration, and change the value of the selected option. A description of the selected item appears on the right side of the screen.

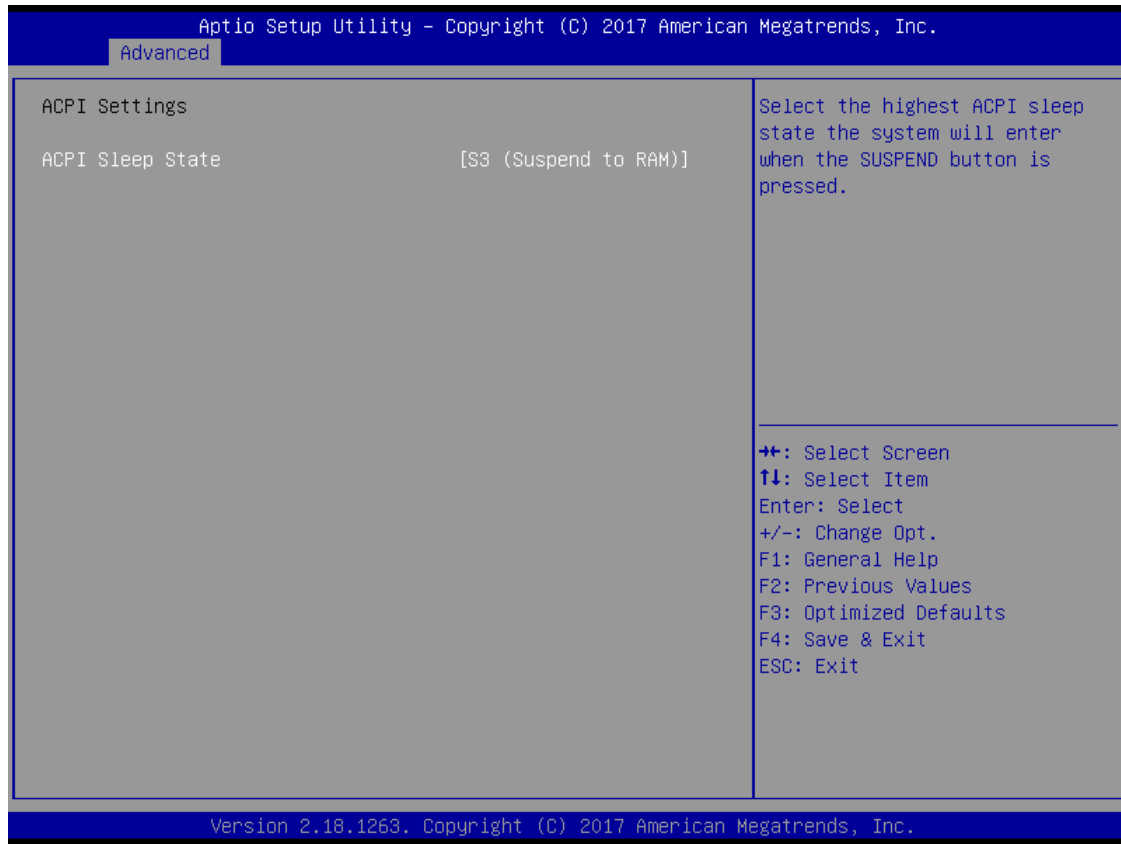

ACPI Sleep State

When the sleep button is pressed, the system will be in the ACPI sleep state.

The default is S3 (Suspend to RAM).

CPU Configurations

This screen shows the CPU version and its detailed information.

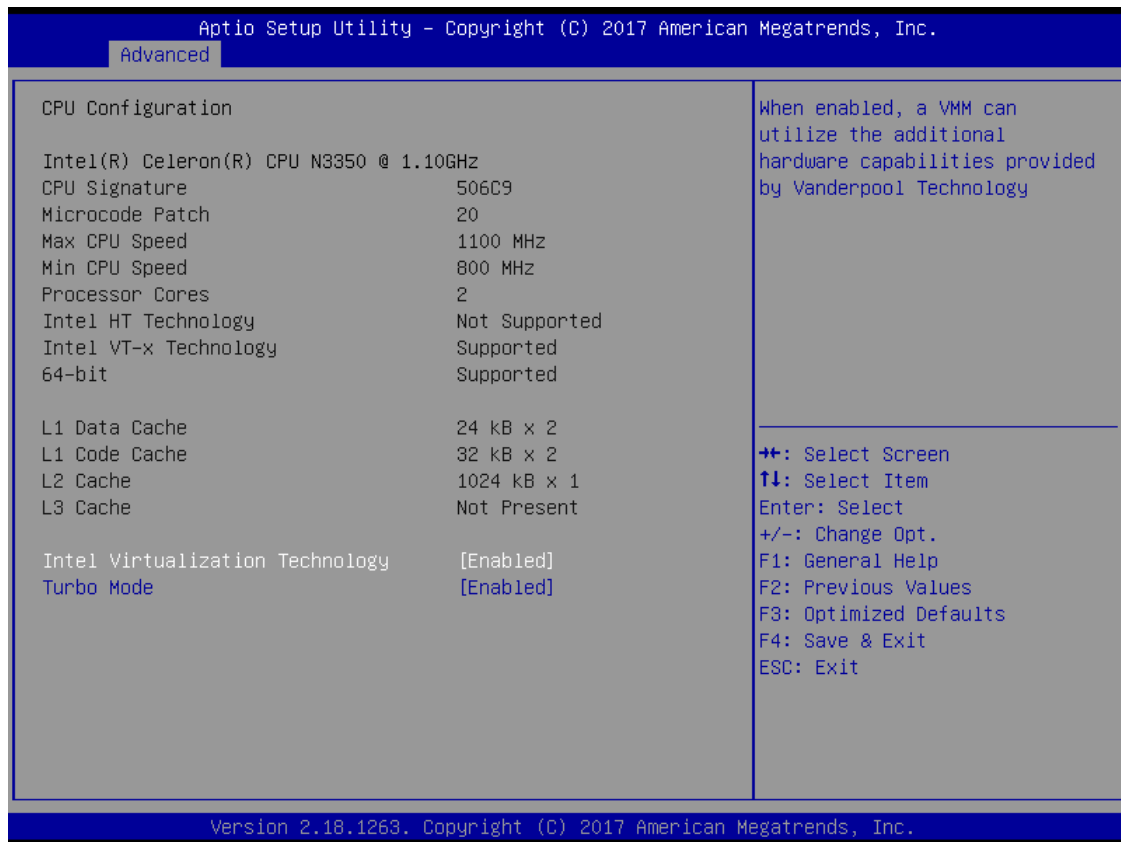

Intel Virtualization Technology

It allows a hardware platform to run multiple operating systems separately and simultaneously, enabling one system to virtually function as several systems.

Turbo Mode

System allows up to 2.4 GHz with turbo mode.

F81803 Super IO Configurations

Use this screen to select options for the F81803 Super IO Configurations, and change the value of the selected option. A description of the selected item appears on the right side of the screen. For items marked with “▶”, please press <Enter> for more options



Serial Port 1 (COM1) Configuration

Use these items to set parameters related to serial ports 1.

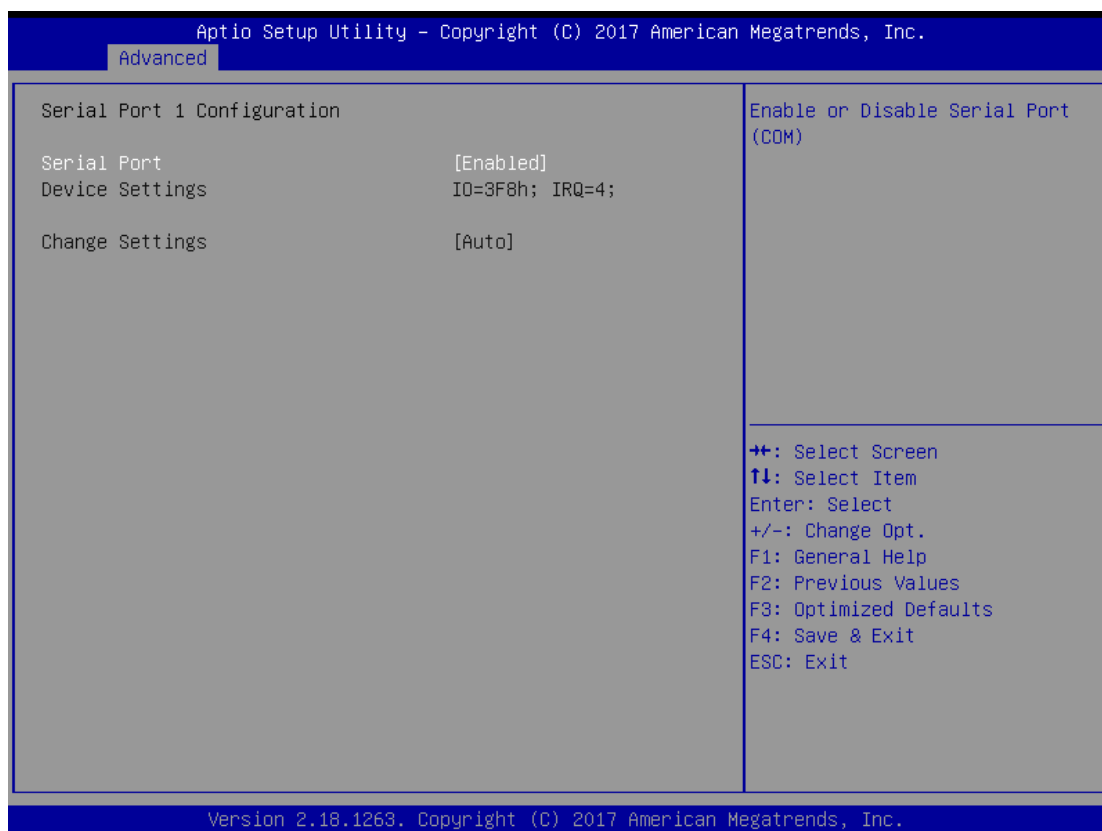

Hardware Monitor

This screen monitors hardware health status.

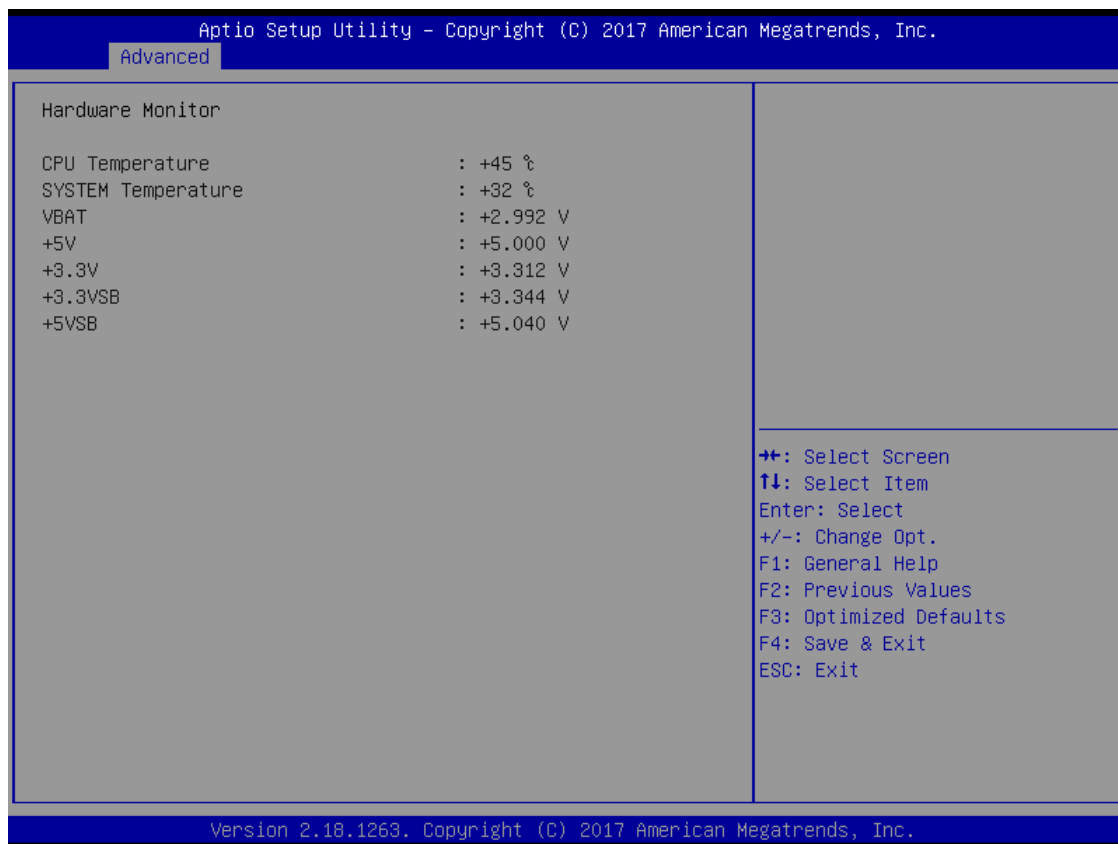

This screen displays the temperature of system and CPU, system voltages (VCORE, +3.3V, +12V and +5V).

SATA Configurations

In this Configuration menu, you can see the currently installed hardware in the SATA port. During system boot up, the BIOS automatically detects the presence of SATA device.



SATA Mode Selection

AHCI (Advanced Host Controller Interface) mode is how SATA controller(s) operate.

Serial ATA Port 0

It shows the device installed in connector SATA0.

USB Configurations

This screen specifies USB settings.

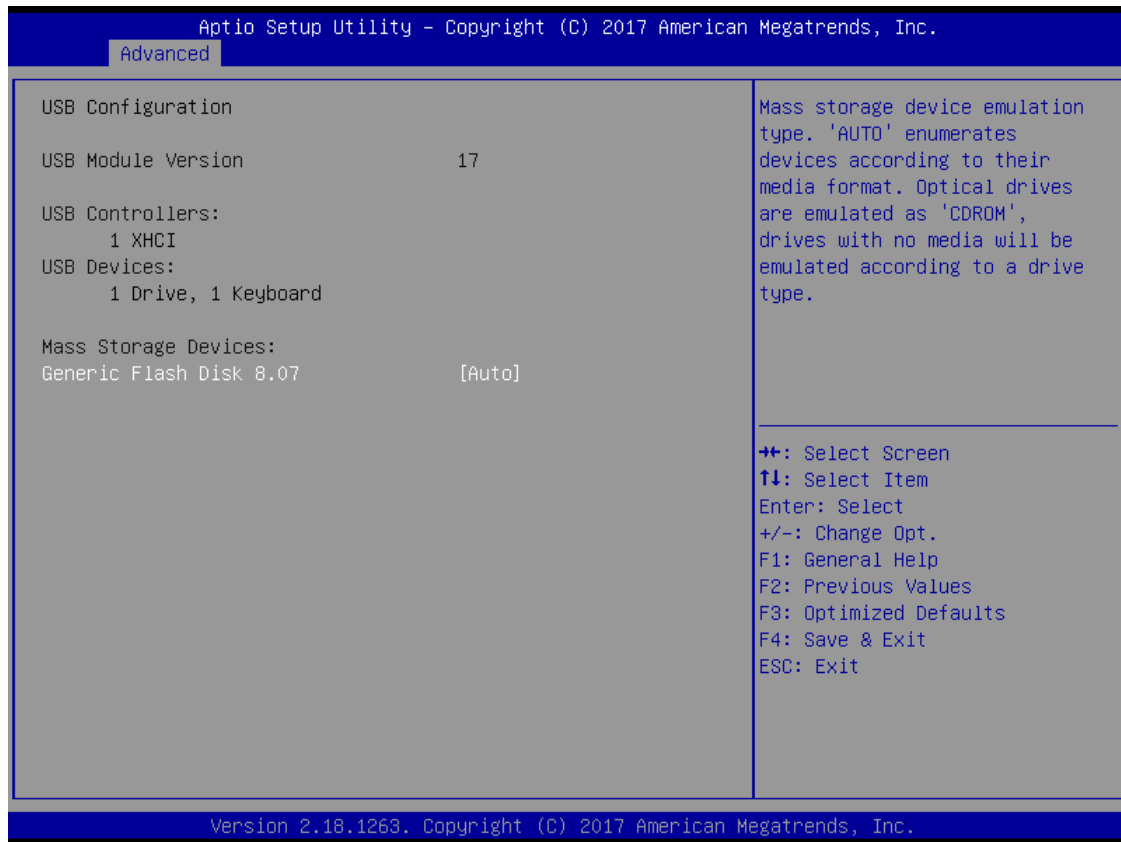

USB Devices

Display all detected USB devices.

Mass Storage Devices

Mass storage device emulation type. Auto option enumerates devices according to their media format. Optical drives are emulated as CDROM; drives with no media will be emulated according to a drive type.

Utility Configurations

This screen is for BIOS flash utility.



BIOS Flash Utility

BIOS flash utility configuration.

4.5 Chipset Menu

The Chipset menu allows users to change the advanced chipset settings. Users can select any of the items in the left frame of the screen to go to the sub menus:

- ▶ North Bridge
- ▶ South Bridge

For items marked with “▶”, please press <Enter> for more options.

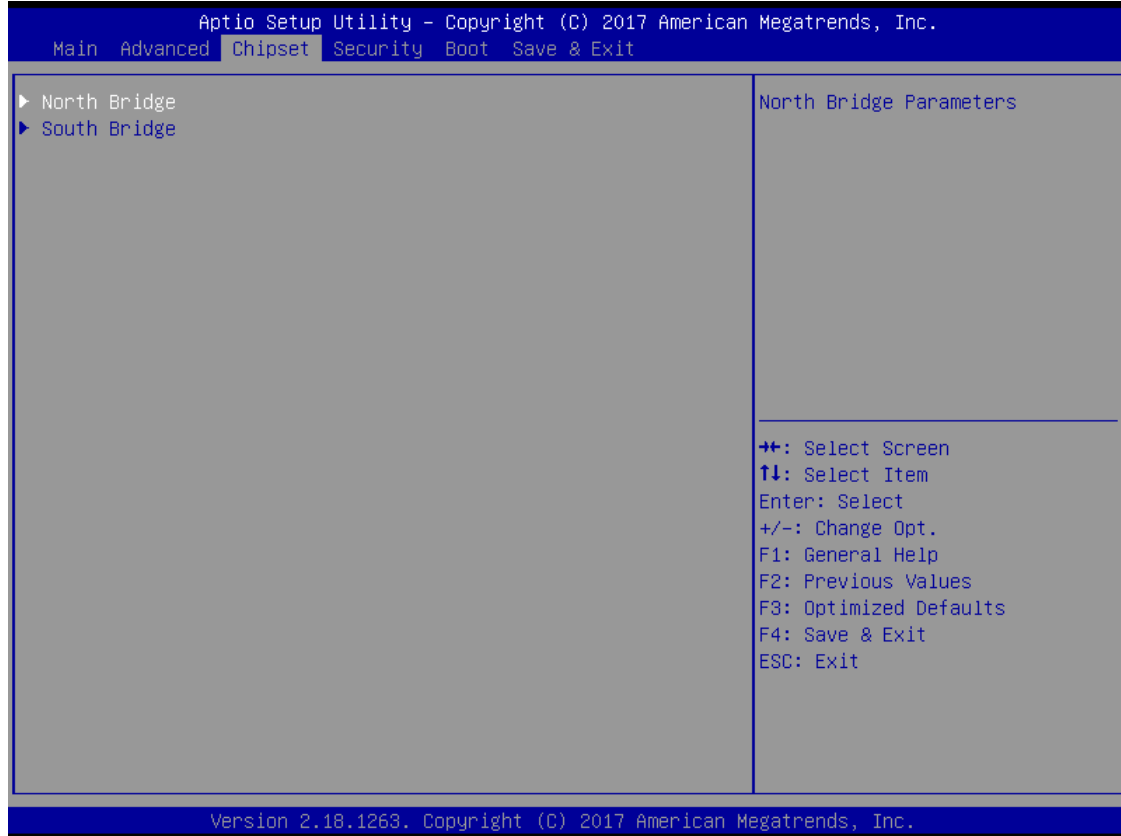

North Bridge

This screen allows users to configure parameters of North Bridge chipset.

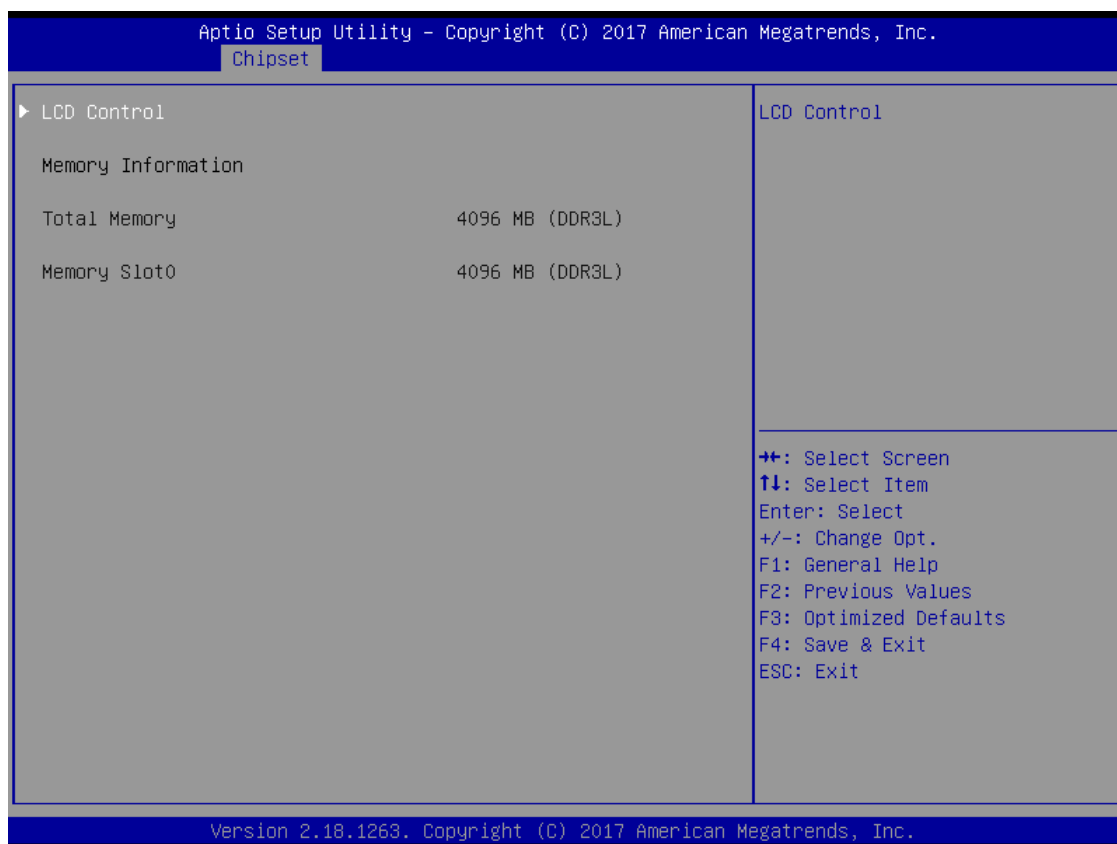

LCD Control

This item allows you to select LCD panel control options. Please press <Enter> to go to the sub menus.

Memory Information

Display system memory information.

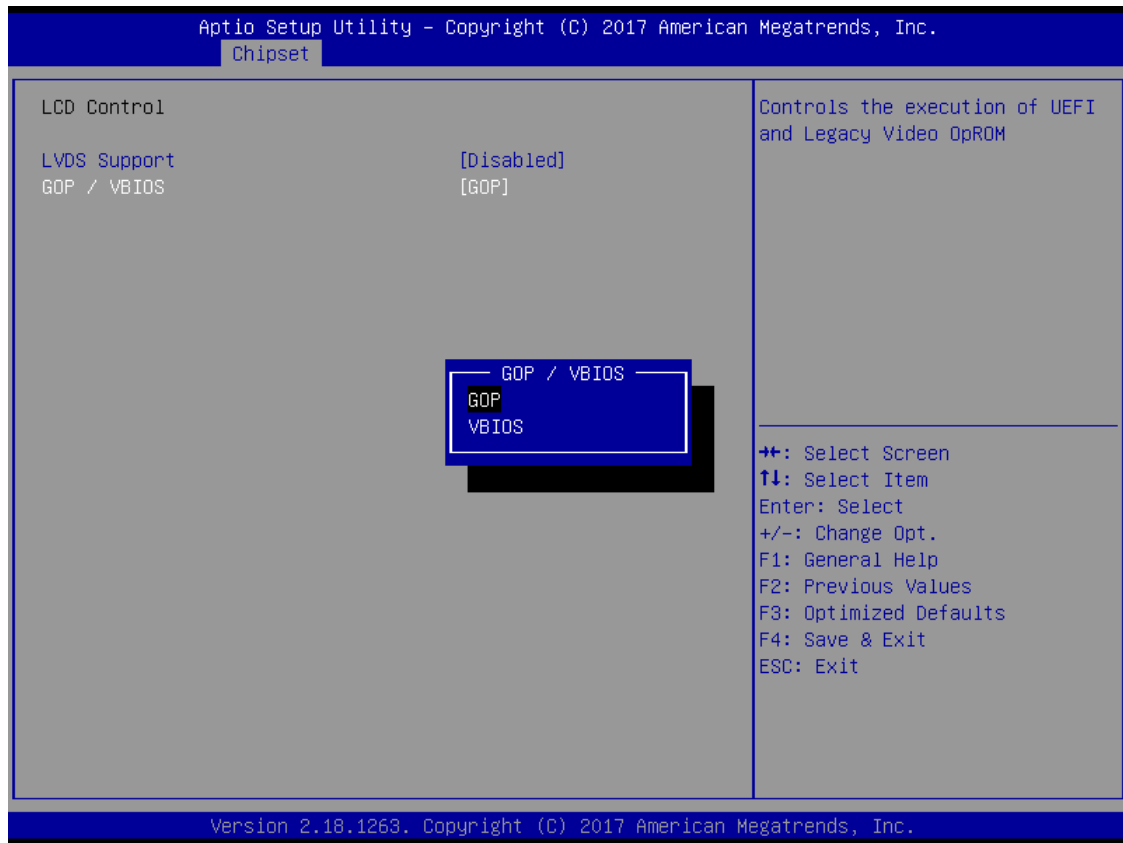

GOP / VBIOS

In order to avoid the 4K side effect, our system default is GOP mode, if customer would like to use PXE or DOS, please select VBIOS.



【Note】 : GOP mode cannot support PXE and DOS.

South Bridge

This screen shows the information of South Bridge chipset.

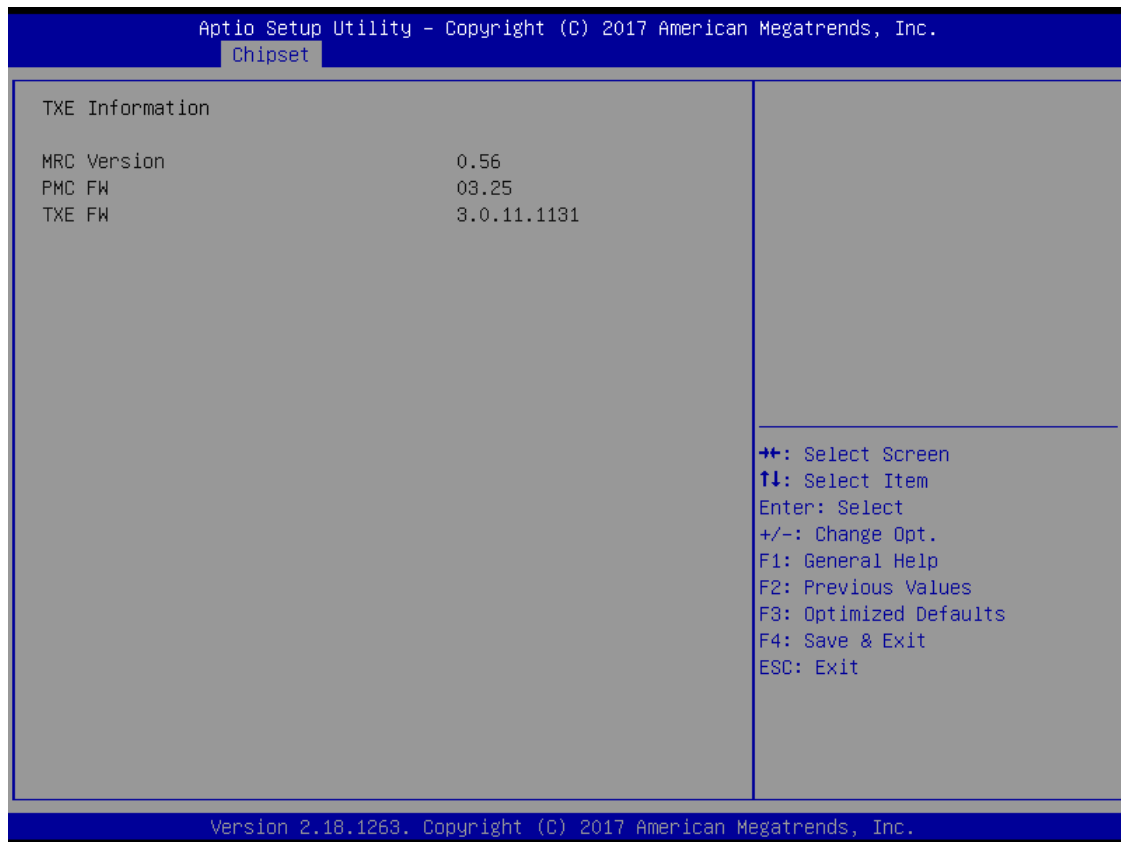

4.6 Security Menu

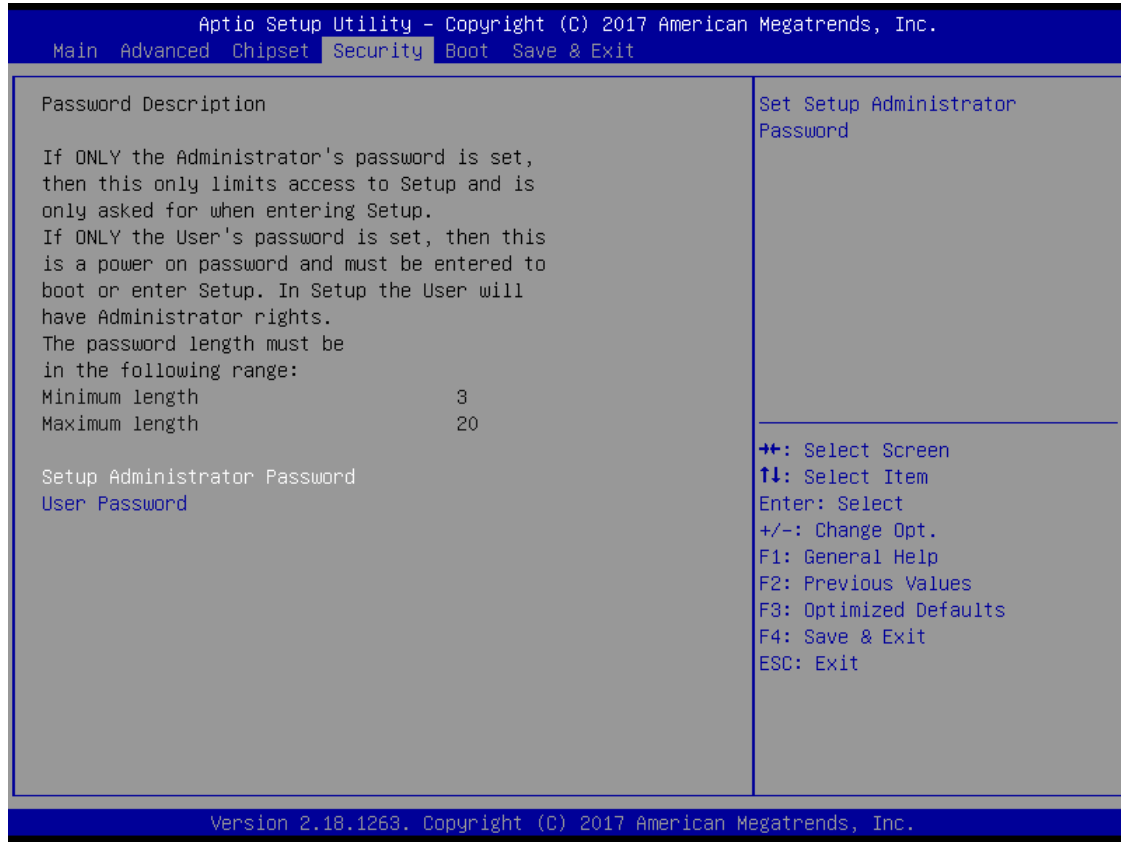

Administrator Password

This item indicates whether an administrator password has been set (installed or uninstalled).

User Password

This item indicates whether a user password has been set (installed or uninstalled).

Boot Menu

The Boot menu allows users to change boot options of the system.

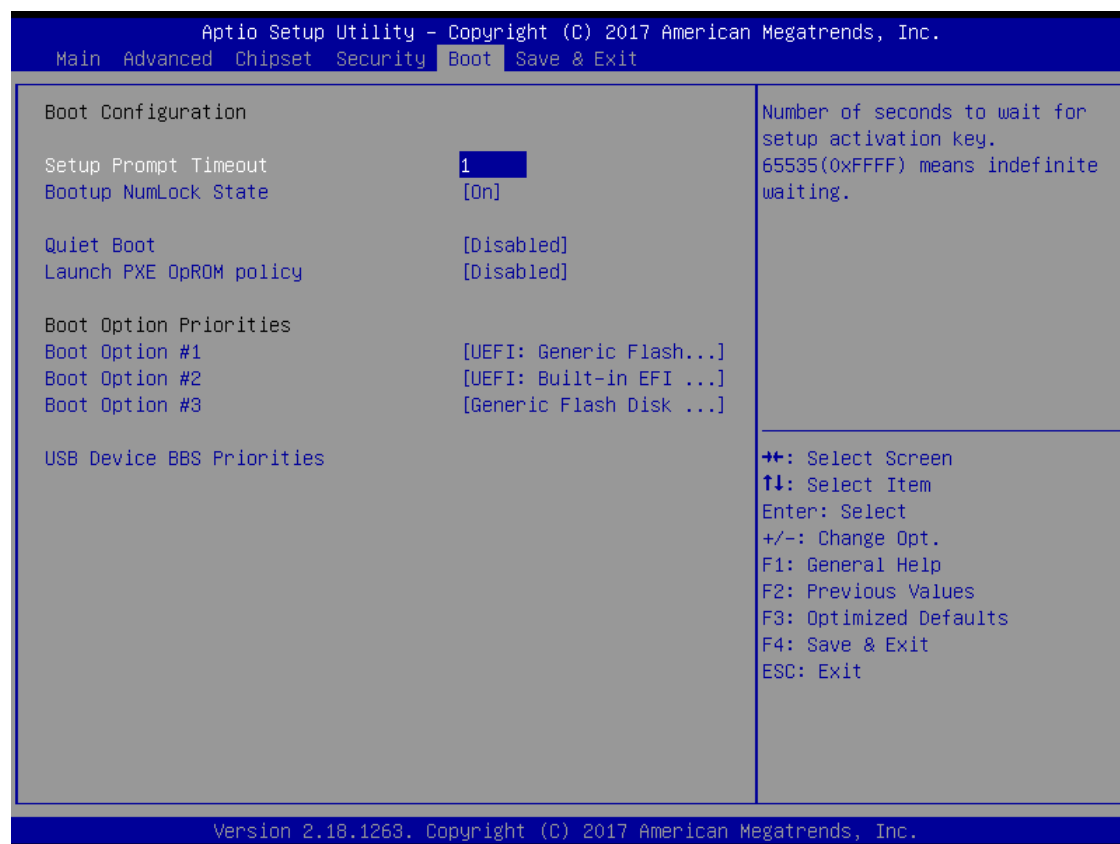

Setup Prompt Timeout

Use this item to set up number of seconds to wait for setup activation key where 65535(0xFFFF) means indefinite waiting.

Bootup NumLock State

Use this item to select the power-on state for the keyboard NumLock.

Quiet Boot

Select to display either POST output messages or a splash screen during boot-up.

Legacy PXE OpROM

Use this item to enable or disable the boot ROM function of the onboard LAN chip when the system boots up.

Boot Option Priorities

These are settings for boot priority. Specify the boot device priority sequence from the available devices.

USB Device BBS Priorities

These are settings for configuring the order for a specific device group. These options are only visible if at least one device for this group is present.

4.7 Save & Exit Menu

The Save & Exit menu allows users to load system configurations with optimal or fail-safe default values.

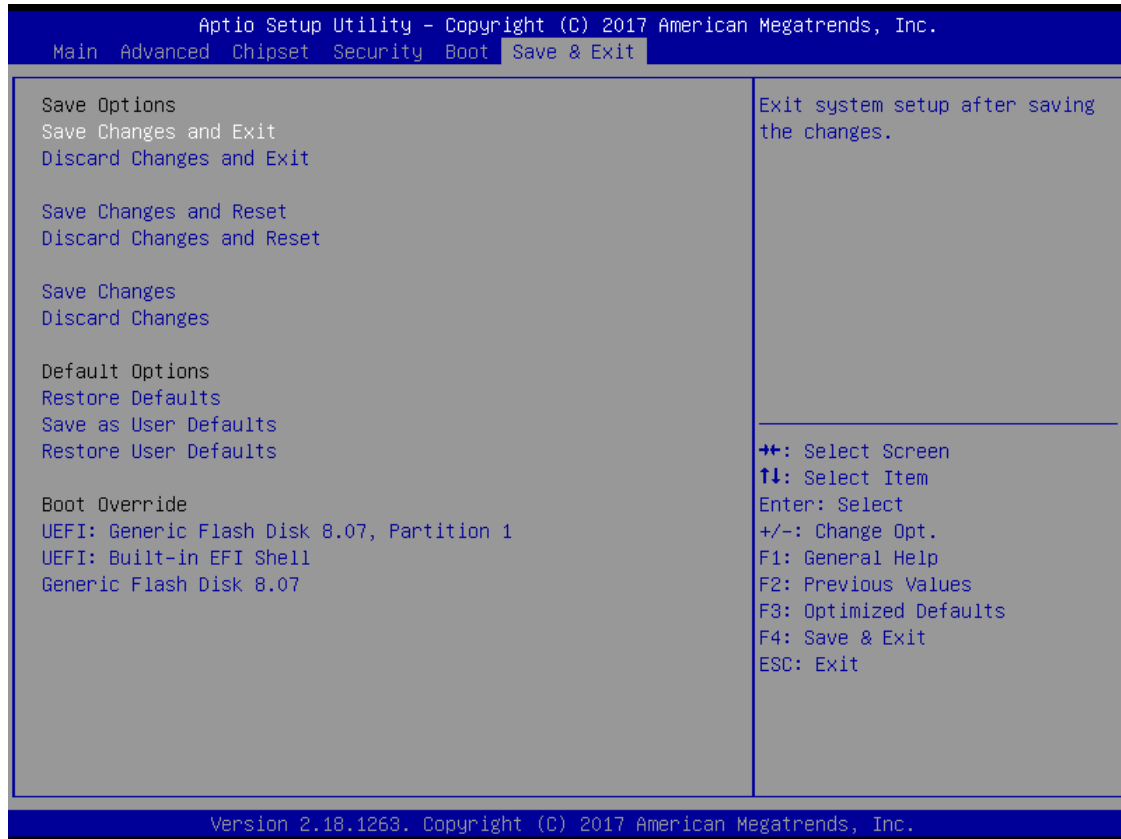

Save Changes and Exit

When users have completed the system configuration changes, select this option to leave Setup and return to Main Menu. Select Save Changes and Exit from the Save & Exit menu and press <Enter>. Select Yes to save changes and exit.

Discard Changes and Exit

Select this option to quit Setup without making any permanent changes to the system configurations and return to Main Menu. Select Discard Changes and Exit from the Save & Exit menu and press <Enter>. Select Yes to discard changes and exit.

Save Changes and Reset

When completed the system configuration changes, select this option to leave Setup and reboot the computer so the new system configurations take effect. Select Save Changes and Reset from the Save & Exit menu and press <Enter>. Select Yes to save changes and reset.

Discard Changes and Reset

Select this option to quit Setup without making any permanent changes to the system configuration and reboot the computer. Select Discard Changes and Reset from the Save & Exit menu and press <Enter>. Select Yes to discard changes and reset.

Save Changes

When completed the system configuration changes, select this option to save changes. Select Save Changes from the Save & Exit menu and press <Enter>. Select Yes to save changes.

Discard Changes

Select this option to quit Setup without making any permanent changes to the system configurations. Select Discard Changes from the Save & Exit menu and press <Enter>. Select Yes to discard changes.

Restore Defaults

It automatically sets all Setup options to a complete set of default settings when users select this option. Select Restore Defaults from the Save & Exit menu and press <Enter>.

Save as User Defaults

Select this option to save system configuration changes done so far as User Defaults. Select Save as User Defaults from the Save & Exit menu and press <Enter>.

Restore User Defaults

It automatically sets all Setup options to a complete set of User Defaults when users select this option. Select Restore User Defaults from the Save & Exit menu and press <Enter>.

Boot Override

Select a drive to immediately boot that device regardless of the current boot order.

This page is intentionally left blank.

APPENDIX A WATCHDOG TIMER

About Watchdog Timer

Software stability is major issue in most applications. Some embedded systems are not watched by human for 24 hours. It is usually too slow to wait for someone to reboot when computer hangs. The systems need to be able to reset automatically when things go wrong. The watchdog timer gives us solutions in this regard.

The watchdog timer is a counter that triggers a system to reset when it counts down to zero from a preset value. The software starts the counter with an initial value and must reset it periodically. If the counter ever reaches zero, it means the software has crashed, the system will reboot.

Sample Program

The following example enables configurations using debug tool.

Enable WDT

↓

Enable configuration:

2E 87; Un-lock super I/O

2E 87

↓

Select logic device:

2E 07

2F 08

↓

WDT device enable:

2E 30

2F 01

↓

Set timer unit:

2E F0

2F 00 ; (00: Sec; 08:Minute)

↓

Set base timer:

2E F1

2F 0A; Set reset time (where 0A (hex) = 10sec)

Disable WDT

↓

Enable configuration:

2E 87; Un-lock super I/O

2E 87

↓

Select logic device:

2E 07

2F 08

↓

WDT device disable:

2E 30

2F 00