



Simply Better Connections

ATEN NRGence™

PE5221T / PE5224TA /
PE5324T / PE5342T

21/24/42-Outlet eco PDU
User Manual

Compliance Statements

FEDERAL COMMUNICATIONS COMMISSION INTERFERENCE STATEMENT

This equipment has been tested and found to comply with the limits for a Class A digital device, pursuant to Part 15 of the FCC Rules. These limits are designed to provide reasonable protection against harmful interference when the equipment is operated in a commercial environment. This equipment generates, uses, and can radiate radio frequency energy and, if not installed and used in accordance with the instruction manual, may cause harmful interference to radio communications. Operation of this equipment in a residential area is likely to cause harmful interference in which case the user will be required to correct the interference at his own expense.

The device complies with Part 15 of the FCC Rules. Operation is subject to the following two conditions: (1) this device may not cause harmful interference, and (2) this device must accept any interference received, including interference that may cause undesired operation.

FCC Caution

Any changes or modifications not expressly approved by the party responsible for compliance could void the user's authority to operate this equipment.

Warning

Operation of this equipment in a residential environment could cause radio interference.

Achtung

Der Gebrauch dieses Geräts in Wohnumgebung kann Funkstörungen verursachen.



KCC Statement

유선 제품용 / A 급 기기 (업무용 방송 통신 기기)
이 기기는 업무용 (A 급) 전자파적합기기로서 판매자 또는 사용자는 이
점을 주의하시기 바라며, 가정 외의 지역에서 사용하는 것을 목적으로
합니다.

RoHS

This product is RoHS compliant.

PE Device Safety Notice



- ◆ Set the maximum permissible breaker protection in the building circuitry to the current rating specified on the rating plate. Observe all national regulations and safety codes as well as deviations for breakers.
- ◆ Only connect the PE Device to a grounded power outlet or a grounded system!
- ◆ Make sure that the total current input of the connected systems does not exceed the current rating specified on the rating plate of the PE Device.
- ◆ There is a risk of explosion if the battery is replaced with an incorrect type. Dispose of used batteries according to the relevant instructions.

About This Manual

This User Manual is provided to help you get the most from your eco PDU system. It covers all aspects of installation, configuration and operation. An overview of the information found in the manual is provided below.

Chapter 1, *Introduction*, introduces you to the eco PDU system. Its purpose, features and benefits are presented, and its front and back panel components are described.

Chapter 2, *Hardware Setup*, provides step-by-step instructions for setting up your installation.

Chapter 3, *Basic Operation and First Time Setup*, explains the procedures that the Administrator employs to set up the eco PDU network environment, and change the default username and password.

Chapter 4, *Browser Operation*, describes how to log in to the eco PDU with an Internet browser, and explains the layout and components of the eco PDU's user interface.

An Appendix, provides specifications and other technical information regarding the eco PDU.

Conventions

This manual uses the following conventions:

- | | |
|---|--|
| Monospaced | Indicates text that you should key in. |
| [] | Indicates keys you should press. For example, [Enter] means to press the Enter key. If keys need to be chorded, they appear together in the same bracket with a plus sign between them: [Ctrl+Alt]. |
| 1. | Numbered lists represent procedures with sequential steps. |
| ◆ | Bullet lists provide information, but do not involve sequential steps. |
| > | Indicates selecting the option (on a menu or dialog box, for example), that comes next. For example, Start > Run means to open the <i>Start</i> menu, and then select <i>Run</i> . |
|  | Indicates critical information. |

Package Contents

The eco PDU PE Series package consists of:

- 1 PE5221T / PE5224TA / PE5324TA / PE5342TB / PE5342TG Power Distribution Unit
- 1 power cord (PE5221T / PE5224TA only)
- 1 mounting kit
- 1 user instructions*

Check to make sure that all of the components are present and in good order. If anything is missing, or was damaged in shipping, contact your dealer.

Read this manual thoroughly and follow the installation and operation procedures carefully to prevent any damage to the switch or to any other devices on the eco PDU installation.

* Features may have been added to the eco PDU since this manual was published. Please visit our website to download the most up-to-date version.

Product Information

For information about all ATEN products and how they can help you connect without limits, visit ATEN on the Web or contact an ATEN Authorized Reseller. Visit ATEN on the Web for a list of locations and telephone numbers:

International	http://www.aten.com
North America	http://www.aten-usa.com

User Information

Online Registration

Be sure to register your product at our online support center:

International	http://eservice.aten.com
---------------	---

Telephone Support

For telephone support, call this number:

International	886-2-8692-6959
China	86-10-5255-0110
Japan	81-3-5615-5811
Korea	82-2-467-6789
North America	1-888-999-ATEN ext 4988
United Kingdom	44-8-4481-58923

User Notice

All information, documentation, and specifications contained in this manual are subject to change without prior notification by the manufacturer. The manufacturer makes no representations or warranties, either expressed or implied, with respect to the contents hereof and specifically disclaims any warranties as to merchantability or fitness for any particular purpose. Any of the manufacturer's software described in this manual is sold or licensed *as is*. Should the programs prove defective following their purchase, the buyer (and not the manufacturer, its distributor, or its dealer), assumes the entire cost of all necessary servicing, repair and any incidental or consequential damages resulting from any defect in the software.

The manufacturer of this system is not responsible for any radio and/or TV interference caused by unauthorized modifications to this device. It is the responsibility of the user to correct such interference.

The manufacturer is not responsible for any damage incurred in the operation of this system if the correct operational voltage setting was not selected prior to operation. **PLEASE VERIFY THAT THE VOLTAGE SETTING IS CORRECT BEFORE USE.**

If any bodily injury or property damage with respect to operation of the product results from users not having installed the product in accordance with the instructions provided in the product's user manual, or the product is used in an environment with a current load over the designed specifications of the product, ATEN is not liable for any loss or damage.

Contents

Compliance Statements	ii
About This Manual	iv
Conventions	iv
Package Contents	v
Product Information	vi
User Information	vi
Online Registration	vi
Telephone Support	vi
User Notice	vii
Contents	viii

Chapter 1.

Introduction

Overview	1
Comparison Chart	3
Features	4
Power Distribution	4
Remote Access	4
Operation	4
Management	4
Security	5
eco Sensors Energy Management Software*	5
Requirements	6
Optional Accessories	7
Sensors	7
Cable Holders	7
Components	8
PE5221T Front View	8
PE5224TA Front View	10
PE5324TA Front View	12
PE5342TB Front View	14
PE5342TG Front View	16
Readout Section	18

Chapter 2.

Hardware Setup

Before You Begin	19
Rack Mounting	19
PDU Placement	20
Installation	21
Securing the Cables / Plugs	23
Securing the Sensors	24

Chapter 3.

Basic Operation and First Time Setup

Operation Methods	25
Browser	25
eco Sensors	25
SNMP	25
First Time Setup	26
Network Configuration	27
Changing the Administrator Login	28
Moving On	28

Chapter 4.

Browser Operation

Logging In	29
The eco PDU Main Page	30
Page Components	31
Energy	32
Connections	32
Configuration	35
User	36
Administrator Information	36
User Information	37
Log	38
The System Log Event List	38
Notification Settings	39
Setup	40
Device Configuration	40
Date/Time	46
Security	48
Login Failures	48
Working Mode	48
Session Timeout	48
Account Policy	49
Login String / IP Filter / Mac Filter	50
Authentication & Authorization	53
Private Certificate	54
PDU	56
Firmware File	56
Backup/Restore	58
Safety Instructions	59
General	59
Rack Mounting	62
The eco PDU's Main Power Cord	62
Securing the Power Cables	62
Technical Support	63
International	63

North America	63
IP Address Determination	64
Specifications	66
PE5221T(B)	66
PE5221T(G)	67
PE5221T(J)	68
PE5224TA	70
PE5224TA - Japan	71
PE5324TA	72
PE5324TA - Japan	73
PE5342TB	74
PE5342TB - Japan	75
PE5342TG	76
Administrator Login Failure	77
Limited Warranty	78

Chapter 1

Introduction

Overview

As part of its NRGence line, ATEN has developed a new generation of green energy power distribution units (PDUs) to effectively increase rack space and the efficiency of data center power usage. The NRGence PE5221T / PE5224TA / PE5324TA / PE5342TB / PE5342TG eco PDUs are thin form factor intelligent PDUs that contain 21/24/42 AC outlets and are available in various IEC or NEMA socket configurations.

Thin form factor PDUs have a smaller 56 mm width to fit tight into server racks providing more space for cooling and maintenance. The smaller design leaves 8% more space in the server rack to increase air flow and cool IT equipment more efficiently. For full racks this means faster maintenance with easier access to equipment installed behind PDUs.

They provide secure, centralized, intelligent, power monitoring at the PDU or bank level with the ability to monitor the health of the data center's environment via sensors*. The basic characteristics of each model are shown in the table on page 3.

The NRGence eco PDUs offer real-time power measurement and threshold alerts – allowing you to monitor the PDU's power status, bank status and circuit breakers*, either at the PDU device or from practically any location via a TCP/IP connection*.

Installation and operation is fast and easy: plugging cables into their appropriate ports and user-friendly browser-based configuration and management is all that is entailed. Since the eco PDU firmware is upgradeable over the Net, you can stay current with the latest functionality improvements simply by downloading updates from our website as they become available.

NRGence eco PDU supports any 3rd party V1, V2, V3 SNMP Manager Software and NRGence eco Sensors (eco PDU Manager Software). eco Sensors provides you with an easy method for managing multiple devices, offering an intuitive and user-friendly Graphical User Interface that allows you to configure a PDU device and monitor power status of the equipment connected to it.

The thin form factor series of ATEN PDUs have a circuit breaker alert that can sound an alarm and send SNMP trap or e-mail alerts when a trip occurs. This

feature provides a faster response time to recover servers and other devices when a circuit overload causes a loss of power.

With its advanced security features and ease of operation, the eco PDU is the most convenient, most reliable, and most cost effective way to remotely monitor power and allocate power resources in the most efficient way possible.

-
- Note:**
1. Sensors are optional accessories. A sensor-enabled installation is required to generate a more complete energy-efficient data and chart. Higher sensor installation density is helpful to generate more accurate data. See *Optional Accessories*, page 7, for further information.
 2. Circuit breaker monitoring is only available on models with 30/32 amps.
 3. eco PDUs are primarily designed for access via Intranets; extra network security protection is suggested for Internet access usage.
-

Comparison Chart

Model	Inlet / Cord	Outlets		Metering Level	Amps	
					Per Port	Total
PE5221T	IEC 60320 20	21	18 x IEC320 C13 3 x IEC320 C19	PDU / Bank	10A (Max), 16A (Max)	16A (Max)
	NEMA 6-20p	21		PDU / Bank	15A (Max) 12A (UL de-rated), 20A (Max) 16A (UL de-rated)	20A (Max), 16A (UL de-rated)
	NEMA L6-20p	21		PDU / Bank	15A (Max) 12A (UL de-rated), 20A (Max) 16A (UL de-rated)	20A (Max), 16A (UL de-rated)
PE5224TA	NEMA 5-20P	24	24 x NEMA 5-20R	PDU / Bank	20A (Max), 16A(UL de-rated)	20A (Max), 16A (UL de-rated)
PE5324TA	NEMA L5-30P	24	24 x NEMA 5-20R	PDU / Bank	15A (Max), 12A (UL de-rated)	30A (Max), 24A (UL de-rated)
PE5342TB	NEMA L6-30P	42	36 x IEC320 C13 6 x IEC320 C19	PDU / Bank	Per C13 Duplex Receptacles: 15A (Max), 12A (UL de-rated); Per C19 outlet: 15A (Max), 12A (UL de-rated)	30A (Max), 24A (UL de-rated)
PE5342TG	IEC 60309 32A	42	36 x IEC320 C13 6 x IEC320 C19	PDU / Bank	Per C13 Duplex Receptacles: 10A; Per C19 outlet: 16A	32A (Max)

Note: For the complete specifications of individual models, please reference *Specifications*, page 66.

Features

Power Distribution

- ◆ Thin Form Factor design with 56 mm width
- ◆ Space saving 0U rack mount with rear mounting
- ◆ IEC or NEMA outlet models
- ◆ 3 digit 7-segment front panel LED shows PDU/Bank current/IP address
- ◆ Remote users can monitor PDU / Bank status via web pages on their browsers
- ◆ 2 16A slim breakers (PE5342T and PE5324T models only)
- ◆ Safe shutdown support
- ◆ Separate power for the unit's own power and its power outlets. The user interface is still accessible even when an overload condition trips the devices' circuit breaker
- ◆ Supports button mount on the rear of the PDU for easy installation

Remote Access

- ◆ Remote power control via TCP/IP and a built in 10/100 Ethernet port
- ◆ Network Protocols: TCP/IP, UDP, HTTP, HTTPS, SSL, SMTP, DHCP, NTP, DNS, auto sense, Ping
- ◆ eco PDU Power Management software – eco Sensors
- ◆ Supports SNMP Manager V1, V2 & V3

Operation

- ◆ Supports multiple power control methods – Wake on LAN, System after AC Back, Kill the Power
- ◆ Easy setup and operation via a browser-based user interface
- ◆ RTC support to keep the timer running during times of no power.
- ◆ Up to 8 user accounts and 1 administrator account.

Management

- ◆ Power status measurement at the PDU / Bank level*
- ◆ LED indicators for PDU and Bank current and IP address at the PDU

- ◆ Real-time aggregate current, voltage, and power and power dissipation displayed in a browser-based UI for monitoring at the PDU level and at the bank level*
- ◆ Environment monitoring – supports external temperature / humidity / differential pressure sensors for rack environment monitoring
- ◆ Circuit breaker alert sounds an alarm and sends SNMP trap or e-mail alerts when a circuit breaker trips*
- ◆ Current and voltage threshold setting
- ◆ Naming support for outlets
- ◆ User outlet access assignment on an outlet-by-outlet basis.
- ◆ Event logging and syslog support
- ◆ Upgradeable firmware
- ◆ Multi-language support: English, Traditional Chinese, Simplified Chinese, Japanese, German, Italian, Spanish, French, Russian, Korean, Portuguese.

Note: Circuit breaker and bank level monitoring only available on 30A/32A models.

Security

- ◆ Two-level password security
- ◆ Strong security features include strong password protection and advanced encryption technologies – 128 bit SSL
- ◆ Remote authentication support: RADIUS

eco Sensors Energy Management Software*

- ◆ Automatic discovery of all PE devices within the same Internet
- ◆ Remote real-time power measurement and monitoring
- ◆ Real-time environment sensor monitoring
- ◆ Plotting/monitoring of all PE devices
- ◆ Exceed threshold alert through SMTP and System log
- ◆ Power Analysis report

Note: eco Sensors is designed to work with NRGence PDUs and is bundled with all PE series packages.

Requirements

- ◆ Browsers accessing the eco PDU unit must support SSL 128 bit encryption.
- ◆ For cold booting of attached computers, the computer's BIOS must support *Wake on LAN* or *System after AC Back*.
- ◆ For Safe Shutdown:
 - ◆ The computer must be running Windows (Windows 2000 or higher) or Linux.
 - ◆ The *Safe Shutdown* program (available by download from our website or on the software CD included), must be installed and running on the computer.

Optional Accessories

Sensors

Sensors are optional accessories. You can use the eco PDU unit without sensors. However, if you want to have complete energy management of an instrumented data center with the use of the eco PDU, you would need to use eco Sensors software and install 4 sensors for each of the racks to generate a complete energy-efficient data and chart. Higher sensor installation density is helpful to generate more accurate data. 24/40 -port models have 2 sensor ports. In this case, Sensor 1 needs to be installed at the intake of the rack and sensor 2 needs to be placed at the exhaust of IT equipment of the rack. A sensor-enabled installation is required to generate a more complete energy-efficient data and chart. Higher sensor installation density is helpful to generate more accurate data. Available sensors are show in the table, below:

Sensor	Part Number
Temperature	EA1140
Temperature / Humidity	EA1240
Differential Pressure / Temperature	EA1340

Sensor Management

Sensors can be managed via the eco PDU's built-in graphical user interface (GUI) or with the NRGence eco Sensors software that can be downloaded from the ATEN website. The download link can be found on the software CD provided with the eco PDU package.

Cable Holders

Cable holders are optional accessories. For added safety, use ATEN Lok-U-Plug cable holders and EZ-Lok Plug Connectors to secure the cables from your attached devices in place on the eco PDU unit. Use only the ATEN Lok-U-Plug cable holders and EZ-Lok Plug Connectors that have been specifically designed to work with the eco PDU. Using any other kind of cable securing device could be highly dangerous.

Part Number	Description
2X-EA07	Lok-U-Plug Cable Holder (10 pcs)
2X-EA08	Lok-U-Plug Installation Tool (4 pcs)
2X-EA10	C14 EZ-Lok Plug Connector
2X-EA11	C20 EZ-Lok Plug Connector

Components

PE5221T Front View

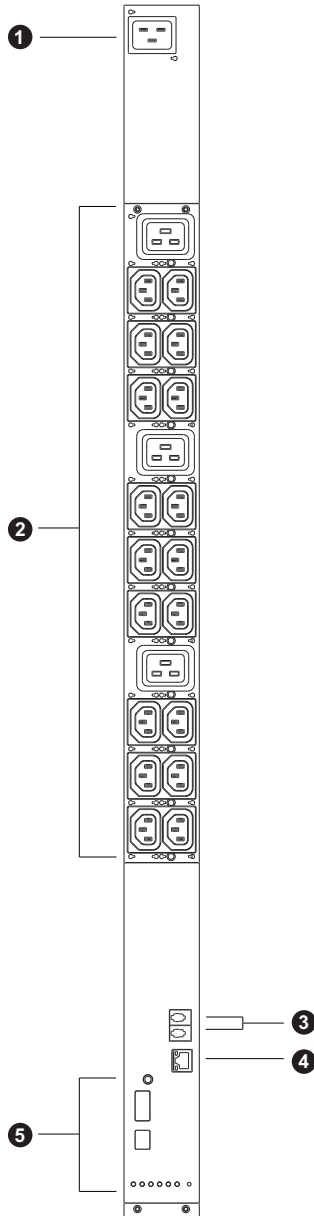

No.	Item	Description
1	power inlet	The power cord that connects the unit to an AC power source plugs into this IEC 60320 C20 socket.
2	power outlets*	21 in total (18 x IEC320 C13 + 3 x IEC320 C19)
3	sensor ports	External sensors plug into these two RJ-11 ports.
4	LAN port and LEDs	<p>The cable that connects the eco PDU to the LAN plugs in here. The link and LAN LEDs are built into the LAN port:</p> <p>Link: Lights green to indicate that a connection via the eco PDU's RJ-45 Ethernet port has been established. Flashes to indicate data is being transmitted.</p> <p>LAN: Lights orange to indicate 10 Mbps data transmission speed. The LED lights green to indicate 100 Mbps data transmission speed.</p>
5	readout section, LEDs and reset button	Details of this section are provided on page 18.

Note: Holes for ATEN Lok-U-Plug cable holders are located around the outlets. See *Securing the Cables / Plugs*, page 23, for further information.

PE5224TA Front View

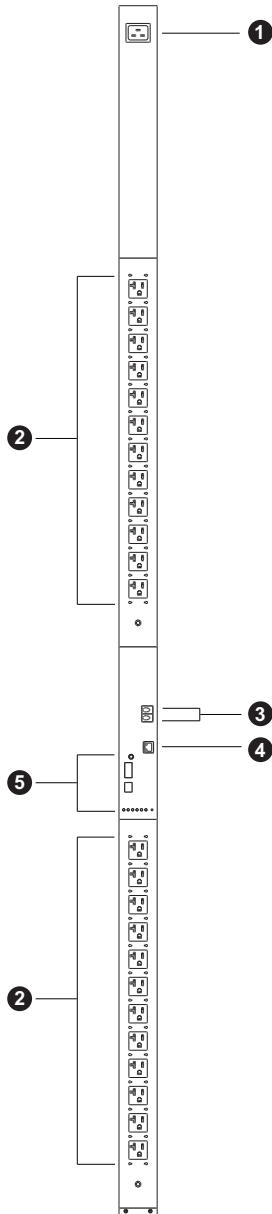

No.	Item	Description
1	power inlet	The power cord that connects the unit to an AC power source plugs into this IEC 60320 C20 socket.
2	power outlets*	24 x NEMA 5-20R
3	sensor ports	External sensors plug into these two RJ-11 ports.
4	LAN port and LEDs	<p>The cable that connects the eco PDU to the LAN plugs in here. The link and LAN LEDs are built into the LAN port:</p> <p>Link: Lights green to indicate that a connection via the eco PDU's RJ-45 Ethernet port has been established. Flashes to indicate data is being transmitted.</p> <p>LAN: Lights orange to indicate 10 Mbps data transmission speed. The LED lights green to indicate 100 Mbps data transmission speed.</p>
5	readout section, LEDs and reset button	Details of this section are provided on page 18.

Note: Holes for ATEN Lok-U-Plug cable holders are located around the outlets. See *Securing the Cables / Plugs*, page 23, for further information.

PE5324TA Front View

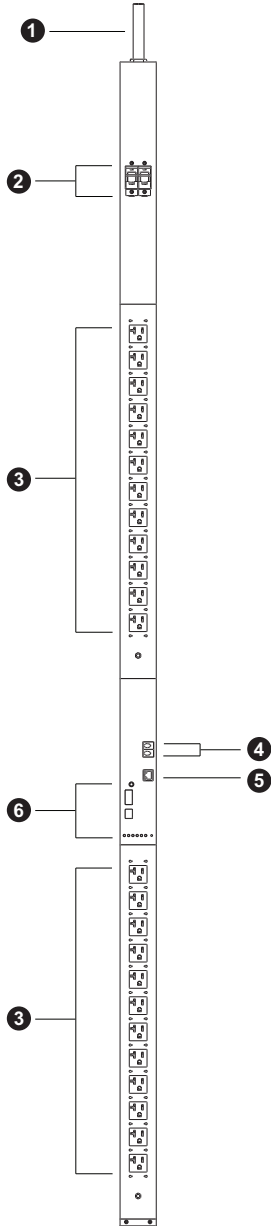

No.	Item	Description
1	power cord	This is the power cord that connects the unit to an AC power source via NEMA L5-30P plug.
2	circuit breakers (Bank 1 and Bank 2)	2 x 16A slim breakers. As a safety measure, if there is an overcurrent situation regarding the device's power, the circuit breakers will trip. Push the switch back to recover normal operation.
3	power outlets*	24 x NEMA 5-20R
4	sensor ports	External sensors plug into these two RJ-11 ports.
5	LAN port and LEDs	<p>The cable that connects the eco PDU to the LAN plugs in here. The link and LAN LEDs are built into the LAN port:</p> <p>Link: Lights green to indicate that a connection via the eco PDU's RJ-45 Ethernet port has been established. Flashes to indicate data is being transmitted.</p> <p>LAN: Lights orange to indicate 10 Mbps data transmission speed. The LED lights green to indicate 100 Mbps data transmission speed.</p>
6	readout section, LEDs and reset button	Details of this section are provided on page 18.

Note: Holes for ATEN Lok-U-Plug cable holders are located around the outlets. See *Securing the Cables / Plugs*, page 23, for further information.

PE5342TB Front View

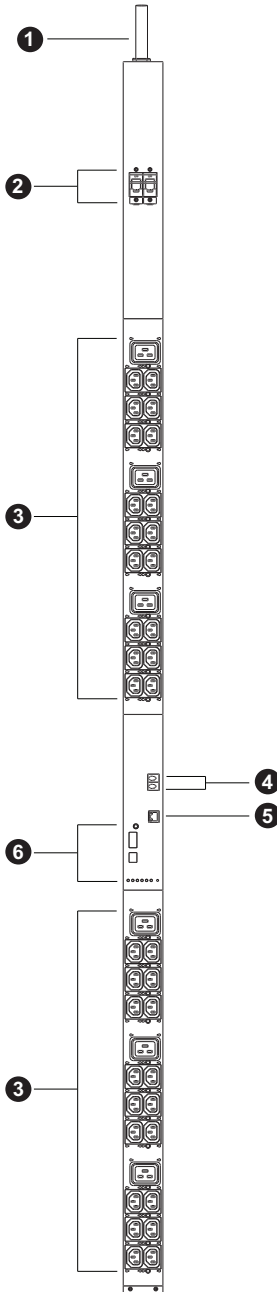

No.	Item	Description
1	power cord	This is the power cord that connects the unit to an AC power source via NEMA L6-30P plug.
2	circuit breakers (Bank 1 and Bank 2)	2 x 16A slim breakers. As a safety measure, if there is an overcurrent situation regarding the device's power, the circuit breakers will trip. Push the switch back to recover normal operation.
3	power outlets*	42 in total (36 x IEC320 C13 + 6 x IEC320 C19)
4	sensor ports	External sensors plug into these two RJ-11 ports.
5	LAN port and LEDs	<p>The cable that connects the eco PDU to the LAN plugs in here. The link and LAN LEDs are built into the LAN port:</p> <p>Link: Lights green to indicate that a connection via the eco PDU's RJ-45 Ethernet port has been established. Flashes to indicate data is being transmitted.</p> <p>LAN: Lights orange to indicate 10 Mbps data transmission speed. The LED lights green to indicate 100 Mbps data transmission speed.</p>
6	readout section, LEDs and reset button	Details of this section are provided on page 18.

Note: Holes for ATEN Lok-U-Plug cable holders are located around the sockets. See *Securing the Cables / Plugs*, page 23, for further information.

PE5342TG Front View

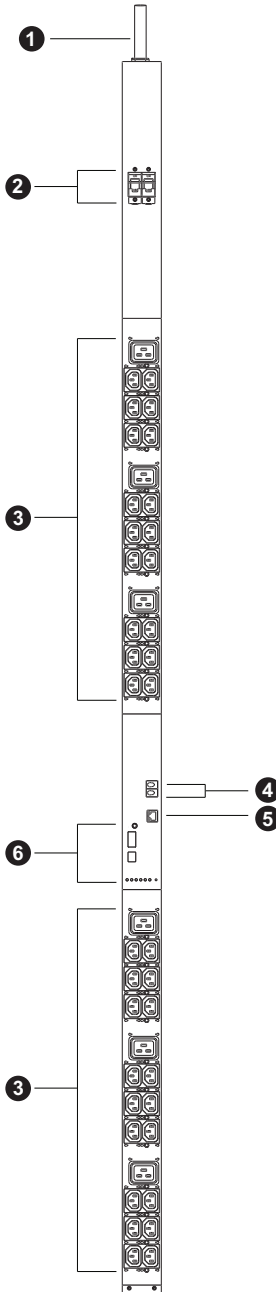

No.	Item	Description
1	power cord	This is the power cord that connects the unit to an AC power source via IEC 60309 32A plug.
2	circuit breakers (Bank 1 and Bank 2)	2 x 16A slim breakers. As a safety measure, if there is an overcurrent situation regarding the device's power, the circuit breakers will trip. Push the switch back to recover normal operation.
3	power outlets*	42 in Total (36 x IEC320 C13 + 6 x IEC320 C19)
4	sensor ports	External sensors plug into these two RJ-11 ports.
5	LAN port and LEDs	<p>The cable that connects the eco PDU to the LAN plugs in here. The link and LAN LEDs are built into the LAN port:</p> <p>Link: Lights green to indicate that a connection via the eco PDU's RJ-45 Ethernet port has been established. Flashes to indicate data is being transmitted.</p> <p>LAN: Lights orange to indicate 10 Mbps data transmission speed. The LED lights green to indicate 100 Mbps data transmission speed.</p>
6	readout section, LEDs and reset button	Details of this section are provided on page 18.

Note: Holes for ATEN Lok-U-Plug cable holders are located around the sockets. See *Securing the Cables / Plugs*, page 23, for further information.

Readout Section

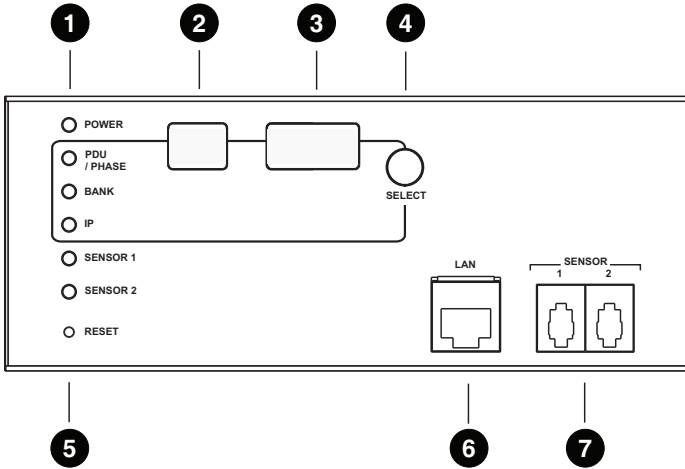

No.	Item	Description
1	status LEDs	Power: Lights when the unit is powered on and ready to operate.
2	ID section	<ul style="list-style-type: none"> ◆ The ID of the selected PDU/ Phase / Bank / IP appears in the LED display window. ◆ When the PDU/Phase LED is lit, use the selection button to cycle through the items. ◆ When the Bank LED is lit, use the selection button to toggle between Bank 1 and Bank 2
3	readout section	<ul style="list-style-type: none"> ◆ When PDU/ Phase / Bank / IP is selected, readouts for Current and IP appear in the display. ◆ Press the button next to the LED display window to cycle the selection between the items. ◆ When a sensor is plugged in, the sensor LED lights up.
4	selection pushbutton	Press this button to cycle the selection through the items; the LEDs next to the items indicate which one the displays relate to.
5	reset button	<p>This button is semi-recessed and must be pushed with a thin object, such as the end of a paper clip.</p> <ul style="list-style-type: none"> ◆ Press and release to reboot the device. ◆ Press and hold for more than three seconds to reset the eco PDU to its factory default settings
6	LAN port	The cable that connects the unit to the Internet, LAN, or WAN plugs in here.
7	sensor ports	External sensors plug into these two RJ-11 ports. See <i>Optional Accessories</i> , page 7, and <i>Securing the Sensors</i> , page 24.

Chapter 2

Hardware Setup

Before You Begin



1. Important safety information regarding the placement of this device is provided on page 59. Please review it before proceeding.
2. Make sure that power to all the devices you will be connecting have been turned off. You must unplug the power cords of any computers that have the Keyboard Power On function.

Rack Mounting

The eco PDU can be mounted in a 0U configuration on the side of a rack. To rack mount the device, use the rack mount brackets that came with your device. The brackets can be mounted either near the top and bottom of the back panel, or the top and bottom ends of the device, as shown in the diagram below:

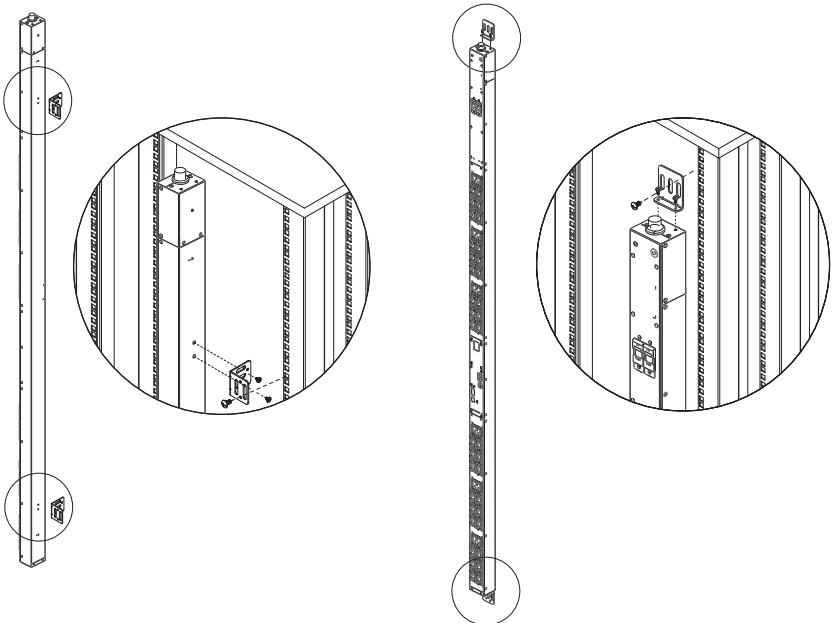

PDU Placement

For safety reasons the eco PDU should not be installed with the power sockets facing directly up or down, and thus should only be installed with the power sockets facing out from a vertical position as shown below:

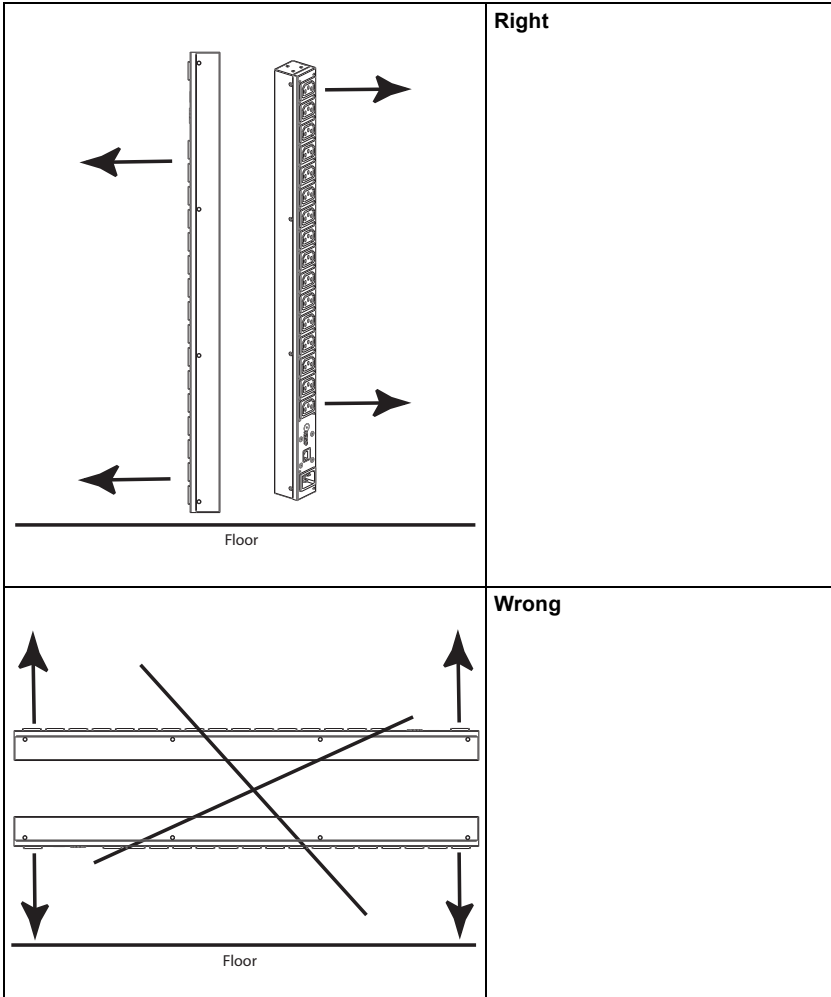

Installation

To set up your eco PDU installation, refer to the installation diagram on the next page (the numbers in the diagram correspond to the numbered steps), and do the following:

1. For each device you want to connect, use its power cable to connect from the device's AC socket to any available outlet on the eco PDU. Use ATEN Lok-U-Plug cable holders to secure them.

Note: See *Securing the Cables / Plugs*, page 23, for details.

2. Plug the cable that connects the eco PDU to the LAN into the eco PDU's LAN port.
3. If you are using sensors in your eco PDU installation, connect them to the sensor ports on the unit's front panel.

Note: Sensors are optional. Please see *Optional Accessories*, page 7, and the detailed sensor installation diagrams later in this chapter for further information.

4. Connect the eco PDU's power cord to an AC power source.

Note: We strongly advise that you do not plug the eco PDU into a multi socket extension cord, since it may not receive enough amperage to operate correctly.

Once you have finished these installation steps, you can turn on the eco PDU and the connected devices.

Note: We strongly recommend using cable ties and cable bars to safely and securely route the cables attached to the front of the unit.

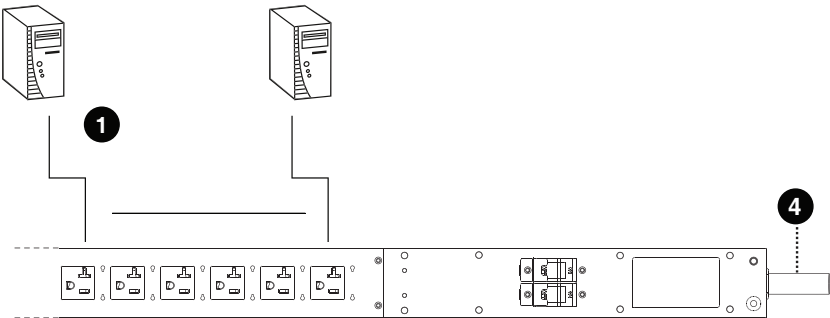
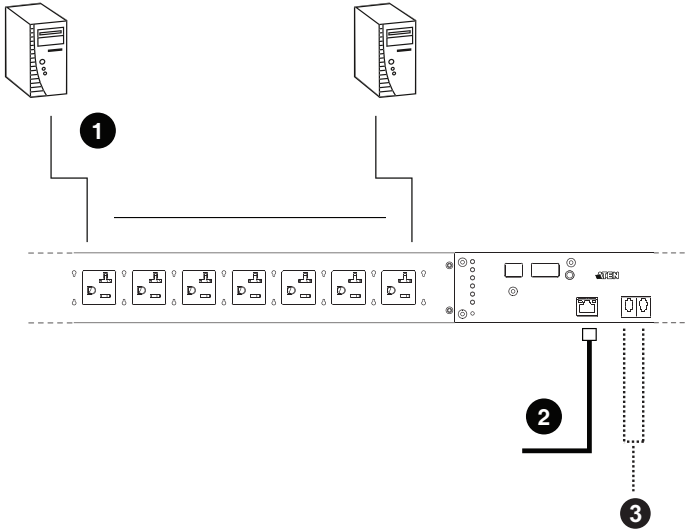

Securing the Cables / Plugs

For added safety, use ATEN Lok-U-Plug cable holders or EZ-Lok Plug Connectors to secure the cables from your attached devices in place on the eco PDU unit. Secure the cable holders using the specially designed holes around the individual power outlets, as shown below:

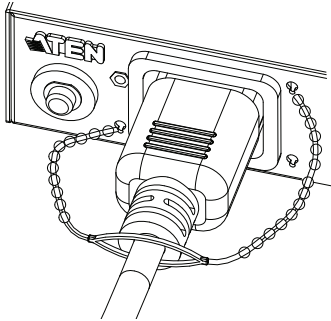

For EZ-Lok Plug Connectors fit the plug connector onto the input end of a C14 or C20 plug until it clicks in place and then connect the plug with the EZ-Lok Connector into the PDU by sliding it directly over and straight into the outlet.

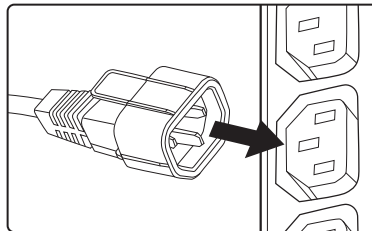
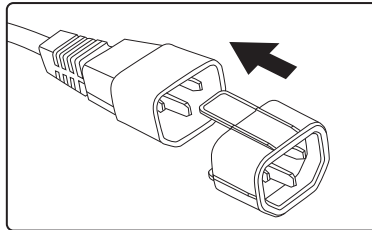

-
- Note:** 1. Cable holders are an optional accessory. See *Cable Holders*, page 7.
2. Use only the ATEN Lok-U-Plug cable holders or EZ-Lok Plugs that have been specifically designed to work with the eco PDU. Using any other kind of cable securing device could be highly dangerous.
-

Securing the Sensors

Connect the sensors to the eco PDU's front panel sensor ports and secure them using sensor mounts, tie wraps, and adhesive cable tie holders. If you use a tie wrap to secure the sensor, tighten the tie wrap over the recessed channel on the sensor, as shown in the following diagram:

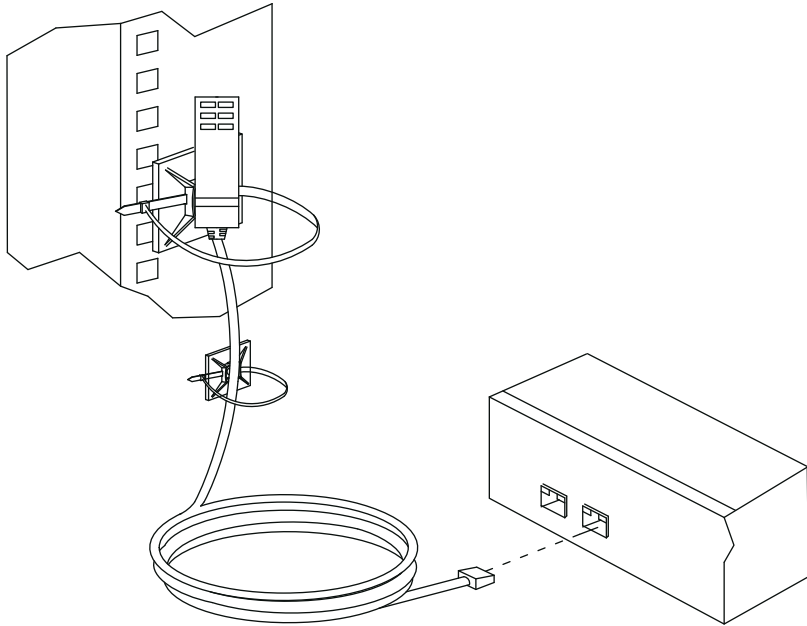

-
- Note:**
1. The sensors shown in the above diagram are for reference purposes only. The sensors for the eco PDU may look slightly different.
 2. Depending on the model and type of sensor, sensor mounts, tie wraps, and adhesive cable tie holders may or may not be provided in the package.
-

Chapter 3

Basic Operation and First Time Setup

Operation Methods

NRGence eco PDU models provide three methods to access and manage your installation: Browser, eco Sensors (eco PDU Management Software), and SNMP.

Note: The following sections of this chapter contain information concerning Browser operation. For eco Sensors operation, please reference the separate eco Sensors User Manual. The eco Sensors software and User Manual can be downloaded from the ATEN website.

Browser

NRGence s can be accessed and controlled via any supported Internet browser from any platform. See *First Time Setup*, page 26, and the following sections in this chapter, for full details.

eco Sensors

All eco PDUs support eco Sensors (eco PDU Manager Software). NRGence eco Sensors provides you with an easy method for managing multiple devices, offering an intuitive and user-friendly Graphical User Interface that allows you to configure a PDU device and monitor power status of the equipment connected to it. NRGence eco Sensors can be downloaded from the ATEN website, along with a separate eco Sensors User Manual.

SNMP

NRGence eco PDUs support any 3rd party V1, V2, V3 SNMP Manager Software. SNMP Management Information Database (MIB) files for the eco PDU device can be found on the software CD provided with the eco PDU package.

First Time Setup

Once the eco PDU installation has been cabled up, the next task the Administrator needs to perform involve configuring the network parameters, changing the default Super Administrator login settings, and adding users.

The way to accomplish this is to log in over the network with a browser.

- Note:** 1. Since this is the first time you are logging in, use the default Username: *administrator*; and the default Password: *password*. For security purposes we recommend changing them to something unique (see *Changing the Administrator Login*, page 28).
2. For remote methods of getting logged in to the network, see *IP Address Determination*, page 64.

After you successfully log in, the eco PDU Energy/Connections page appears:

The screenshot shows the NRG@force PE5342TB web interface. The top navigation bar includes 'Energy', 'User', 'Log', 'Setup', and 'PDU' tabs. The 'Connections' section is active, showing a 'Configuration' view with 'Help' and 'Logout' buttons. The main content area is divided into two sections: 'PDU Status' and 'Bank Status'.

PDU Status Table:

PDU Name	Measurement	Value	Min Threshold	Max Threshold
PE5342TB	Aggregate current	0.00 A		
	Voltage	115.83 V		
	Power	0.0000 W		
	Aggregate power dissipation	0.0000 KWH		
	Voltage frequency	59.93 HZ		
	Sensor1	Temperature	N/A	
Sensor2	Humidity	N/A		
	Pressure	N/A		
	Temperature	N/A		
	Humidity	N/A		
	Pressure	N/A		

Bank Status Table:

Bank	Bank Name	Measurement	Value	Min Threshold	Max Threshold
001		Current	0.00 A		
		Voltage	115.83 V		
		Power	0.0000 W		
		Power Dissipation	0.0000 KWH		
		Breaker	ON		
		Power factor	1.00		
002		Current	0.00 A		
		Voltage	115.83 V		
		Power	0.0000 W		
		Power Dissipation	0.0000 KWH		
		Breaker	ON		
		Power factor	1.00		

Note: Operation details are discussed in *Energy*, page 32, in the next chapter. For further setup information, continue with this chapter

Network Configuration

To set up the network, do the following:

1. Click the **Setup** tab.
2. The interface displays the **Device Configuration** page. A screen similar to the one below appears:

The screenshot shows the NRGence PE6324LG web interface. The top navigation bar includes 'Energy', 'User', 'Log', 'Setup' (highlighted with a red circle), and 'PDU'. The main content area is titled 'Device Configuration | Security'. On the left, a vertical list of ports [01] through [24] is shown. The right pane displays the 'General' configuration section for the device. The 'General' section includes fields for PDU Name (PE6324LJA), MAC Address (00:10:74:A1:01:01), Firmware Version (FW Ver:1.3.121), and Rack Location name (PE6324LG). The 'Service Ports' section has radio buttons for 'Only HTTPs' (selected) and 'HTTP / HTTPs', with input fields for HTTP (80) and HTTPs (443). The 'IPv4 Configuration' section has radio buttons for 'Obtain IP address automatically [DHCP]' (selected) and 'Set IP address manually [Fixed IP]'. Below these are input fields for IP Address (10.0.52.98), Subnet Mask (255.255.254.0), and Default Gateway (10.0.52.254). There are also radio buttons for 'Obtain DNS server address automatically' (selected) and 'Set DNS server address manually', with input fields for Preferred DNS Server (10.0.1.7) and Alternate DNS Server (10.0.1.8).

3. Fill in the **IPv4 Configuration** fields according to the information provided under *IPv4 Configuration*, page 42.

Changing the Administrator Login

To change the default Administrator username and password, do the following:

1. Click the **User** tab.

The Accounts page has a detailed list of user accounts – with more information about them – in the large central panel:

The screenshot shows the 'Administrator information' section of the web interface. It includes the following fields and sections:

- Administrator:** Name: administrator, Password: [masked]
- SNMPv3 account information:** Name: administrator, Auth-password: [masked], Priv-Password: [masked]
- SNMPv1/v2c community:** Read community: administrator, Write community: administrator
- User information table:**

Management	Name	Password
Enable	1	*
Enable	2	*
Enable	3	*
Enable	4	*
Enable	5	*
Enable	6	*
Enable	7	*
Disable		

2. In the **Administrator Information** section, reset the name and password fields to something unique, then click **Save** (at the bottom of the page.)

Note: If you forget the Administrator's name or password, short the mainboard jumper to restore the default Administrator account. See see *Administrator Login Failure*, page 77 in the Appendix for full details.

Moving On

After setting up the network and changing the default Administrator username and password, you can proceed to other administration activities – including adding users. This is covered in the next chapter.

Chapter 4

Browser Operation

Logging In

The eco PDU can be accessed via a supported Internet browser from any platform.

Note: Browsers must support SSL 128 bit encryption.

To access the eco PDU do the following:

1. Open your browser and specify the IP address of the eco PDU you want to access in the browser's URL location bar.

Note: You can get the IP address from the eco PDU administrator, or see *IP Address Determination*, page 64, for information about setting it up yourself.

2. If a Security Alert dialog box appears, accept the certificate – it can be trusted. The Login page appears:

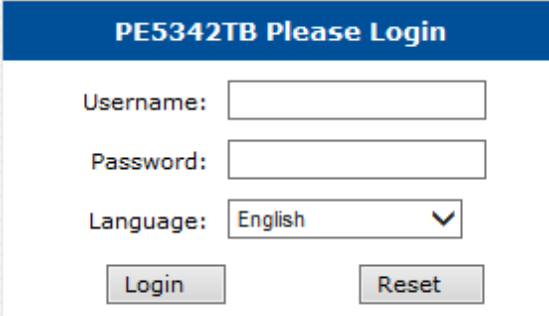

PE5342TB Please Login

Username:

Password:

Language: ▼

3. Provide a valid Username and Password (set by the eco PDU administrator), and select your language. (Options are: English [default]; Traditional Chinese; Simplified Chinese; Japanese; German; Italian; Spanish; French, Russian, Korean, Portuguese).
4. Then Click **Login** to bring up the browser Main Page.

The eco PDU Main Page

After you have successfully logged in, the eco PDU Main Page comes up with the Outlet Access *Connections* page displayed:

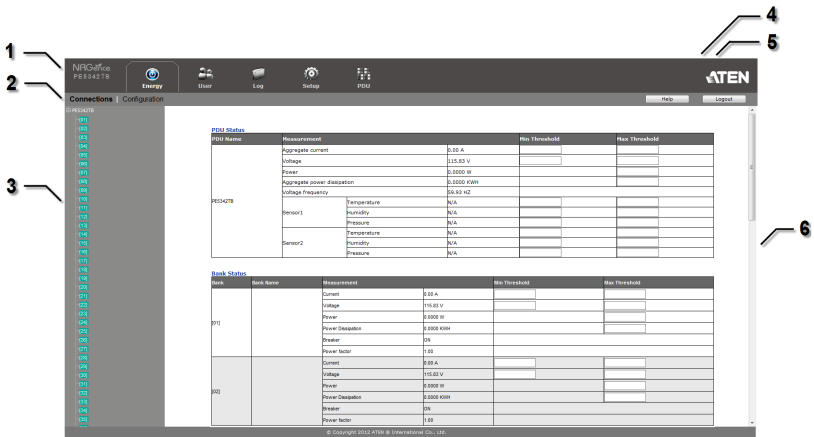

Note: The screen depicts an Administrator's page. Depending on a user's type and permissions, and your PE model, not all of these elements appear.

Page Components

The web page screen components are described in the table, below:

No.	Item	Description
1	Tab Bar	The tab bar contains the eco PDU's main operation categories. The items that appear in the tab bar are determined by the user's type, and the authorization options that were selected when the user's account was created.
2	Menu Bar	The menu bar contains operational sub-categories that pertain to the item selected in the tab bar. The items that appear in the menu bar are determined by the user's type, and the authorization options that were selected when the user's account was created.
3	Sidebar	The Sidebar provides a tree view listing of outlets that relate to the various tab bar and menu bar selections.
4	Help	Connects to on-line help at the ATEN website for the device's configuration and operation.
5	Logout	Click this button to log out of your eco PDU session.
6	Interactive Display Panel	This is your main work area. The screens that appear reflect your menu choices and Sidebar node selection.

Energy

Connections

When you login to the eco PDU, the interface opens on the Energy tab; and the *Connections* menu. The contents of the **PDU Status** and **Bank Status** sections are displayed in the main panel.

The screenshot shows the NRGeco PE5342TB PDU web interface. The top navigation bar includes 'Energy', 'User', 'Log', 'Setup', and 'PDU' tabs, along with 'Help' and 'Logout' buttons. The main content area is divided into two sections: 'PDU Status' and 'Bank Status'.

PDU Status

PDU Name	Measurement	Value	Min Threshold	Max Threshold	
PE5342TB	Aggregate current	0.00 A			
	Voltage	115.83 V			
	Power	0.0000 W			
	Aggregate power dissipation	0.0000 KWH			
	Voltage frequency	59.93 HZ			
	Sensor1	Temperature	N/A		
		Humidity	N/A		
		Pressure	N/A		
	Sensor2	Temperature	N/A		
		Humidity	N/A		
Pressure		N/A			

Bank Status

Bank	Bank Name	Measurement	Value	Min Threshold	Max Threshold
[01]		Current	0.00 A		
		Voltage	115.83 V		
		Power	0.0000 W		
		Power Dissipation	0.0000 KWH		
		Breaker	ON		
		Power factor	1.00		
[02]		Current	0.00 A		
		Voltage	115.83 V		
		Power	0.0000 W		
		Power Dissipation	0.0000 KWH		
		Breaker	ON		
		Power factor	1.00		

PDU Status

All eco PDU models support PDU device level monitoring. The **PDU Status** section allows you to set up a power management configuration for the PDU device as a whole:

PDU Status

PDU Name	Measurement		Min Threshold	Max Threshold	
PE5342TB	Aggregate current	0.00 A			
	Voltage	115.28 V			
	Power	0.0000 W			
	Aggregate power dissipation	0.0000 KWH			
	Voltage frequency	60.02 HZ			
	Sensor1	Temperature	N/A		
		Humidity	N/A		
		Pressure	N/A		
	Sensor2	Temperature	N/A		
		Humidity	N/A		
Pressure		N/A			

■ PDU Threshold Settings

These fields are used to set the maximum, minimum, and fluctuation threshold settings for Aggregate Current, Voltage, Power, and Aggregate Power Dissipation. If a range falls below the minimum setting, or exceeds the maximum setting an alarm is triggered.

- ◆ **Voltage Frequency** is displayed here in Hz.
- ◆ **Power Factor** displays a ratio between real and virtual power, providing a power performance value based on external power sources (i.e. not related to the eco PDU device).
- ◆ **Sensor 1 / Sensor 2**

If you have sensors installed in your installation, use these fields to set the maximum, minimum, and fluctuation threshold settings for Temperature, Humidity, and Pressure.

Note: Sensors are optional accessories. Check with your dealer for information about NRGence eco Sensors software.

Bank Status

The PE5324T / PE5342T PDU models support bank level and circuit breaker monitoring. The **Bank Status** section allows you to set up separate power management configurations for the banks:

Bank Status

Bank	Bank Name	Measurement	Value	Min Threshold	Max Threshold
[01]		Current	0.00 A	<input type="text"/>	<input type="text"/>
		Voltage	115.11 V	<input type="text"/>	<input type="text"/>
		Power	0.0000 W	<input type="text"/>	<input type="text"/>
		Power Dissipation	0.0000 KWH	<input type="text"/>	<input type="text"/>
		Breaker	ON		
		Power factor	1.00		
[02]		Current	0.00 A	<input type="text"/>	<input type="text"/>
		Voltage	115.11 V	<input type="text"/>	<input type="text"/>
		Power	0.0000 W	<input type="text"/>	<input type="text"/>
		Power Dissipation	0.0000 KWH	<input type="text"/>	<input type="text"/>
		Breaker	ON		
		Power factor	1.00		

■ Bank Threshold Settings

These fields are used to set the maximum and minimum threshold settings for Current, Voltage, Power, and Power Dissipation. If a range falls below the minimum setting, or exceeds the maximum setting an alarm is triggered.

- ◆ **Breaker** status (ON / OFF) displays here.

Power Factor displays a ratio between real and virtual power, providing a power performance value based on external power sources (i.e. not related to the eco PDU device).

Configuration

The *Configuration* page is used to give a distinctive name to all the banks (PE5324T / PE5342T only) and outlets:

Buzzer Setting

Enable Buzzer Alarm

Bank Configuration

Bank	Bank Name
[01]	<input type="text"/>
[02]	<input type="text"/>

Outlet Configuration

Outlet	Outlet Name
[01]	<input type="text"/>
[02]	<input type="text"/>
[03]	<input type="text"/>
[04]	<input type="text"/>
[05]	<input type="text"/>
[06]	<input type="text"/>
[07]	<input type="text"/>

- ◆ Click inside the field to input a name for a bank or outlet. The maximum number of characters is 15; input only alphanumeric characters, [Space] and [Underscore].
- ◆ Click **Save**, located at the bottom right of the page, to save the names.

User

When you select the *User* tab the screen comes up with *Administrator Information* and *User Information* displayed in the main panel. The eco PDU supports one Administrator account and up to eight User accounts.

- Note:**
1. Each account can support 2 login sessions
 2. The eco PDU supports a total of 3 concurrent login sessions.

Administrator information

Name: Password:

SNMPv3 account information

Name: Auth-password: Priv-Password:

SNMPv1/v2c community

Read community: Write community:

User information

Management	Name	Password
Enable <input type="button" value="v"/>	test01	*****
Disable <input type="button" value="v"/>		
Disable <input type="button" value="v"/>		
Disable <input type="button" value="v"/>		
Disable <input type="button" value="v"/>		
Disable <input type="button" value="v"/>		
Disable <input type="button" value="v"/>		
Disable <input type="button" value="v"/>		

Administrator Information

This section is used to set the Administrator name and password. Only Administrators can view this section. For details, see *Changing the Administrator Login*, page 28.

SNMPv3 Account Information

- ◆ Enter values for **Name**, **Auth-Password** and **Priv-Password** for SNMPv3 authentication, if required.

SNMPv1/V2c Community

- ◆ Enter values **Read community** and **Write community** for SNMPv1/V2c authentication, if required.
- ◆ Click **Save** to save the information

User Information

Use this section to add, enable, disable, or edit user accounts.

User information		Management	Name	Password
Enable ▾		test01		*****
Disable ▾				
Disable ▾				
Disable ▾				
Disable ▾				
Disable ▾				
Disable ▾				
Disable ▾				

Save

To add a user, do the following:

1. Set the Management field to *Enable*.
2. Key in a name and password in the Name and Password fields.
3. Click **Save** to save your settings.

Note: Values must be entered in both the Name and Password fields in order to enable an account.

The various options are explained in the following table:

Field	Description
Management	The Management field allows you to Enable or Disable a user's account: <ul style="list-style-type: none"> ◆ Enable – stores the user account ◆ Disable – disables the user account
Name	From 1 to 16 characters are allowed depending on the Account Policy settings. See <i>Account Policy</i> , page 49.
Password	From 1 to 16 characters are allowed depending on the Account Policy settings. See <i>Account Policy</i> , page 49.
Save	Click this button to save your operation or changes

Log

The *Log* tab keeps a record of transactions that take place on its installation, and stores up to 128 events at one time. The *System Log* page provides a powerful array of filters and functions that allow you to view and export the log file data, as well as be informed by email of specified events as they occur.

No.	Date/Time	Category	Severity	User	Description
001	2014-07-16 23:44:10	Device	Information	administrator	Bank 1 name was changed by administrator.
002	2014-07-16 23:43:52	Device	Information	administrator	Bank 1 name was changed by administrator.
003	2014-07-16 23:01:22	Device	Information		Outlet 6 was turned OFF.
004	2014-07-16 23:01:21	Device	Information	administrator	OFF command issued to Outlet 6 by administrator.
005	2014-07-16 23:01:13	Device	Information		Outlet 3 was turned OFF.
006	2014-07-16 23:01:12	Device	Information	administrator	OFF command issued to Outlet 3 by administrator.
007	2014-07-16 23:01:06	Device	Information		Outlet 1 was turned OFF.
008	2014-07-16 23:01:05	Device	Information	administrator	OFF command issued to Outlet 1 by administrator.
009	2014-07-16 21:33:21	User Management	Information	administrator	User (Username: as) access rights were modified by administrator.
010	2014-07-16 21:33:21	User Management	Information	administrator	User (Username: ds) access rights were modified by administrator.
011	2014-07-16 21:33:21	User Management	Information	administrator	User (Username: ft) access rights were modified by administrator.
012	2014-07-16 21:32:41	User Management	Information	administrator	User (Username: as) access rights were modified by administrator.
013	2014-07-16 21:31:29	Authentication	Information	administrator	administrator 10.3.41.62 logged in.
014	2014-07-16 20:39:33	Authentication	Information	administrator	administrator 10.3.52.74 logged out.
015	2014-07-16 14:40:19	Device	Information	administrator	Outlet 24 name was changed by administrator.
016	2014-07-16 14:40:19	Device	Information	administrator	Outlet 23 name was changed by administrator.
017	2014-07-16 14:40:18	Device	Information	administrator	Outlet 22 name was changed by administrator.

Buttons: Clear, First Page, Previous Page, Next Page, Last Page, Save

The System Log Event List

- ◆ Clicking on a device in the Sidebar displays its log events in the main panel's log event list.
- ◆ Clicking the **Refresh** button brings the log list up to date with the latest events.
- ◆ The entry box to the right of the Refresh button lets you set the number of events to display per page. Simply key in the number of your choice.
- ◆ The top right of the main panel shows the total number of pages in the log file, and what page you are currently viewing.
- ◆ The buttons on the bottom row function as follows:
 - ◆ **Clear** – click to erase the contents of the log event list
 - ◆ **First Page** – click to go to the first page of the log event list
 - ◆ **Previous Page** – click to move to the previous page of the log event list
 - ◆ **Next Page** – click to move to the next page of the log event list
 - ◆ **Last Page** – click to move to the last page of the log event list
 - ◆ **Save** – click to save the contents of the log event list to file.

Notification Settings

The *Notification Settings* page is used to specify which of the eco PDU's components will receive notification of a log event. When you click the Notification Settings menu item, a page similar to the one below appears:

Event Log Settings			
Event List			
Event	Syslog	E-mail	SNMP
▼ Enable all system events	<input type="checkbox"/>	<input type="checkbox"/>	<input type="checkbox"/>
Log export succeeded	<input checked="" type="checkbox"/>	<input checked="" type="checkbox"/>	<input checked="" type="checkbox"/>
System event log (SEL) cleaned	<input checked="" type="checkbox"/>	<input checked="" type="checkbox"/>	<input checked="" type="checkbox"/>
FW upgrade succeeded	<input checked="" type="checkbox"/>	<input checked="" type="checkbox"/>	<input checked="" type="checkbox"/>
FW upgrade failed	<input checked="" type="checkbox"/>	<input checked="" type="checkbox"/>	<input checked="" type="checkbox"/>
Device configuration restore succeeded	<input checked="" type="checkbox"/>	<input checked="" type="checkbox"/>	<input checked="" type="checkbox"/>
Device configuration restore failed	<input checked="" type="checkbox"/>	<input checked="" type="checkbox"/>	<input checked="" type="checkbox"/>
Device configuration backup succeeded	<input checked="" type="checkbox"/>	<input checked="" type="checkbox"/>	<input checked="" type="checkbox"/>
Device configuration settings modified	<input checked="" type="checkbox"/>	<input checked="" type="checkbox"/>	<input checked="" type="checkbox"/>
Security settings modified	<input checked="" type="checkbox"/>	<input checked="" type="checkbox"/>	<input checked="" type="checkbox"/>
FW upgrade started	<input checked="" type="checkbox"/>	<input checked="" type="checkbox"/>	<input checked="" type="checkbox"/>
Device rebooted	<input checked="" type="checkbox"/>	<input checked="" type="checkbox"/>	<input checked="" type="checkbox"/>
PDU get new IP address	<input checked="" type="checkbox"/>	<input checked="" type="checkbox"/>	<input checked="" type="checkbox"/>
▶ Enable all Authentication events	<input type="checkbox"/>	<input type="checkbox"/>	<input type="checkbox"/>
▶ Enable all User Management events	<input type="checkbox"/>	<input type="checkbox"/>	<input type="checkbox"/>
▶ Enable all Device Management events	<input type="checkbox"/>	<input type="checkbox"/>	<input type="checkbox"/>

- ◆ The event categories are listed in the left column.
 - ◆ When you first open the page, only the main category items appear. (Main category item rows have a gray background.)
 - ◆ Sub-category items are nested under the main category headings. Click the arrow in front of the main category headings to display the subcategory items. (Sub-category item rows have a white background.)
- ◆ Click the checkboxes under the column headings to select which component(s) will receive notification of the log events.
 - ◆ Clicking on a main category heading's row automatically selects all the sub-category items nested below it.
 - ◆ If you only want to set notification for some of the sub-category events, don't put a check in the main category row. Instead, drop down the sub-category list, and only check the sub-category events you want.
- ◆ When you have finished making your setting choices, click Save. When a specified log event occurs, notification of that event will be sent to the selected component.
- ◆ Reset Digital Output: If an event has been triggered that changes the digital output sensor from Low to High, click this button to return the sensor to the Low state.

Setup

The *Device Management* page allows administrators and users with device management permission to configure and control overall eco PDU operations.

Device Configuration

This page presents information about the selected device, as described in the following sections:

General

General

PDU Name:

MAC Address: 00:10:74:A1:A1:A1

Firmware Version: F/W Ver:1.0.068

Rack Location name:

Item	Meaning
PDU Name	This field lets you give the device a unique name. Simply delete whatever is in the text box and key in the name of your choice. Click Save (located at the bottom of the page) to save the new name.
MAC Address	This item displays the eco PDU's MAC address.
Firmware Version	This item displays the current firmware version number. You can reference it to see if there are newer versions available on the ATEN website.
Rack Location Name	This field lets you give the rack location a unique name for easy reference.

Service Ports

As a security measure, if a firewall is being used, the Administrator can specify the port numbers that the firewall will allow. If a port other than the default is used, users must specify the port number as part of the IP address when they log in. If an invalid port number (or no port number) is specified, the eco PDU will not be found.

Select whether to allow only secure browser logins, as show below:

Service Ports

Only HTTPs HTTP / HTTPs

HTTP:

HTTPs:

An explanation of the fields is given in the table below:

Field	Explanation
HTTP	The port number for a browser login. The default is 80.
HTTPS	The port number for a secure browser login. The default is 443.

- Note:**
1. Valid entries for all of the Service Ports are from 1–65535.
 2. The service ports cannot have the same value. You must set a different value for each one.
 3. If there is no firewall (on an Intranet, for example), it doesn't matter what these numbers are set to, since they have no effect.

IPv4 Configuration

The PDU's IPv4 IP and DNS addresses (the traditional method of specifying IP addresses) can either be assigned dynamically (DHCP), or a fixed IP address can be specified.

IPv4 Configuration

Obtain IP address automatically [DHCP]

Set IP address manually [Fixed IP]

IP Address:

Subnet Mask:

Default Gateway:

Obtain DNS server address automatically

Set DNS server address manually

Preferred DNS Server:

Alternate DNS Server:

- ◆ For dynamic IP address assignment, select the *Obtain IP address automatically* radio button. (This is the default setting.)
- ◆ To specify a fixed IP address, select the *Set IP address manually* radio button and fill in the IP address with values appropriate for your network.
- ◆ For automatic DNS Server address assignment, select the *Obtain DNS Server address automatically* radio button.
- ◆ To specify the DNS Server address manually, select the *Set DNS server address manually* radio button, and fill in the addresses for the Preferred and Alternate DNS servers with values appropriate for your network.

-
- Note:** 1. If you choose *Obtain IP address automatically*, when the device starts up it waits to get its IP address from the DHCP server. If it hasn't obtained the address after one minute, it automatically reverts to its factory default IP address (192.168.0.60.)
2. If the device is on a network that uses DHCP to assign network addresses, and you need to ascertain its IP address, see *IP Address Determination*, page 64, for information.
3. Specifying the Alternate DNS Server address is optional.
-

Event Notification

The Event Notification section is divided into three sections: SMTP Settings; SNMP Trap Receivers; and Syslog Server. Each section is described below.

◆ SMTP Settings

Event Notification

SMTP Server

Enable report from the following SMTP Server

SMTP Server:

My server requires authentication

Account Name:

Password:

From:

To:

To have the eco PDU device email reports from the SMTP server to you, do the following:

1. Enable the *Enable report from the following SMTP server*, and key in the IP address of your SMTP server.
2. If your server requires authentication, put a check in the *My server requires authentication* checkbox.
3. Key in the appropriate account information in the *Account Name*, *Password*, and *From* fields.

Note: Only one email address is allowed in the *From* fields, and it cannot exceed 64 characters.)

4. Key in the email address (addresses) of where you want the event reports sent to in the *To* field.

Note: If you are sending the report to more than one email address, separate the addresses with a semicolon. The total cannot exceed 256 characters.

◆ SNMP Trap Receivers

SNMP Trap Receiver

<input type="checkbox"/> Enable SNMP Trap	<input checked="" type="radio"/> SNMPv3	<input type="radio"/> SNMPv2c	<input type="radio"/> SNMPv1
Receiver IP 1:	<input type="text" value="0.0.0.0"/>		
Service Port 1:	<input type="text" value="162"/>		
Community 1:	<input type="text"/>		
User name 1:	<input type="text"/>		
Auth-password 1:	<input type="text"/>		
Priv-Password 1:	<input type="text"/>		
Receiver IP 2:	<input type="text" value="0.0.0.0"/>		
Service Port 2:	<input type="text" value="162"/>		
Community 2:	<input type="text"/>		
User name 2:	<input type="text"/>		
Auth-password 2:	<input type="text"/>		
Priv-Password 2:	<input type="text"/>		

Up to four SNMP management stations can be specified. If you want to use SNMP trap notifications, do the following:

1. Check *Enable SNMP Trap*.
2. Select which version of SNMP you want to use.
3. Key in the IP address(es) and the service port number(s) of the computer(s) to be notified of SNMP trap events. The valid port range is 1–65535. The default port number is 162.

Note: Make sure that the port number you specify here matches the port number used by the SNMP receiver computer.

4. Key in the community value(s) if required for the SNMP version.
5. Key in the auth/privacy password(s) that correspond to each of the stations.

Syslog Server

Syslog Server

Enable Syslog Server

Server IP:

Service Port:

To record all the events that take place on eco PDU devices and write them to the eco PDU Syslog server, do the following:

1. Check **Enable Syslog Server**.
2. Key in the IP address and the port number of the Syslog server. The valid port range is 1-65535. The default port number is 514.

Date/Time

The Date/Time dialog page sets the eco PDU time parameters:

Date Time

Time Zone

(GMT-12:00) Eniwetok Kwajalein ▾

Daylight Savings Time

Manual Input

Date: 
(YYYY-MM-DD)

Time: (HH:MM:SS)

Sync with PC

Network Time

Enable auto adjustment

AU | ntp1.cs.mu.OZ.AU ▾

Preferred custom server IP:

Alternate time server:

AU | ntp1.cs.mu.OZ.AU ▾

Alternate custom server IP:

Adjust time everyday

Adjust Time Now

Time Zone

- ◆ To establish the time zone that the eco PDU is located in, drop down the *Time Zone* list and choose the city that most closely corresponds to where it is at.
- ◆ If your country or region employs Daylight Saving Time (Summer Time), check the corresponding checkbox.

Manual Input

Use this section to specify the eco PDU's date and time manually.

- ◆ Click the calendar icon and click the calendar entry for the date.
- ◆ Key the time into the Time field, using the HH:MM:SS (hours, minutes, seconds) format.

Note: This section is only enabled when *auto adjustment* (in the *Network Time* section) is disabled (the checkbox is unchecked).

As an alternative to specifying the date and time by entering them into the date and time fields, you can click to put a check in the *Sync with PC* checkbox, in which case the eco PDU will take its date and time settings from the locally connected PC.

Network Time

To have the time automatically synchronized to a network time server, do the following:

1. Check the *Enable auto adjustment* checkbox.
2. Drop down the time server list to select your preferred time server
– or –

Check the *Preferred custom server IP* checkbox, and key in the IP address of the time server of your choice.

3. If you want to configure an alternate time server, check the *Alternate time server* checkbox, and repeat step 2 for the alternate time server entries.
4. Key in your choice for the number of days between synchronization procedures.

Finishing Up

When you have finished making your settings on this page, click **Save**.

After you have saved your changes, if you want to synchronize immediately, click **Adjust Time Now**.

Security

The *Security* page controls access to the eco PDU device.

Security

Login Failures

Allowed:

Timeout: min

Working Mode

Enable ICMP

Session Timeout

Enable Web Session Timeout in Minute(s)

Login Failures

- ◆ **Allowed** sets the number of consecutive failed login attempts that are permitted from a remote user.
- ◆ **Timeout** sets the amount of time a remote user must wait before attempting to login again after exceeding the number of allowed failures.

Working Mode

- ◆ If *ICMP* is **enabled**, the eco PDU device can be pinged. If it is not enabled, the device cannot be pinged. The default is Enabled.

Session Timeout

- ◆ If *Web Session Timeout* is **enabled**, you can enter the number of minutes that can pass before the system forces a user to logout of the session.
- ◆ When you have finished making your settings on this page, click **Save**.

Account Policy

The Account Policy section governs policies in regard to usernames and passwords.

Account Policy

Minimum Username Length:

Minimum Password Length:

Password Must Contain At Least:

- One Upper Case
- One Lower Case
- One Number

Disable Duplicate Login

Check a policy and enter the required information in the appropriate fields.

Item	Description
Minimum Username Length	Sets the minimum number of characters required for a username. Acceptable values are from 1–16.
Minimum Password Length	Sets the minimum number of characters required for a password. Acceptable values are from 1–16.
Password Must Contain At Least	Checking any of these items requires users to include at least one of the specified items in their password. Note: This policy does not affect existing user accounts. Only new user accounts created after this policy has been enabled, and users required to change their passwords are affected.
Disable Duplicate Login	Check this to prevent users from logging in with the same account at the same time.

Login String / IP Filter / Mac Filter

Login String/IP Filter/MAC Filter

Login String:

IP Filter Enable Include Exclude

MAC Filter Enable Include Exclude

■ Login String

The *Login String* entry field is used to specify a login string (in addition to the IP address) that users must include when accessing the eco PDU device with a browser. For example:

192.168.0.126/abcdefg

- ◆ The following characters are allowed:

0–9 a–z A–Z ~ ! @ \$ * () _ ' ,

- ◆ The following characters are not allowed:

& ^ { } ' ' < > | " % ” : / ? # \ [Space] + - = [] ;

Compound characters (É Ç ñ ... etc.)

Note: 1. There must be a forward slash between the IP address and the string.

2. If no login string is specified here, anyone will be able to access the eco PDU device login page using the IP address alone. This makes your installation less secure.
-

For security purposes, we recommend that you change this string occasionally.

■ IP Filter / MAC Filter

If any filters have been configured, they appear in the IP Filter and/or MAC Filter list boxes.

IP and MAC Filters control access to the eco PDU based on the IP and/or MAC addresses of the client computers attempting to connect. A maximum of 5 IP filters and 5 MAC filters are allowed.

To enable IP and/or MAC filtering, click to put a check mark in the *IP Filter Enable* and/or *MAC Filter Enable* checkbox.

- ◆ If the include button is checked, all the addresses within the filter range are allowed access; all other addresses are denied access.
- ◆ If the exclude button is checked, all the addresses within the filter range are denied access; all other addresses are allowed access.

Adding Filters

To add an IP filter, do the following:

1. Click **Add**. A dialog box similar to the one below appears:

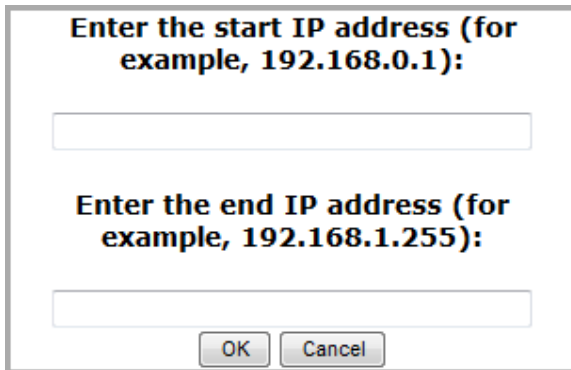

Enter the start IP address (for example, 192.168.0.1):

Enter the end IP address (for example, 192.168.1.255):

OK Cancel

2. Specify the start filter address in the dialog box (for example, 192.168.0.200), then click **OK**.
3. To filter a single IP address, key in the same address as the start IP. To filter a continuous range of addresses, key in the end number of the range (for example, 192.168.0.225).
4. After filling in the address, click **OK**.

Repeat these steps for any additional IP addresses you want to filter.

To add a MAC filter, do the following:

1. Click **Add**. A dialog box similar to the one below appears:

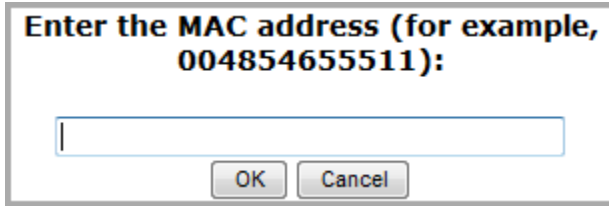

2. Specify the MAC address in the dialog box (for example, 001074670000), then click **OK**.

Repeat these steps for any additional MAC addresses you want to filter.

IP Filter / MAC Filter Conflict

If there is a conflict between an IP filter and a MAC filter – for example, where a computer’s IP address is allowed by the IP filter but its MAC address is excluded by the MAC filter – then that computer’s access is blocked.

In other words, if either filter blocks a computer, then the computer is blocked, no matter what the other filter is set to.

Modifying Filters

To modify a filter, select it in the IP Filter or MAC Filter list box and click **Modify**. The Modify dialog box is similar to the Add dialog box. When it comes up, simply delete the old address(es) and replace it with the new one(s).

Deleting Filters

To delete a filter, select it in the IP Filter or MAC Filter list box and click **Delete**.

Authentication & Authorization

The Authentication & Authorization page is used to set up login authentication and authorization management from external sources.

Authentication & Authorization

RADIUS Settings

Enable RADIUS

Preferred RADIUS Server IP:

Preferred RADIUS Service Port:

Alternate RADIUS Server IP:

Alternate RADIUS Server Port:

Timeout: sec

Retries:

Shared Secret (at least 6 characters):

RADIUS Settings

To allow authentication and authorization for the eco PDU device through a RADIUS server, do the following:

1. Check **Enable**.
2. Fill in the IP addresses and service port numbers for the Preferred and Alternate RADIUS servers. The default port number for the Preferred server is 1812; the default port number for the Alternate server is 1645.

Note: Make sure that the port numbers you specify here match the port numbers used by the RADIUS servers.

3. In the *Timeout* field, set the time in seconds that the eco PDU device waits for a RADIUS server reply before it times out.
4. In the *Retries* field, set the number of allowed retries for attempting to connect to the RADIUS server.
5. In the *Shared Secret* field, key in the character string that you want to use for authentication between the eco PDU device and the RADIUS Server.

6. On the RADIUS server, set the entry for each user as follows:

```
su/administrator or su/user
```

Where *xxxx* represents the Username given to the user when the account was created on the eco PDU device. The user's access rights are the ones assigned for the eco PDU device, as well. (See *User Information*, page 37.)

Note: su/user supports view ports only; su/administrator supports all eco PDU functions.

Private Certificate

When logging in over a secure (SSL) connection, a signed certificate is used to verify that the user is logging in to the intended site. For enhanced security, the *Private Certificate* section allows you to use your own private encryption key and signed certificate, rather than the default ATEN certificate.

Private Certificate

Private Key:	<input type="text"/>	<input type="button" value="Browse..."/>	
Certificate:	<input type="text"/>	<input type="button" value="Browse..."/>	
		<input type="button" value="Upload"/>	<input type="button" value="Restore default"/>

There are two methods for establishing your private certificate: generating a self-signed certificate; and importing a third-party certificate authority (CA) signed certificate.

Generating a Self-Signed Certificate

If you wish to create your own self-signed certificate, a free utility – openssl.exe – is available for download over the web.

Obtaining a CA Signed SSL Server Certificate

For the greatest security, we recommend using a third party certificate authority (CA) signed certificate. To obtain a third party signed certificate, go to a CA (Certificate Authority) website to apply for an SSL certificate. After the CA sends you the certificate and private encryption key, save them to a convenient location on your computer.

(Continues on next page.)

Importing the Private Certificate

To import the private certificate, do the following:

1. Click **Browse** to the right of *Private Key*; browse to where your private encryption key file is located; and select it.
2. Click **Browse** to the right of *Certificate*; browse to where your certificate file is located; and select it.
3. Click **Upload** to complete the procedure.

Note: 1. Clicking **Restore Default** returns the device to using the default ATEN certificate.

2. Both the private encryption key and the signed certificate must be imported at the same time.
-

When you have finished making your settings on this page, click **Save**.

PDU

The *PDU* tab is used to upgrade the eco PDU's firmware, and to backup and restore the device's configuration settings.

Firmware File

When you click the **Maintenance** tab, the display opens with the *Firmware Upgrade* menu page, which looks similar to the one below:

Firmware File

Check Main Firmware Version

Energy Box Name	F/W Version
[PE6324LJA]	F/W Ver:1.3.121

Filename:

Backup

Password:

Restore

Filename:

Password:

A description of the items shown in this panel are given in the table, below:

Item	Description
Check Main Firmware Version	If you enable <i>Check Main Firmware Version</i> , the eco PDU's current firmware level is compared with that of the upgrade file. If the current version is equal to or higher than the upgrade version, a popup message appears, to inform you of the situation and stops the upgrade procedure.
Name	Lists all of the eco PDU devices. Click to put a check in the checkbox of the device's whose firmware you want to upgrade.
F/W Version	Displays the eco PDU's current firmware version.
Filename	As new versions of the firmware become available, they are posted on our website and can be downloaded to a convenient location on your computer. Click the <i>Browse</i> button to select the downloaded upgrade file.
Upgrade	Click this button to upgrade the firmware of the selected devices.

■ Upgrading the Firmware

To upgrade the firmware refer to the screenshot on the preceding page, and do the following:

1. Go to our website and download the new firmware file to a convenient location on your computer.
2. Click the *Browse* button; navigate to where the firmware file is located and select it.
3. Click **Upgrade** to start the upgrade procedure.
 - ◆ If you enabled *Check Main Firmware Version* the current firmware level is compared with that of the upgrade file. If the current version is equal to or higher than the upgrade version, a popup message appears, to inform you of the situation and stops the upgrade procedure.
 - ◆ If you didn't enable *Check Main Firmware Version*, the upgrade file is installed without checking what its level is.
 - ◆ Once the upgrade completes successfully, the switch resets itself.
4. Log in again, and check the firmware version to be sure it is the new one.

■ Firmware Upgrade Recovery

Should the eco PDU's firmware upgrade procedure fail, and the device becomes unusable, the following firmware upgrade recovery procedure will resolve the problem:

1. Power off the device.
2. Press and hold the Reset Switch in (see page 18).
3. While holding the Reset Switch in, power the switch back on.

This causes the switch to use the original factory installed main firmware version. Once the switch is operational, you can try upgrading the main firmware again.

Backup/Restore

Selecting *Backup/Restore* on the menu bar gives you the ability to back up the switch's configuration and user profile information:

Backup

To backup the device's settings do the following:

1. In the *Password* field, key in a password for the file.

Note: Entering a password is optional. If you do enter a password, make a note of it, since you will need it to be able to restore the file.

2. Click **Save**.
3. When the browser asks what you want to do with the file, select *Save to disk*; then save it in a convenient location.

Restore

To restore a previous backup, do the following:

1. Click **Browse**; navigate to the file and select it.

Note: If you renamed the file, you can leave the new name. There is no need to return it to its original name.

2. In the *Password* field, key in the same password that you used to save the file.

Note: If you did not set a password when you created the backup file, you can omit this step.

3. Select as many of the options that are presented as you wish to restore.
4. Click **Restore**.

After the file is restored, a message appears to inform you that the procedure succeeded.

Safety Instructions

General

- ◆ This product is for indoor use only.
- ◆ Read all of these instructions. Save them for future reference.
- ◆ Follow all warnings and instructions marked on the device.
- ◆ Do not place the device on any unstable surface (cart, stand, table, etc.). If the device falls, serious damage will result.
- ◆ Do not use the device near water.
- ◆ Do not place the device near, or over, radiators or heat registers.
- ◆ The device cabinet is provided with slots and openings to allow for adequate ventilation. To ensure reliable operation, and to protect against overheating, these openings must never be blocked or covered.
- ◆ The device should never be placed on a soft surface (bed, sofa, rug, etc.) as this will block its ventilation openings. Likewise, the device should not be placed in a built in enclosure unless adequate ventilation has been provided.
- ◆ Never spill liquid of any kind on the device.
- ◆ Unplug the device from the wall outlet before cleaning. Do not use liquid or aerosol cleaners. Use a damp cloth for cleaning.
- ◆ The device should be operated from the type of power source indicated on the marking label. If you are not sure of the type of power available, consult your dealer or local power company.
- ◆ To prevent damage to your installation it is important that all devices are properly grounded.
- ◆ The device is designed for IT power distribution systems with 100V to 230V phase-to-phase voltage.
- ◆ The device is equipped with a 3-wire grounding type plug. This is a safety feature. If you are unable to insert the plug into the outlet, contact your electrician to replace your obsolete outlet. Do not attempt to defeat the purpose of the grounding-type plug. Always follow your local/national wiring codes.

- ◆ If an extension cord is used with this device make sure that the total of the ampere ratings of all products used on this cord does not exceed the extension cord ampere rating. Make sure that the total of all products plugged into the wall outlet does not exceed 15 amperes.
- ◆ The equipment should be installed near the wall socket outlet and the disconnect device (appliance coupler) should be readily accessible.
- ◆ Do not allow anything to rest on the power cord or cables. Route the power cord and cables so that they cannot be stepped on or tripped over.
- ◆ To help protect your system from sudden, transient increases and decreases in electrical power, use a surge suppressor, line conditioner, or uninterruptible power supply (UPS).
- ◆ Position system cables and power cables carefully; Be sure that nothing rests on any cables.
- ◆ When connecting or disconnecting power to hot pluggable power supplies, observe the following guidelines:
 - ◆ Install the power supply before connecting the power cable to the power supply.
 - ◆ Unplug the power cable before removing the power supply.
 - ◆ If the system has multiple sources of power, disconnect power from the system by unplugging all power cables from the power supplies.
- ◆ Never push objects of any kind into or through cabinet slots. They may touch dangerous voltage points or short out parts resulting in a risk of fire or electrical shock.
- ◆ Do not attempt to service the device yourself. Refer all servicing to qualified service personnel.
- ◆ If the following conditions occur, unplug the device from the wall outlet and bring it to qualified service personnel for repair.
 - ◆ The power cord or plug has become damaged or frayed.
 - ◆ Liquid has been spilled into the device.
 - ◆ The device has been exposed to rain or water.
 - ◆ The device has been dropped, or the cabinet has been damaged.
 - ◆ The device exhibits a distinct change in performance, indicating a need for service.
 - ◆ The device does not operate normally when the operating instructions are followed.

- ◆ Only adjust those controls that are covered in the operating instructions. Improper adjustment of other controls may result in damage that will require extensive work by a qualified technician to repair.
- ◆ Do not connect the RJ-11 connector marked “Sensor” to a public telecommunication network.

Rack Mounting

- ◆ Before working on the rack, make sure that the stabilizers are secured to the rack, extended to the floor, and that the full weight of the rack rests on the floor. Install front and side stabilizers on a single rack or front stabilizers for joined multiple racks before working on the rack.
- ◆ Always load the rack from the bottom up, and load the heaviest item in the rack first.
- ◆ Make sure that the rack is level and stable before extending a device from the rack.
- ◆ Use caution when pressing the device rail release latches and sliding a device into or out of a rack; the slide rails can pinch your fingers.
- ◆ After a device is inserted into the rack, carefully extend the rail into a locking position, and then slide the device into the rack.
- ◆ Do not overload the AC supply branch circuit that provides power to the rack. The total rack load should not exceed 80 percent of the branch circuit rating.
- ◆ Make sure that all equipment used on the rack – including power strips and other electrical connectors – is properly grounded.
- ◆ Ensure that proper airflow is provided to devices in the rack.
- ◆ Ensure that the operating ambient temperature of the rack environment does not exceed the maximum ambient temperature specified for the equipment by the manufacturer
- ◆ Do not step on or stand on any device when servicing other devices in a rack.

The eco PDU's Main Power Cord

Use the power cord supplied with this package. If it becomes necessary to replace the cord supplied with this package, be sure to use a cord of at least the same standard as the one provided.



Securing the Power Cables

To secure the cables in the eco PDU's power outlets, use only the ATEN Lok-U-Plug cable holders that have been specifically designed to work with the eco PDU. Using any other kind of cable securing device could be highly dangerous. Please contact your ATEN dealer for information about ATEN Lok-U-Plug.

Technical Support

International

- ◆ For online technical support – including troubleshooting, documentation, and software updates: <http://eservice.aten.com>
- ◆ For telephone support, see *Telephone Support*, page vi

North America

Email Support		support@aten-usa.com
Online Technical Support	Troubleshooting Documentation Software Updates	http://www.aten-usa.com/support
Telephone Support		1-888-999-ATEN ext 4988

When you contact us, please have the following information ready beforehand:

- ◆ Product model number, serial number, and date of purchase.
- ◆ Your computer configuration, including operating system, revision level, expansion cards, and software.
- ◆ Any error messages displayed at the time the error occurred.
- ◆ The sequence of operations that led up to the error.
- ◆ Any other information you feel may be of help.

IP Address Determination

If you are an administrator logging in for the first time, you need to access the eco PDU in order to give it an IP address that users can connect to. There are two methods to choose from. In each case, your client computer must be on the same network segment as the eco PDU. After you have connected and logged in you can give the device its fixed network address. (See *Setup*, page 40.)

Method 1:

For computers running Windows, an IP address can be determined and/or assigned with the IP Installer utility. The utility can be obtained from the *Download* area of our web site or from the software CD. Look under *Driver/SW*, and the model of your device. After downloading the utility to your computer, do the following:

1. Unzip the contents of *IPInstaller.zip* to a directory on your hard drive.
2. Go to the directory that you unzipped the IPInstaller program to and run *IPInstaller.exe*. A dialog box similar to the one below appears:

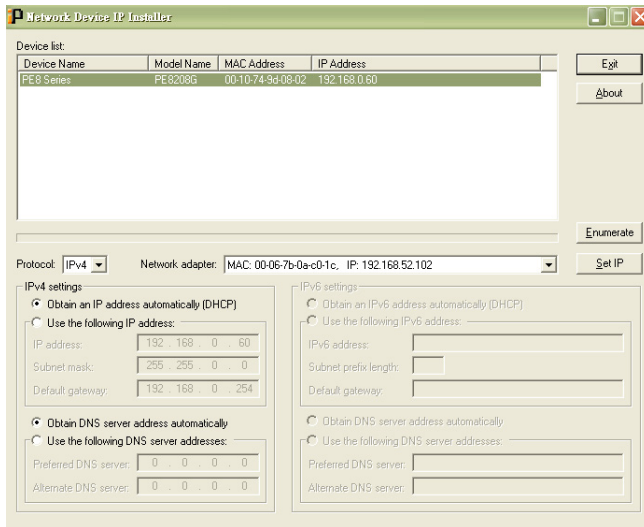

(Continues on next page.)

(Continued from previous page.)

3. Select the device in the *Device List*.

Note: 1. If the list is empty, or your device doesn't appear, click **Enumerate** to refresh the Device List.

2. If there is more than one device in the list, use the MAC address to pick the one you want. The eco PDU's MAC address is located on its bottom panel.

-
4. Select either *Obtain an IP address automatically (DHCP)*, or *Specify an IP address*. If you chose the latter, fill the IP Address, Subnet Mask, and Gateway fields with the information appropriate to your network.
 5. Click **Set IP**.
 6. After the IP address shows up in the Device List, click **Exit** to end the program.

Method 2:

1. Set your computer's IP address to 192.168.0.XXX
Where XXX represents any number or numbers except 60. (192.168.0.60) is the default address of the eco PDU.)
2. Specify the device's default IP address (192.168.0.60) in your browser, and you will be able to connect.
3. Assign a fixed IP address for the device (see *IPv4 Configuration*, page 42), that is suitable for the network segment that it resides on.
4. After you log out, reset your computer's IP address to its original value.
5. Once you have logged in, go to Network Settings to set up the permanent IP environment (see *IPv4 Configuration*, page 42).

Method 3:

ALTUSEN eco Sensors allows you to determine/assign an IP address in order to configure a PDU device and monitor power status of the equipment connected to it. ALTUSEN eco Sensors can be obtained from the Download area of the ATEN web site.

Specifications

PE5221T(B)

Function		PE5221T(B)	
Power Outlets	Direct	21	
Connectors	Power Inlet	1 x NEMA 6-20P	
	Power Outlets	Total: 18 x IEC320 C13 + 3 x IEC320 C19	
	Sensor	2 x RJ-11	
	LAN	1 x RJ-45 Female (Silver) + LEDs (Orange/Green)	
LEDs	PDU/Phase / Bank	1 digit 7-segment (Orange)	
	PDU/Phase / Bank / IP	3 (Green)	
	Current / IP Address	3-digit 7-segment (Orange)	
	Output Power Indicator	1 (Red)	
	Power	1 (Blue)	
	LAN	10/100M	1 (Orange / Green)
		Link	1 (Green)
Sensor		2 (Green)	
Switches	Reset	1 x Semi-recessed Pushbutton	
Button		1 x Pushbutton	
I/P Rating		100–240V~; 50-60 Hz; 16A (Max)	
Power Capacity		3680 VA (Max)	
O/P Rating	Per Port	C13	15A (Max); 12A (UL De-rated)
		C19	20A (Max); 16A (UL De-rated)
	Total		20A (Max); 16A (UL De-rated)
Environment	Operating Temperature	0–50°C	
	Storage Temperature	-20–60°C	
	Humidity	0–80% RH Non-condensing	
Physical Properties	Housing	Metal	
	Weight	2.34 kg	
	Dimensions (L x W x H)	90.2 x 5.6 x 4.8 cm	

PE5221T(G)

Function		PE5221T(G)	
Power Outlets	Direct	21	
Connectors	Power Inlet	1 x IEC 620320 C20	
	Power Outlets	Total: 18 x IEC320 C13 + 3 x IEC320 C19	
	Sensor	2 x RJ-11	
	LAN	1 x RJ-45 Female (Silver) + LEDs (Orange/Green)	
LEDs	PDU/Phase / Bank	1 digit 7-segment (Orange)	
	PDU/Phase / Bank / IP	3 (Green)	
	Current / IP Address	3-digit 7-segment (Orange)	
	Output Power Indicator	1 (Red)	
	Power	1 (Blue)	
	LAN	10/100M	1 (Orange / Green)
		Link	1 (Green)
Sensor		2 (Green)	
Switches	Reset	1 x Semi-recessed Pushbutton	
Button		1 x Pushbutton	
I/P Rating		100–240V~; 50-60 Hz; 16A (Max)	
Power Capacity		3680 VA (Max)	
O/P Rating	Per Port	C13	10A (Max)
		C19	16A (Max)
	Total		16A (Max)
Environment	Operating Temperature	0–40°C	
	Storage Temperature	-20–60°C	
	Humidity	0–80% RH Non-condensing	
Physical Properties	Housing	Metal	
	Weight	2.34 kg	
	Dimensions (L x W x H)	90.2 x 5.6 x 4.8 cm	

PE5221T(J)

Function		PE5221T(J)	
Power Outlets	Direct	21	
Connectors	Power Inlet	1 x NEMA 6-20p	
	Power Outlets	Total: 18 x IEC320 C13 + 3 x IEC320 C19	
	Sensor	2 x RJ-11	
	LAN	1 x RJ-45 Female (Silver) + LEDs (Orange/Green)	
LEDs	PDU/Phase / Bank	1 digit 7-segment (Orange)	
	PDU/Phase / Bank / IP	3 (Green)	
	Current / IP Address	3-digit 7-segment (Orange)	
	Output Power Indicator	1 (Red)	
	Power	1 (Blue)	
	LAN	10/100M	1 (Orange / Green)
		Link	1 (Green)
Sensor		2 (Green)	
Switches	Reset	1 x Semi-recessed Pushbutton	
Button		1 x Pushbutton	
I/P Rating		100–240V~; 50–60 Hz; 16A (Max)	
Power Capacity		3680 VA (Max)	
O/P Rating	Per Port	C13	15A (Max); 12A (UL De-rated)
		C19	20A (Max); 16A (UL De-rated)
	Total		20A (Max); 16A (UL De-rated)
Environment	Operating Temperature	0–50°C	
	Storage Temperature	-20–60°C	
	Humidity	0–80% RH Non-condensing	
Physical Properties	Housing	Metal	
	Weight	2.34 kg	
	Dimensions (L x W x H)	90.2 x 5.6 x 4.8 cm	

PE5221T - Japan

Function	PE5221T	
電源仕様	入力定格電力	100 - 240 VAC
	最大入力電流	16A (最大)
	入力周波数	50-60 Hz
	電源入力プラグ	型番 B / J のプラグの場合 : NEMA 6-20P 型番 G のプラグの場合 : IEC 60320 C20
	最大入力電力	3680 VA (最大)
	アウトレット形状	合計 : IEC320 C13 x 18 + IEC320 C19 x 3
	出力定格電力	100 - 240 VAC
	最大出力電流 (アウトレット)	型番 B / J のプラグの場合 : C13: 12A C19: 16A 型番 G のプラグの場合 : C13: 10A C19: 16A
	最大出力電流 (バンク)	16A (最大)
	最大出力電流 (合計)	16A (最大)
	計測項目	バンクレベルでの電流、電圧、VA、PF および kWh 計測
	電源切替操作	非対応
	環境センサー用ポート数	2
	計測精度	電圧 : 100VAC ~ 250VAC +/-1%
		電力 : 100W ~ Maximum Capacity +/- 2%
電流 : 0.1A~1A +/- 0.1A, 1A~20A +/-1%		
物理仕様	サイズ (L x W x H)	90.2 x 5.6 x 4.8 cm
	重量	2.34 kg
	電源ケーブル長	3 m
動作環境	温度 (操作 / 保管)	型番 B / J のプラグの場合 : 0-50° C / -20-60° C 型番 G のプラグの場合 : 0-40° C / -20-60° C
	湿度 (操作および保管)	0-80% RH、結露無きこと

PE5224TA

Function		PE5224TA	
Power Outlets	Direct	24	
Connectors	Power Inlet	1 x NEMA 5-20P	
	Power Outlets	Total: 24 x NEMA 5-20R	
	Sensor	2 x RJ-11	
	LAN	1 x RJ-45 Female (Silver) + LEDs (Orange/Green)	
LEDs	PDU/Phase / Bank	1 digit 7-segment (Orange)	
	PDU/Phase / Bank / IP	3 (Green)	
	Current / IP Address	3-digit 7-segment (Orange)	
	Output Power Indicator	1 (Red)	
	Power	1 (Blue)	
	LAN	10/100M	1 (Orange / Green)
		Link	1 (Green)
Sensor		2 (Green)	
Switches	Reset	1 x Semi-recessed Pushbutton	
Button		1 x Pushbutton	
I/P Rating		100–120V~; 50-60 Hz; 20A (Max); 16A (UL de-rated)	
Power Capacity		2400 VA (Max); 1920 VA (UL de-rated)	
O/P Rating	Per Port	NEMA 5-20R: 20A (Max); 16A(UL de-rated)	
	Per Bank	20A (Max); 16A (UL de-rated)	
	Total	20A (Max); 16A (UL de-rated)	
Environment	Operating Temperature	0–50°C	
	Storage Temperature	-20–60°C	
	Humidity	0–80% RH Non-condensing	
Physical Properties	Housing	Metal	
	Weight	3.93 kg	
	Dimensions (L x W x H)	177.5 x 5.6 x 4.8 cm	

PE5224TA - Japan

Function	PE5224TA	
電源仕様	入力定格電力	100 - 120 VAC
	最大入力電流	16A (最大)
	入力周波数	50-60 Hz
	電源入力プラグ	NEMA 5-20P
	最大入力電力	2400 VA (最大)
	アウトレット形状	合計 : NEMA 5-20R x 24
		バンク 1-1 : アウトレット番号 1 - 12; NEMA 5-20R x 12
		バンク 1-2 : アウトレット番号 13 - 24; NEMA 5-20R x 12
	出力定格電力	100 - 120 VAC
	最大出力電流 (アウトレット)	NEMA 5-20R: 16A (最大)
	最大出力電流 (バンク)	16A (最大)
	最大出力電流 (合計)	16A (最大)
	計測項目	バンクレベルでの電流、電圧、VA、PF および kWh 計測
	電源切替操作	非対応
	環境センサー用ポート数	2
	計測精度	電圧 : 100VAC ~ 250VAC +/-1%
電力 : 100W ~ Maximum Capacity +/- 2%		
電流 : 0.1A~1A +/- 0.1A, 1A~20A +/-1%		
物理仕様	サイズ (L x W x H)	177.5 x 5.6 x 4.8 cm
	重量	3.93 kg
	電源ケーブル長	3 m
動作環境	温度 (操作 / 保管)	0-50° C / -20-60° C
	湿度 (操作および保管)	0-80% RH、結露無きこと

PE5324TA

Function		PE5324TA	
Power Outlets	Direct	24	
Connectors	Power Cord	1 x NEMA L5-30P	
	Power Outlets	Total: 24 x NEMA 5-20R Bank 1: Outlet 1–12; 12 x NEMA 5-20R Bank 2: Outlet 13–24; 12 x NEMA 5-20R	
	Sensor	2 x RJ-11	
	LAN	1 x RJ-45 Female (Silver) + LEDs (Orange/Green)	
LEDs	PDU/Phase / Bank	1 digit 7-segment (Orange)	
	PDU/Phase / Bank / IP	3 (Green)	
	Current / IP Address	3-digit 7-segment (Orange)	
	Output Power Indicator	2 (Red)	
	Power	1 (Blue)	
	LAN	10/100M	1 (Orange / Green)
		Link	1 (Green)
Sensor	2 (Green)		
Switches	Reset	1 x Semi-recessed Pushbutton	
	Power	2 x 16A Slim Breakers	
Button		1 x Pushbutton	
I/P Rating		100–120V~; 50-60 Hz; 30A (Max), 24A (UL De-rated)	
Power Capacity		3600 VA (Max)	
O/P Rating	Per Port	NEMA 5-20R: 15A (Max); 12A (UL De-rated)	
	Per Bank	15A (Max); 12A (UL De-rated)	
	Total	30A (Max); 24A (UL De-rated)	
Environment	Operating Temperature	0–50°C	
	Storage Temperature	-20–60°C	
	Humidity	0–80% RH Non-condensing	
Physical Properties	Housing	Metal	
	Weight	4.95 kg	
	Dimensions (L x W x H)	177.5 x 5.6 x 4.8 cm	

PE5324TA - Japan

	Function	PE5324TA
電源仕様	入力定格電力	100 ~ 120VAC
	最大入力電流	30A (最大)、24A (UL ディレーティング)
	入力周波数	50 ~ 60Hz
	電源入力プラグ	NEMA L5-30P
	最大入力電力	3600VA
	アウトレット形状	合計 : NEMA 5-20R × 24 バンク 1 : アウトレット番号 1 ~ 12; NEMA 5-20R × 12 バンク 2 : アウトレット番号 13 ~ 24; NEMA 5-20R × 12
	出力定格電力	100 ~ 120 VAC
	最大出力電流 (アウトレット)	NEMA 5-20R: 15A (最大)、12A (UL ディレーティング)
	最大出力電流 (バンク)	15A (最大)、12A (UL ディレーティング)
	最大出力電流 (合計)	30A (最大)、12A (UL ディレーティング)
	ブレーカー	16A スリムブレーカー × 2
	計測項目	バンクレベルでの電流、電圧、VA、PF および kWh 計測
	電源切替操作	非対応
	環境センサー用ポート数	2
計測精度	電圧 : 100VAC ~ 250VAC +/-1% 電力 : 100W ~ Maximum Capacity +/- 2% 電流 : 0.1A~1A +/- 0.1A, 1A~20A +/-1%	
物理仕様	サイズ (W×D×H)	48×56×1775mm
	重量	6.3 / 4.95 kg
	電源ケーブル長	3m
動作環境	温度 (操作 / 保管)	0 ~ 50° C / -20 ~ 60° C
	湿度 (操作および保管)	0 ~ 80%、結露無きこと

PE5342TB

Function		PE5342TB	
Power Outlets	Direct	42	
Connectors	Power Cord	1 x NEMA L6-30P	
	Power Outlets	Total: 36 x IEC320 C13 + 6 x IEC320 C19 Bank 1: Outlet 1–21; 18 x C13 + 3 x C19 Bank 2: Outlet 22–42; 18 x C13 + 3 x C19	
	Sensor	2 x RJ-11	
	LAN	1 x RJ-45 Female (Silver) + LEDs (Orange/Green)	
LEDs	PDU/Phase / Bank	1 digit 7-segment (Orange)	
	PDU/Phase / Bank / IP	3 (Green)	
	Current / IP Address	3-digit 7-segment (Orange)	
	Output Power Indicator	2 (Red)	
	Power	1 (Blue)	
	LAN	10/100M	1 (Orange / Green)
		Link	1 (Green)
Sensor	2 (Green)		
Switches	Reset	1 x Semi-recessed Pushbutton	
	Power	2 x 16A Slim Breakers	
Button		1 x Pushbutton	
I/P Rating		100–240V~; 50–60 Hz; 30A (Max), 24A (UL)	
Power Capacity		6240 VA (Max)	
O/P Rating	Per Port	C13	Duplex Receptacles: 15A (Max); 12A (UL De-rated)
		C19	15A (Max); 12A (UL De-rated)
	Per Bank		15A (Max); 12A (UL De-rated)
	Total		30A (Max); 24A (UL De-rated)
Environment	Operating Temperature		0–50°C
	Storage Temperature		-20–60°C
	Humidity		0–80% RH Non-condensing
Physical Properties	Housing		Metal
	Weight		6.01 kg
	Dimensions (L x W x H)		177.5 x 5.6 x 4.8 cm

PE5342TB - Japan

Function	PE5342TB	
電源仕様	入力定格電力	100 ~ 240VAC
	最大入力電流	30A (最大)、24A (UL ディレーティング)
	入力周波数	50 ~ 60Hz
	電源入力プラグ	NEMA L6-30P
	最大入力電力	6240VA
	アウトレット形状	合計 : IEC320 C13 二重レセプタクル × 36 + IEC320 C19 × 6 バンク 1 : アウトレット番号 1 ~ 21; IEC320 C13二重レセプタクル × 18 + IEC320 C19 × 3 バンク 2 : アウトレット番号 22 ~ 42; IEC320 C13 二重レセプタク ル × 18 + IEC320 C19 × 3
	出力定格電力	100 ~ 240 VAC
	最大出力電流 (ア ウトレット)	IEC320 C13 二重レセプタクル: 15A (最 大)、12A (UL ディレーティング) IEC320 C19: 15A (最大)、12A (UL ディ レーティング)
	最大出力電流 (バ ンク)	15A (最大)、12A (UL ディレーティング)
	最大出力電流 (合 計)	30A (最大)、24A (UL ディレーティング)
	ブレーカー	16A スリムブレーカー × 2
	計測項目	バンクレベルでの電流、電圧、VA、PF お よび kWh 計測
	電源切替操作	非対応
環境センサー用 ポート数	2	
計測精度	電圧 : 100VAC ~ 250VAC +/-1% 電力 : 100W ~ 最大容量 +/- 2% 電流 : 0.1A ~ 1A +/- 0.1A、1A ~ 20A +/-1%	
物理仕様	サイズ (W×D×H)	48×56×1775mm
	重量	6.3 / 6.01 kg
	電源ケーブル長	3m
動作環境	温度 (操作 / 保 管)	0 ~ 50° C / -20 ~ 60° C
	湿度 (操作および 保管)	0-80% RH、結露無きこと

PE5342TG

Function		PE5342TG	
Power Outlets	Direct	42	
Connectors	Power Cord	1 x IEC 60309 32A	
	Power Outlets	Total: 36 x IEC320 C13 + 6 x IEC320 C19 Bank 1: Outlet 1–21; 18 x C13 + 3 x C19 Bank 2: Outlet 22–42; 18 x C13 + 3 x C19	
	Sensor	2 x RJ-11	
	LAN	1 x RJ-45 Female (Silver) + LEDs (Orange/Green)	
LEDs	PDU/Phase / Bank		1 digit 7-segment (Orange)
	PDU/Phase / Bank / IP		3 (Green)
	Current / IP Address		3-digit 7-segment (Orange)
	Output Power Indicator		2 (Red)
	Power		1 (Blue)
	LAN	10/100M	1 (Orange / Green)
		Link	1 (Green)
Sensor		2 (Green)	
Switches	Reset	1 x Semi-recessed Pushbutton	
	Power	2 x 16A Slim Breakers	
Button		1 x Pushbutton	
I/P Rating		100–240V~; 50–60Hz; 32A (Max)	
Power Capacity		7360 VA (Max)	
O/P Rating	Per Port	C13	Duplex Receptacles: 10A (Max)
		C19	16A (Max)
	Per Bank		16 (Max)
	Total		32A (Max)
Environment	Operating Temperature		0–40°C
	Storage Temperature		-20–60°C
	Humidity		0–80% RH Non-condensing
Physical Properties	Housing		Metal
	Weight		5.57 kg
	Dimensions (L x W x H)		177.5 x 5.6 x 4.8 cm

Administrator Login Failure

If you are unable to perform an Administrator login (because the Username and Password information has become corrupted, or you have forgotten it, for example), you can clear the login information with the following procedure:

1. Power off the eco PDU and remove its housing.
2. Short the jumper labeled J2 (PIN1 and PIN2).

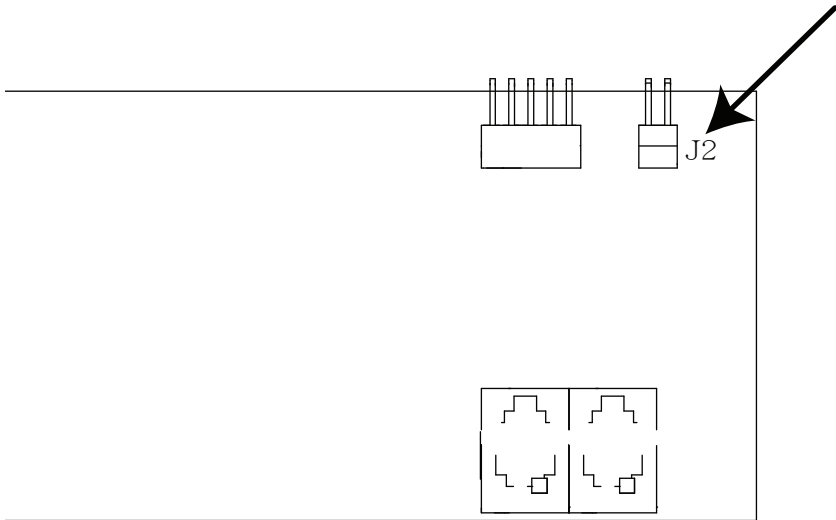

3. Power on the eco PDU.
4. After the beep indicates successfully powered on, power off the switch.
5. Remove the jumper cap from J2.
6. Close the housing and start the eco PDU.

After you start, you can use the default Username and Password to log in.

Limited Warranty

ATEN warrants its hardware in the country of purchase against flaws in materials and workmanship for a Warranty Period of two [2] years (warranty period may vary in certain regions/countries) commencing on the date of original purchase. This warranty period includes the [LCD panel of ATEN LCD KVM switches](#). Select products are warranted for an additional year (see [A+ Warranty](#) for further details). Cables and accessories are not covered by the Standard Warranty.

What is covered by the Limited Hardware Warranty

ATEN will provide a repair service, without charge, during the Warranty Period. If a product is defective, ATEN will, at its discretion, have the option to (1) repair said product with new or repaired components, or (2) replace the entire product with an identical product or with a similar product which fulfills the same function as the defective product. Replaced products assume the warranty of the original product for the remaining period or a period of 90 days, whichever is longer. When the products or components are replaced, the replacing articles shall become customer property and the replaced articles shall become the property of ATEN.

To learn more about our warranty policies, please visit our website:
<http://www.aten.com/global/en/legal/policies/warranty-policy/>

© Copyright 2021 ATEN® International Co., Ltd.
Released: 2021-05-25

ATEN and the ATEN logo are registered trademarks of ATEN International Co., Ltd. All rights reserved. All other brand names and trademarks are the registered property of their respective owners.